

Workshop Manual

944

DR. ING. h. c. F. PORSCHE Aktiengesellschaft

List of Repair Groups 944

General	Technical Data	Page 0.1
Repair Groups		Group
	Maintenance, Self-diagnosis	03
Engine	Engine, Crankcase	10
	Engine, Crankshaft, Pistons	13
	Engine, Cylinder Head and Valve Drive	15
	Engine, Lubrication	17
	Engine, Cooling	19
	Fuel Supply	20
	Air Flow Controlled Fuel Injection	24
	Exhaust System/Emission Controls	26
	Starter, Power Supply, Cruise Control	27
	Ignition System	28
	DME Diagnosis	
Transmission	Clutch, Controls	30
	Torque Converter	32
	Manual Transmission, Controls, Case	34
	Manual Transmission, Gears, Shafts	35
	Automatic Transmission, Controls, Case	37
	Automatic Transmission, Gears, Valve Body	38
	Differential, Transaxle System	39
Chassis	Front Wheel Suspension	40
	Rear Wheel Suspension, Axle Shaft	42
	Wheels, Tires, Alignment	44
	Antiblock System	45
	Brakes, Mechanical	46
	Brakes, Hydraulics, Regulator, Booster	47
	Steering	48
Body	Body-Front Section	50
	Body-Center Section	51
	Body-Rear Section	53
	Lids	55
	Doors	57
	Hardtop	61
	Bumpers	63
	Glasses, Window Control	64
	Exterior Equipment	66
	Interior Equipment	68
	Seats	72
	Seat Covers	74
	Airbag Diagnosis	
Heating, Ventilation, Air Condition	Heater	80
	Ventilation	85
	Air Conditioner	87
Electrics	Instruments, Fuel Gauge, Alarm System	90
	Radio, Telephone	91
	Windshield Wipers and Washer	92
	Exterior Lights, Lamps, Switches	94
	Interior Lights	96
	Wiring	97

	Page
Instruments, Consumption indicators, Burglar alarm	
Fuel consumption indicator, upshift indicator	90 - 1
Troubleshooting - fuel consumption indicator	90 - 2
Troubleshooting - upshift indicator	90 - 3
Relay arrangement, Model 84 onward	90 - 5
Fuses in central electric system, Model 84 onward	90 - 7
Fuses in auxiliary fuse box, Model 84 onward	90 - 8
Instrument cluster, Model 85/2 onward	90 - 9
Instrument cluster, removing and installing, Model 85/2 onward	90 - 13
Sensor for speedometer, removing and installing	90 - 14
Checking instruments	90 - 15
Checking burglar alarm	90 - 19
Checking auxiliary control unit, burglar alarm	90 - 20
Radio, Telephone, On-board computer	
Retrofitting radio in vehicles prepared for radio installation from Model 85/2 onward	91 - 1
Connections in vehicles prepared for radio installation from Model 86 onward	91 - 3
Preparatory equipment for telephone	91 - 5
Retrofitting CD player, Model 89 onward	91 - 15
Windshield wipers and washer	
Windshield wiper/washer, removing and installing, Model 85/2 onward	92 - 1
Electric pump for windshield washer system, removing and installing	92 - 2
Exterior lights	
Lubricating concealed-headlight linkage	94 - 1
Switch covers, removing and installing, Model 85/2 onwards	94 - 3
Lock cylinder, removing and installing, Model 85/2 onward	94 - 5
Beam control, removing and installing actuator	94 - 7
Checking beam control	94 - 8
Adjusting headlamps with beam control	94 - 9
Wiring	
Central electric system, removing and installing, Model 85/2 onward	97 - 01
Central electric system, assignment	97 - 03
Cable-harness modification	97 - 04
Supplementary electrical equipment	97 - 05

	Page
Current-flow diagram - Type 944 Model 82	97 - 1
Current-flow diagram - Type 944 Model 83	97 - 19
Current-flow diagram - Type 944 Model 84	97 - 33
Circuit diagram - Type 944; 944 turbo 85/2	97 - 52 A
Circuit diagram - Type 944; 944 turbo, Model 86	97 - 71
Circuit diagram - Type 944, 944 turbo, 944 S, Model 87	97 - 97
Circuit diagram - Type 924 S, Model 86	97 - 499
Circuit diagram - Type 924 S, Model 87	97 - 515

ECONOMY CONTROL

UPSHIFT INDICATOR

(Extra for USA Cars with Manual Transmission)

Description and Troubleshooting

Both systems are integrated in the tachometer.

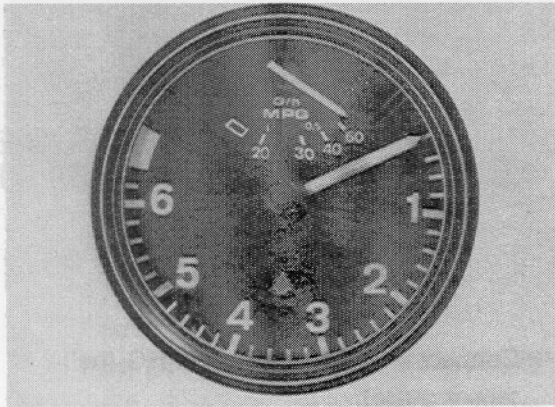

Economy Control

The economy control displays the instantaneous fuel consumption in ltr./100 km (miles per gallon) or ltr./hour (gallons per hour) depending on road speed and injection time (t_i = signal of fuel injectors).

Upshift Indicator

The upshift indicator lights up when it is practicle and economical to shift up into the next higher gear. It works in gears 1 through 4 and remains on until the next higher gear is selected or the operating condition causing display changes (e. g. coasting, full throttle, etc.).

The indicator lamp is designed for good recognition in daylight and will have less brightness when main lights are switched on.

The electronic control for both systems is housed in the tachometer and, as also the indicator lamp, cannot be replaced separately.

Signals Required for Operation

- Economy Control — Road speed (hall sensor signal) from speedometer
- Injection signal (t_i signal) from DME control unit
- Upshift Indicator — Engine speed (ignition term. 1)
- Coolant temperature
 - Road speed (hall sensor signal) from speedometer
 - Injection time (t_i signal) from DME control unit

TROUBLESHOOTING ECONOMY CONTROL

1. Check voltage on two-pin plug next to the DME control unit.



A = Plug for economy control and upshift indicator (square version)

B = Plug for altitude correction box USA (round version)

Term. 1 (black wire) should have battery voltage with ignition turned on.

2. Term. 2 of two-pin plug will have the injection signal with the engine running and it can be seen with help of an oscilloscope.
The injection signal is a square-wave signal, which increases in width as speed picks up.

3. The tachometer must be removed (plugs remain connected) to measure the hall sensor signals in the speedometer.
Term. 5 and H + should have battery voltage with ignition turned on.

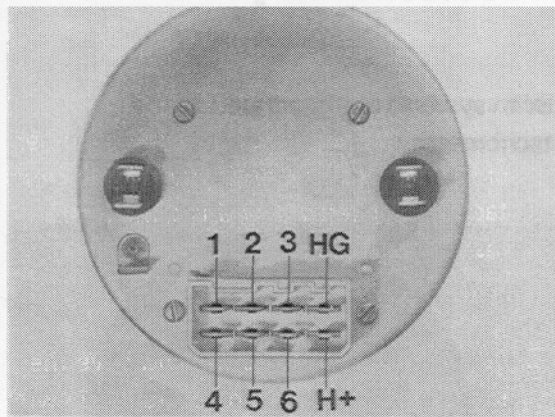

4. Connect voltmeter on term. HG (hall sensor pulse).
Lift and turn left front wheel slowly by hand.
Voltage should rise and drop four times from less than 1 volt to more than 6 volts for each wheel revolution (square-wave pulses).

TRUBLESHOOTING UPSHIFT INDICATOR

If the upshift indicator malfunctions, perform same tests as for troubleshooting the economy control.

Additional Tests:

1. Coolant temperature gauge in instrument cluster must be okay. Signal comes from tachometer term. 4 and is sent to the instrument cluster.
2. Term. 6 of tachometer should have the ignition pulse (ignition coil term. 1) with the engine running.

If a defect is not found after troubleshooting the economy control or upshift indicator, check power flow in wires and contact of wires or, if necessary, replace tachometer.

RELAY ARRANGEMENT — Since 1984 Models

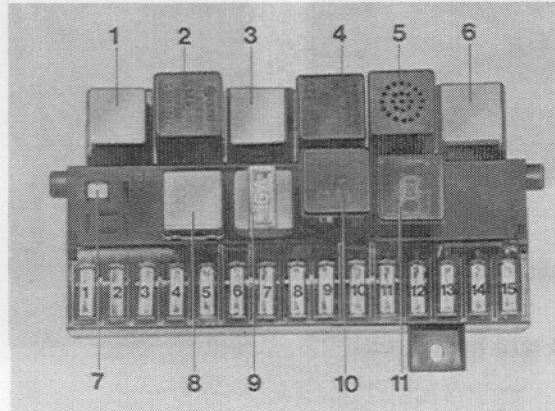

- | | |
|---|--------------------------------------|
| 1 — Relay for fan | 7 — Plug bridge
(term. 56 — 56 b) |
| 2 — Relay for fuel pump | 8 — Relay for additional high beams |
| 3 — Relay for blower | 9 — Relay for horns |
| *4 — Relay for headlight cleaners | 10 — Relay for intermittent action |
| *5 — Warning time relay with gong (USA)
Catalytic converter monitoring
control unit (Japan) | 11 — Relay for flashing lights |
| 6 — Relay for rear window defogger and
seat belts | |

* Relays 4 and 5 changed since December, 1983

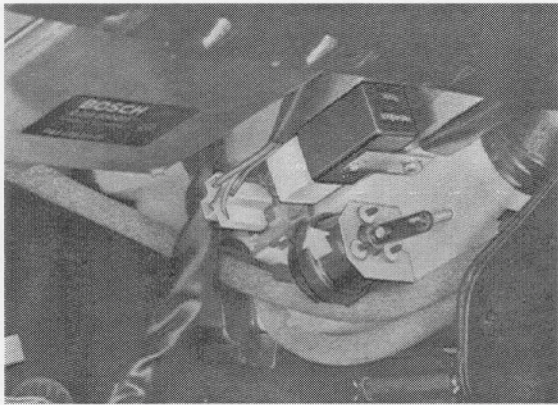

- Relay for power windows
- Relay for radio or radio and lifting roof

Installation Point:

Center console at bottom left behind trim.

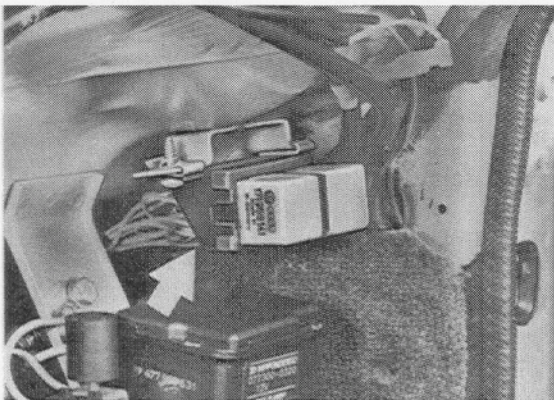

- Relay for air conditioner
- Relay for blower shutoff

Installation Point:

Below glove box of trim panel behind knee guard.

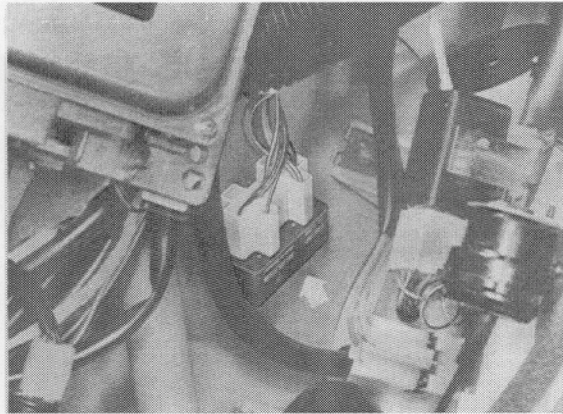

- Relay for front fog lamps

Installation Point:

Underneath instrument panel next to steering column.

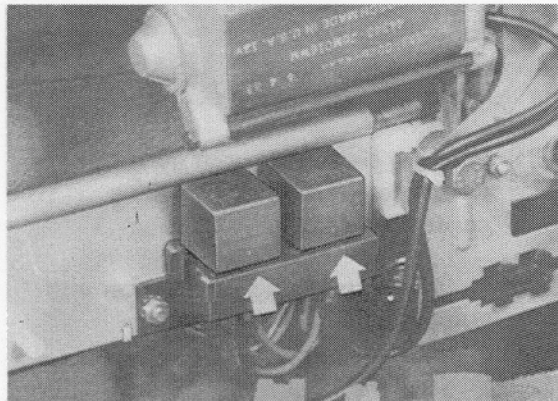

- Relay for lifting roof

Installation Point:

In luggage compartment on left side behind trim panel.

· FUSES ON CENTRAL ELECTRIC BOARD –
Since 1984 Models

No.	Equipment	Amperes
1	Low beam, left	8
2	Low beam, right	8
3	High beam, left	8
4	High beam, right	8
5	Additional high beams	16
6	Hazard lights	8
7	Radio, clock, cigar lighter, inside lights	8
8	Stop lights	8
9	Backup lights, turn signal indicator lamps, outside mirror motor	8
10	Outside mirror heating, control wire for rear window defogger	16
11	Windshield wipers	8
12	Instrument lights, glove box light, ashtray light, license plate lights	8
13	Marker light, right	8
14	Marker light, left	8
15	Front fog lamps	16

FUSES IN AUXILIARY FUSE BOX —
Since 1984 Models

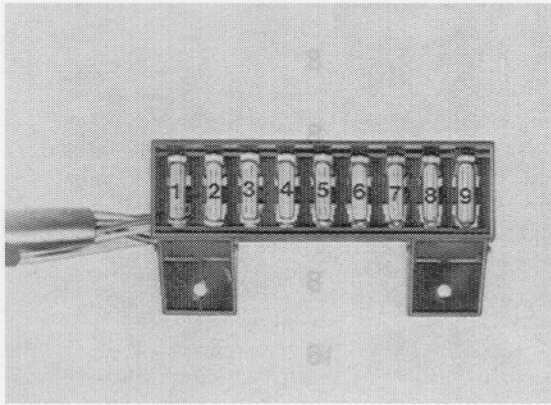

No.	Equipment	Amperes
1	Concealed headlight motor	16
2	Fuel pump	16
3	Blower motor	16
4	Rear window defogger	25
5	Condenser fan (air conditioner)	16
6	Compressor, evaporator fan	25
7	Rear fog light	8
8	Power windows	16
9	Blower, tailgate unlocking motor	25

INSTRUMENT CLUSTER SINCE 1985/2 MODELS

INSTRUMENT CLUSTER SINCE 1985/2 MODELS

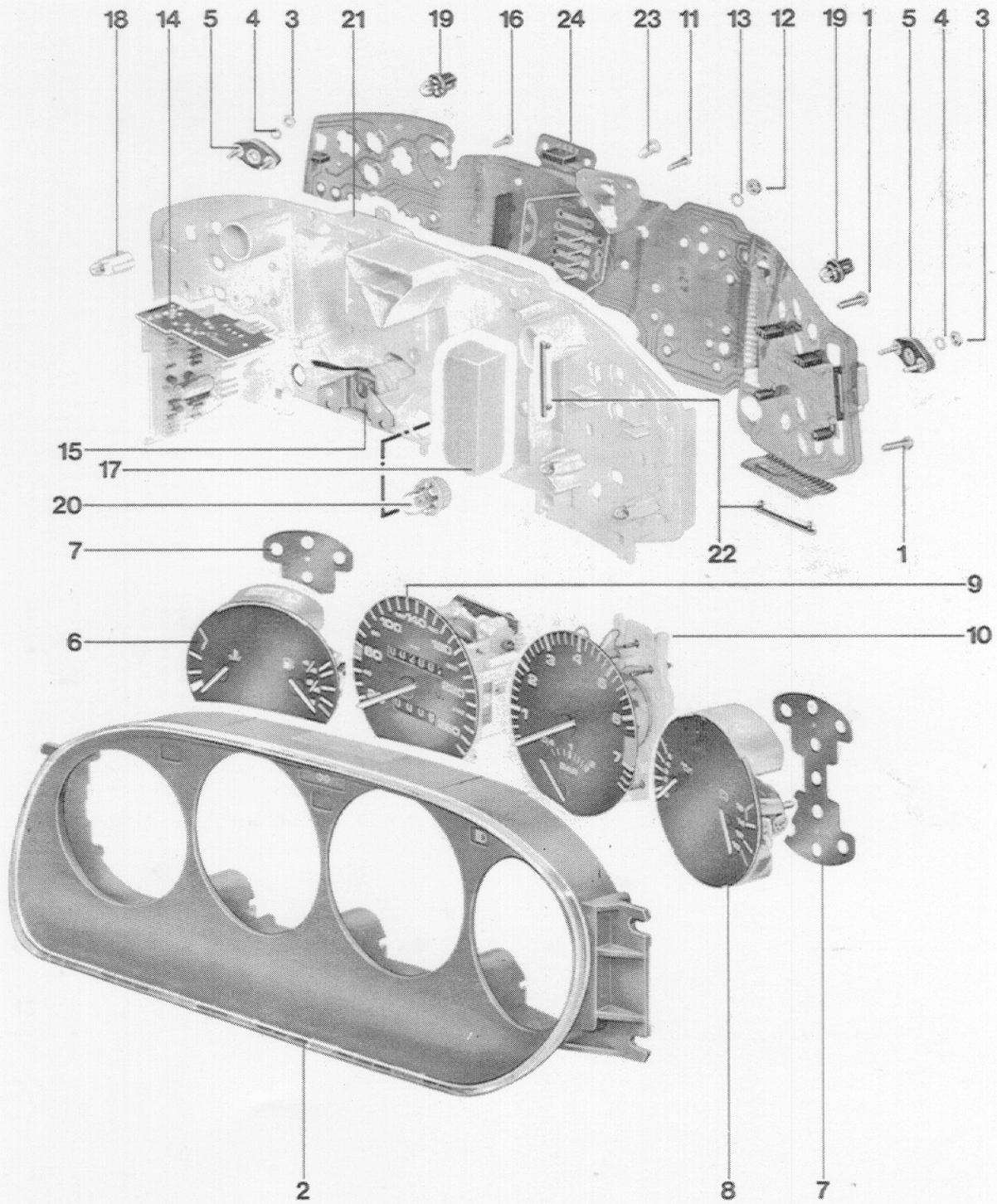

No.	Description	Qty.	Note When:		Special Instructions
			Removing	Installing	
1	Phillips screw	9			
2	Housing	1			
3	Nut	4			
4	Washer	4			
5	Plug connector	4			
6	Temperature/fuel gage	1			
7	Gasket	2			
8	Voltmeter/oil pressure gage	1			
9	Speedometer	1	Take out carefully		
10	Tachometer	1			
11	Bolt (long)	7			
12	Nut	5			
13	Washer	5			
14	Printed circuit board	1			
15	Solenoid	1	Unweld spots carefully	Cement, if necessary	
16	Bolt (short)	2			
17	Foam rubber	1			
18	Light bulb with holder	4			1.2 W
19	Light bulb with holder	16			1.2 W

No.	Description	Qty.	Note When:		Special Instructions
			Removing	Installing	
20	Light bulb with holder	3			2 W
21	Instrument carrier plate	1			
22	Printed circuit terminal	3			
23	Printed circuit terminal	4			
24	Printed circuit	1			

REMOVING AND INSTALLING INSTRUMENT CLUSTER SINCE 1985/2 MODELS

1. Pull off cover plate by hand.
Unscrew nut and take off steering wheel.

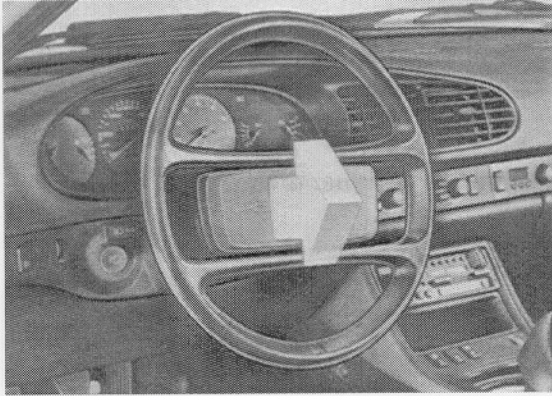

3. Unscrew mounting screws on instrument cluster.

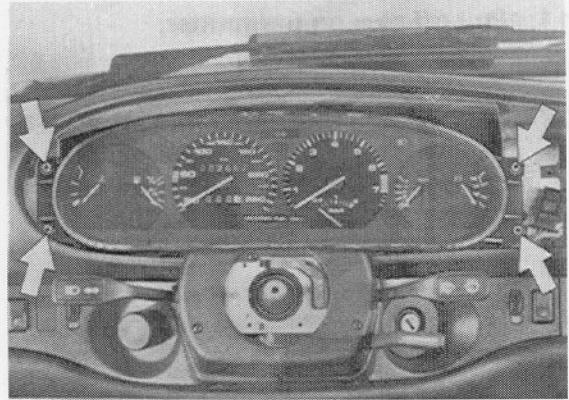

2. Unscrew and take off instrument cover.

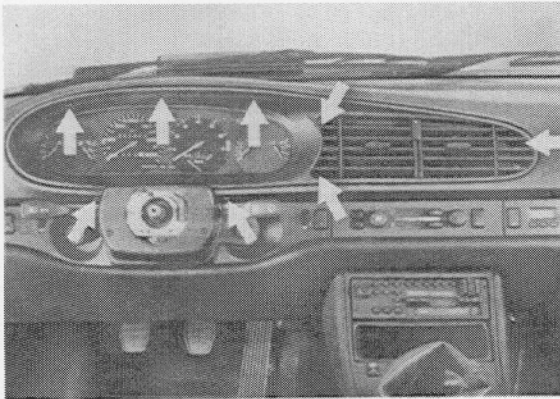

4. Unlock and take off plug connections on instrument cluster.

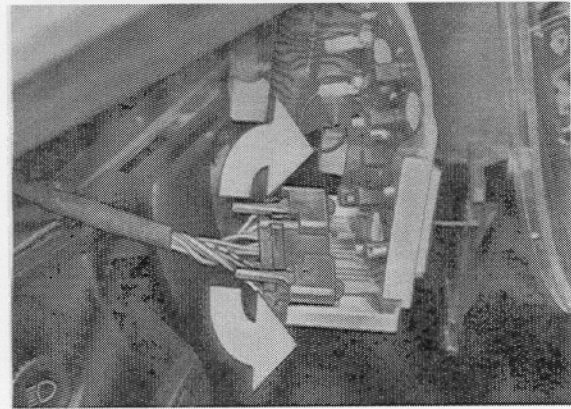

REMOVING AND INSTALLING TRANSMITTER FOR SPEEDOMETER

The transmitter is located on the left side of the transmission next to the axle shaft flange.

1. Pull off plug on transmitter.
2. Loosen and unscrew transmitter with a suitable tool. The bottom hexagon belongs to the mechanical drive of the transmitter.

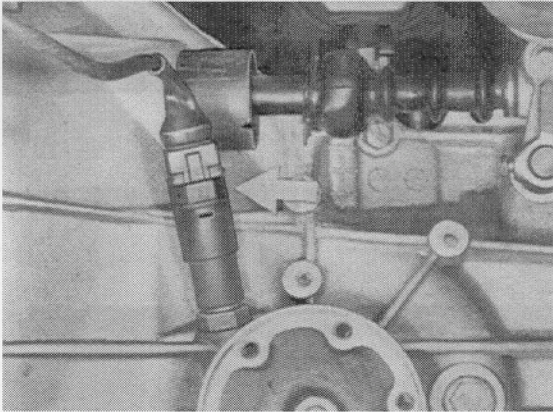
**Note**

Check specified tightening torque when tightening the transmitter.

Tightening torque: 4 Nm.

Checking the instruments

Models 82 - 85

You can check the indicators for coolant temperature, tank and oil pressure with the VAG 1301* test unit.

The connection cable must be disconnected from the relevant sensor for this.

The appropriate values are set on the test unit according to the following table. Switch on the ignition. If the instrument indicates the correct value, replace the sensor. If the instrument indicates an incorrect value or no value at all, check the cable to the instrument and replace the instrument if necessary. One pointer width to the right or left is a permissible deviation.

* See workshop manual Chapter 3 Groups 9/10.

Coolant temperature (°C)	Test unit setting	Resistance (Ω)
40	557 - 558	287.4
105	46 - 47	33.6
120	24 - 25	22.7

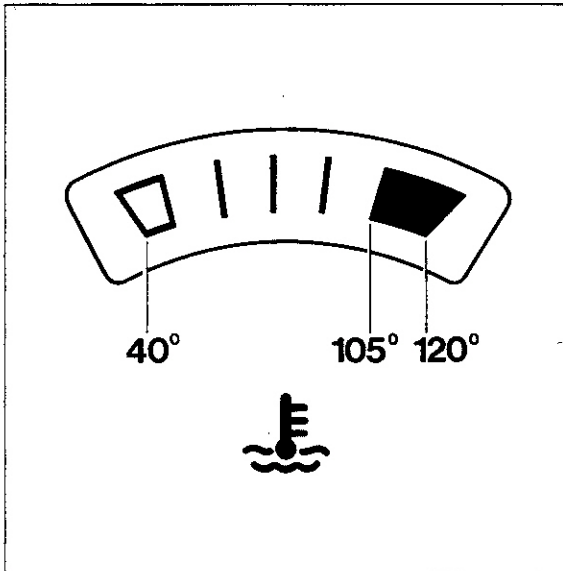

73/90

Tank	Test unit setting	Resistance (Ω)
RES	122 - 123	71.6
1/4	96 - 97	58.7
1/2	47 - 48	34.5
3/4	9 - 10	15,3
1/1	No setting possible	3.2
Oil pressure (bar)		
0	No setting possible	10.0
3	212 - 213	116.0
5	349 - 350	184.0
As from Model 85/2		
Coolant temperature ($^{\circ}\text{C}$)		
40	557 - 558	287.4
60	247 - 248	134.0
80	117 - 118	69.1
100	55 - 56	38.5
115	30 - 31	25.8

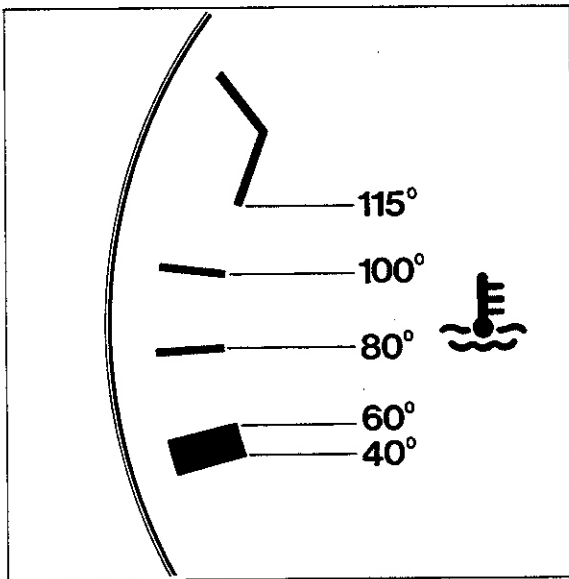

74/90

Tank	Test unit setting	Resistance (Ω)
RES	105 - 106	63.2
1/4	63 - 64	42.2
1/2	21 - 22	21.2
3/4	No setting possible	8.6
1/1	No setting possible	2.8
Oil pressure bar		
1	37 - 38	29.6
2	110 - 111	65.3
3	177 - 178	98.9
4	246 - 247	133.6
5	349 - 350	184.0

Checking burglar alarm

Model 89 onward

Note

The alarm control unit is located in the passenger's footwell behind the DEE control unit.

The following signals must be present at the alarm control unit terminals.

Input signals

1. Terminal 31: Ground
2. Terminal 30: Battery voltage
3. Terminal 15: Battery voltage with ignition switched on.
4. Terminal 61: Battery voltage with engine running.
5. Terminal T -: Ground with doors open or tail-gate open.
6. Terminal MK: Ground with engine hood open or radio removed.
7. Terminal A: Ground with key in the lock cylinder of doors turned in "open" direction.
8. Terminal E: Ground when lock cylinder turned towards "closed".

Output signals

1. Terminal 87 a: Battery voltage with ignition switched on.
2. Terminal Hn: Battery voltage clocked with burglar alarm primed and triggered (permanently in Swiss vehicles).

Note

There is a relay in base G 18 of the central electric system in USA vehicles which operates fog lamps and brake lamps as a visual warning in addition to the alarm horn.

Checking auxiliary control unit burglar alarm

Note

The auxiliary control unit is located in the central electric system.

Input signal

Check the input signal at the base, with relay removed.

1. Terminal 1: Ground with doors or tailgate open.
2. Terminal 3: Ground
3. Terminal 4: Battery voltage (Terminal 30)
4. Terminal 8: Ground with key in the lock cylinder (driver's or passenger's door) turned towards "closed" (only for as long as the lock cylinder is held in this position)
5. Terminal 9: Ground when the lock cylinder is turned towards "open".

Output signals

The output signals may only be checked with the relay fitted.

1. Terminal 2: Ground if
 - a) ground at terminal 8
 - b) burglar alarm primed approx. 25 seconds after closing tailgate (short pulse of approx. 0.5 seconds only).
2. Terminal 5: Battery voltage
3. Terminal 6: Ground if ground at terminal 9.

SERVICE INSTALLING RADIO SINCE 1985/2 MODELS PREPARED FOR RADIO INSTALLATION

1. Pull out tray holder and astray.



3. Remove mask on radio opening.

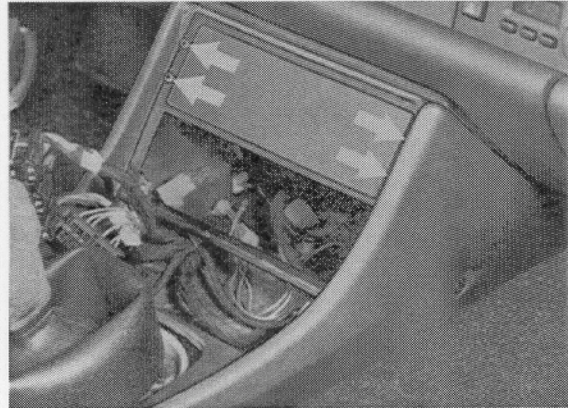

2. Unscrew mounting screws on cover frame of center console.

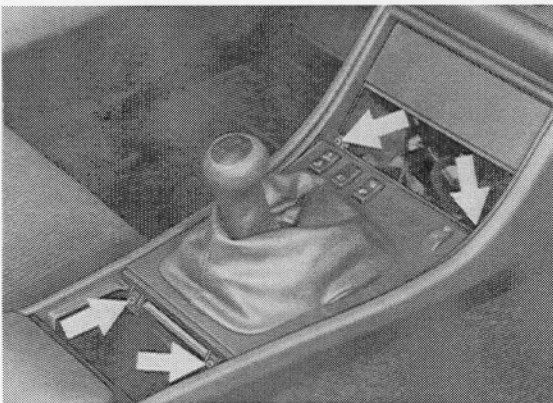

4. Insert holding frame for radio and bend in tabs with a screwdriver.

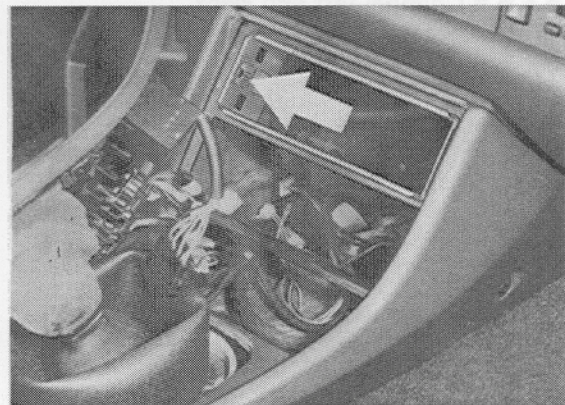

5. Connect radio.



1 = Positive (+) and ground (-) wired via the ignition lock.

2 = Constant positive (+) term. 30.

3 = Antenna connection.

4 = Antenna amplifier connection.

5 + 6 = Channel left and right.

CONNECTIONS IN MODELS PREPARED FOR RADIO FROM 1986

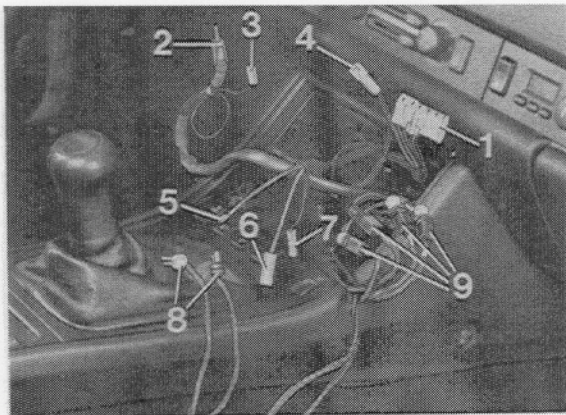

Plug assignment only with
Monterey SQ R 23

- Term.1 = Ground connection
- Term.2 = Ignition lock
- Term.3 = Lighting
- Term.4
= Bridged, automatic
antenna
- Term.5
- Term.6 = Permanent positive
term.30

1 Plug (6 pin) for radio power
supply

- 2 Antenna connection
- 3 Plug for antenna amplifier
- 4 Plug for automatic antenna/
antenna amplifier from radio
- 5 Ground connection
- 6 Permanent positive term.30
- 7 Automatic antenna/antenna ampli-
fier (radio positive output)
- 8 Speaker connection left and right
channel (2-channel radio)
- 9 Separating point for connecting
speakers to a 4-channel radio
(fading regulator is bypassed)

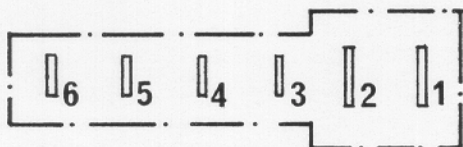

- Term.1 = Ground connection
- Term.2 = Ignition lock term. R
- Term.3 = Lighting (bridged
with automatic antenna)
- Term.4 = Automatic antenna
- Term.5 = Permanent positive term.30

N o t e

Connections 5,6,7 are provided for
the equalizer + power booster, but
can also be used for other
components.

Preparatory telephone equipment

M 195 Cellular telephone system

M 496 C network telephone system

As from Model 88, all 944 vehicles can be fitted with preparatory equipment for a telephone system.

This preparatory equipment comprises all necessary cable harnesses, brackets for the transceiver and controller as well as the telephone antenna.

Laying the cable harnesses in the vehicle

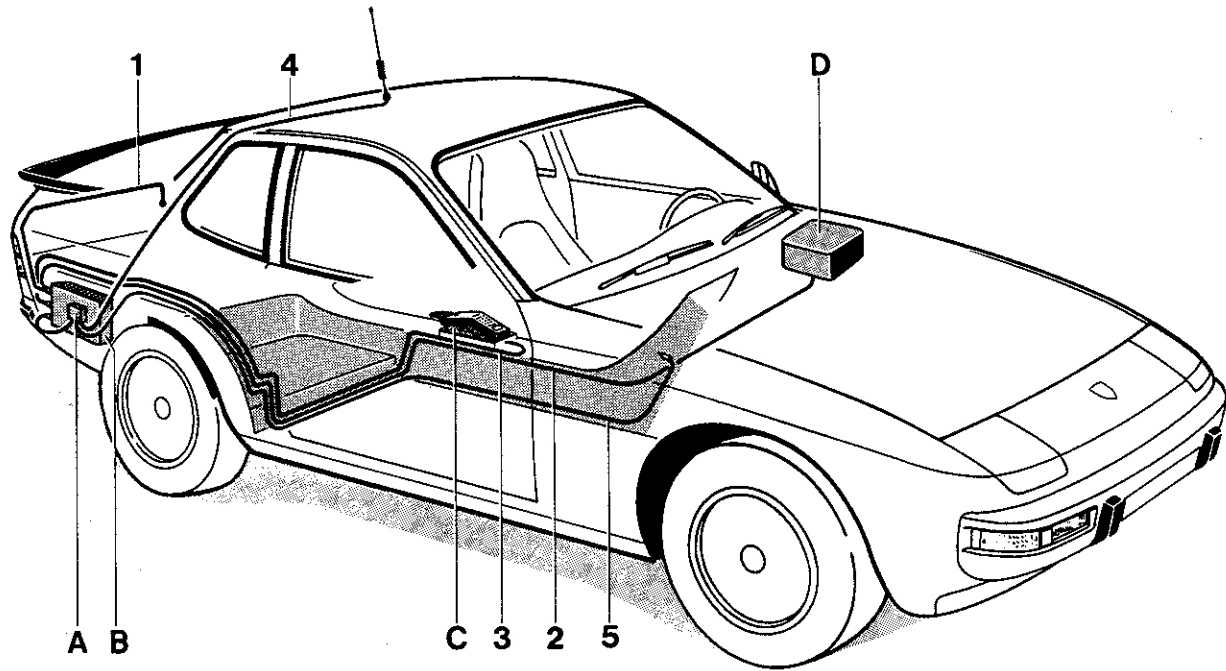

75/91

A - Antenna separating filter

B - Transceiver

C - Controller

D - Central electric system

1 - Terminal 31

2 - Terminals 15 and 30

3 - Controller lead

4 - Antenna lead

5 - Antenna lead, radio

Installing the transceiver

The transceiver is installed under a cover in the floor recess on the right-hand side to the rear of the luggage compartment.

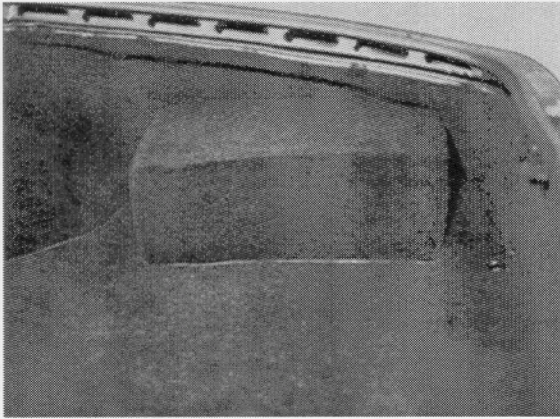

1.1 Bracket for the C network transceiver

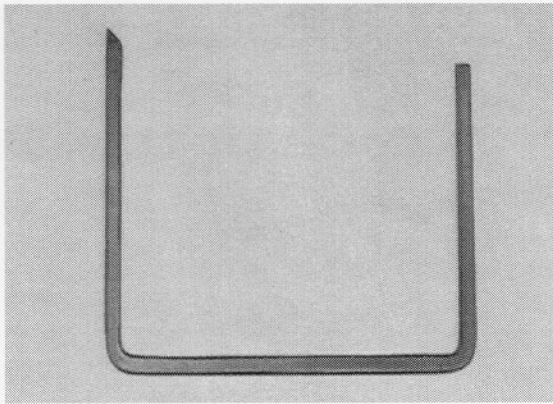

1.2 Bracket for the Cellular transceiver and threaded plate.

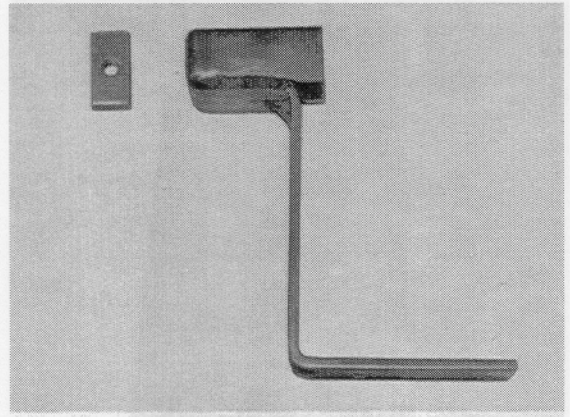

2.1 Mounting the universal holder on the C network bracket.

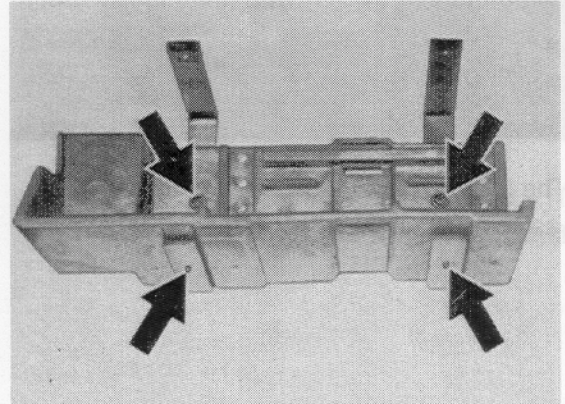

The universal holder is mounted on the 2 fastening brackets with 4 M 6 x 18 screws.

2.2 Mounting the universal holder on the Cellular fastening bracket.

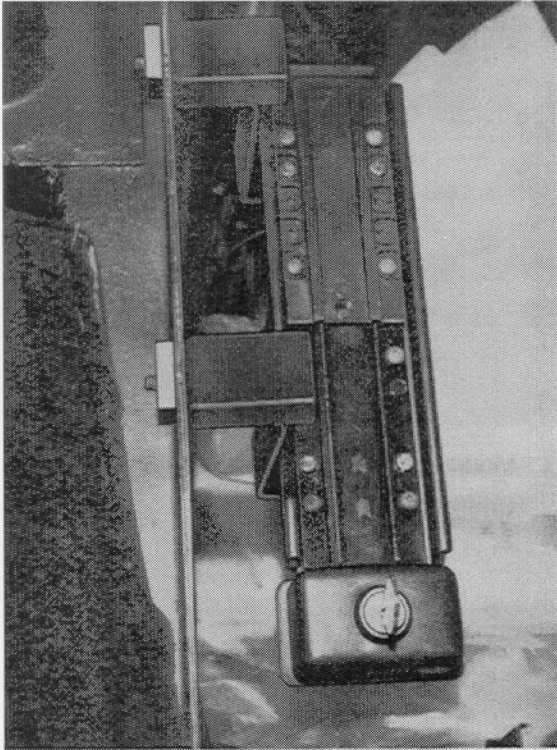

The universal holder is mounted to the fastening brackets with 4 M 4 x 10 screws.

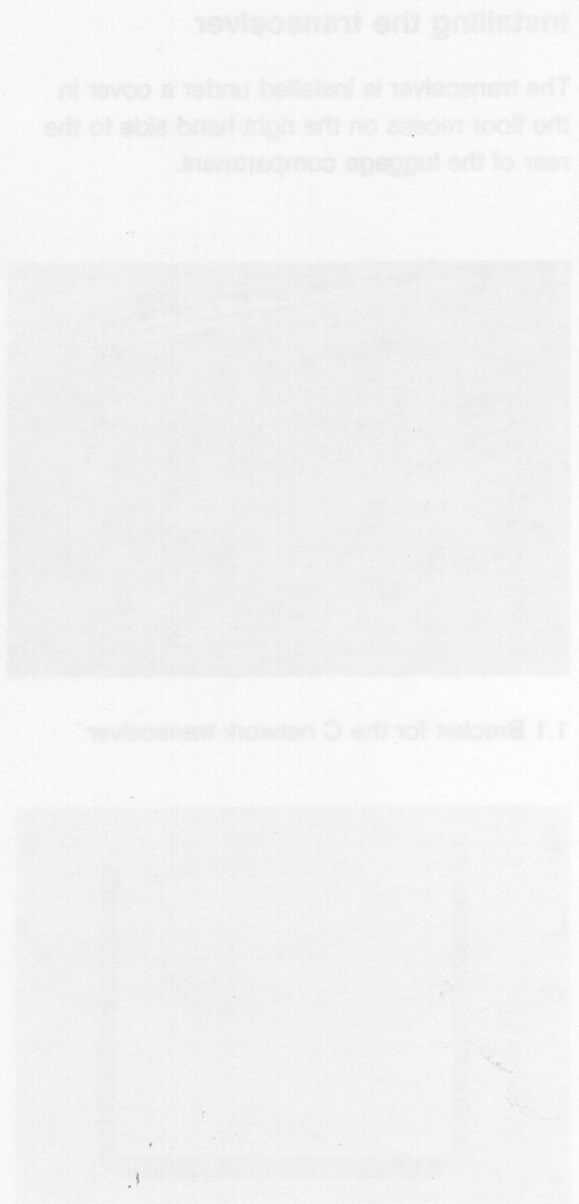

3. Mounting points in the vehicle

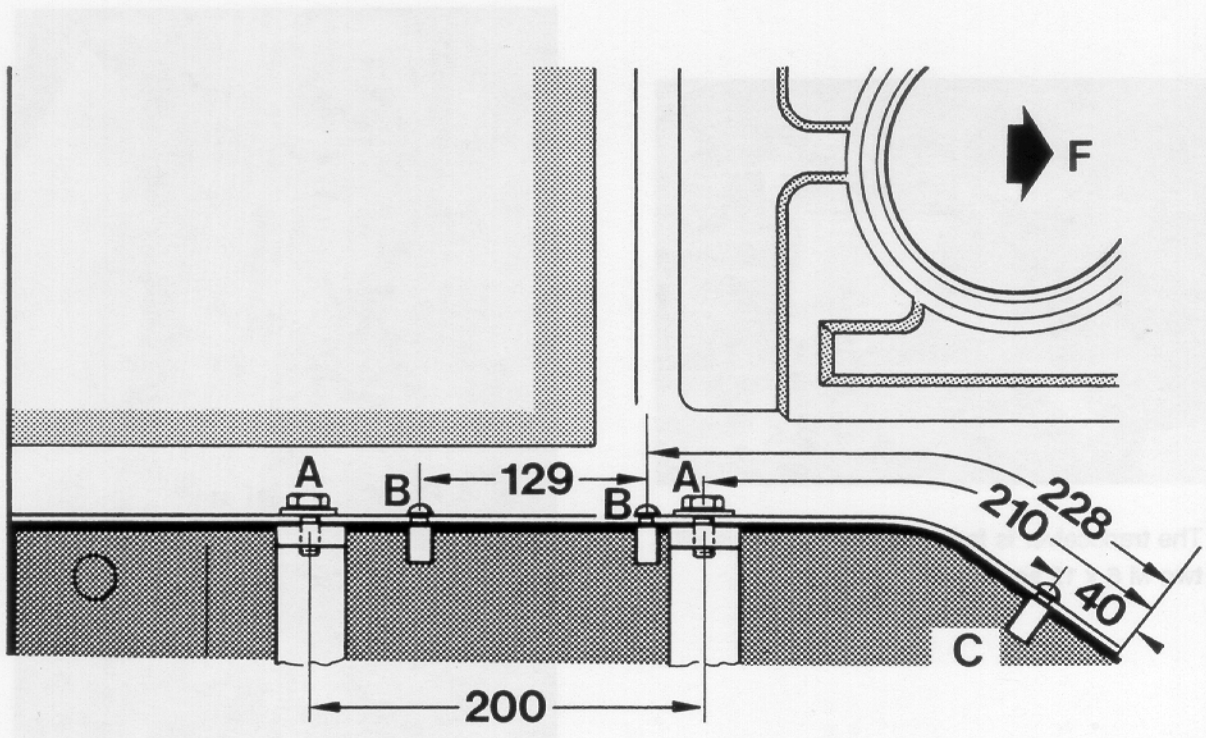

A - Mounting points for C network

B - Mounting points for Cellular

C - Cable clip

F - Direction of travel

Note

When installing the C network telephone system, the mounting points for the Cellular telephone system are used to fasten the cable with clips (as shown in the drawing). All 5 mounting points are drilled out to 6.5 mm.

76/91

4.1 Installing the transceiver for C network, stowing the excessive length of the cable harness.

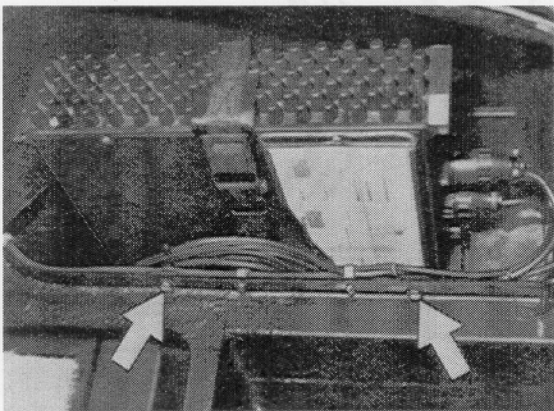

The transceiver is fastened to the chassis with two M 6 x 12 screws.

4.2 Installing the Cellular transceiver.

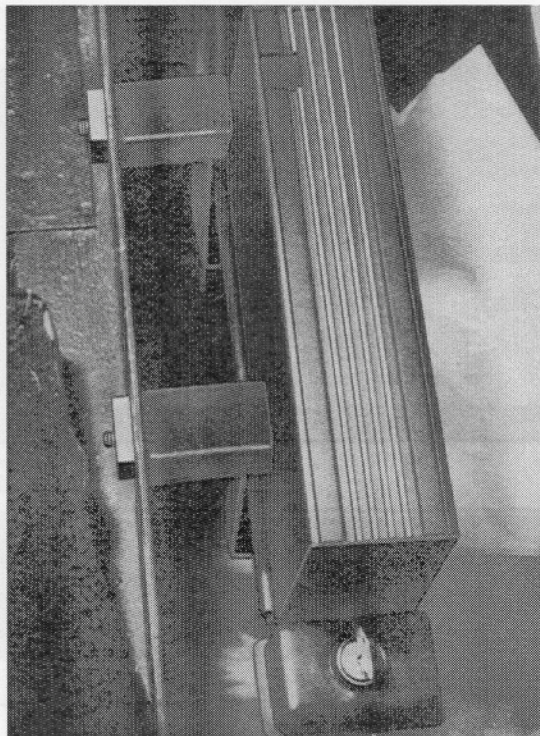

The transceiver is fastened to the chassis with two M 6 x 15 screws and two threaded plates.

Installing the antenna

The telephone antenna is mounted on the roof.

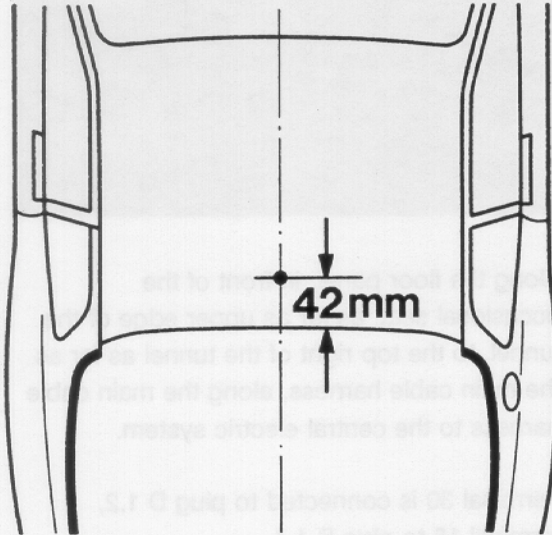

77/91

Installing the antenna separating filter

The antenna separating filter is only mounted with the C network telephone system.

The antenna separating filter is fastened to the right-hand side of the transceiver.

Laying the power supply leads

1. Ground lead

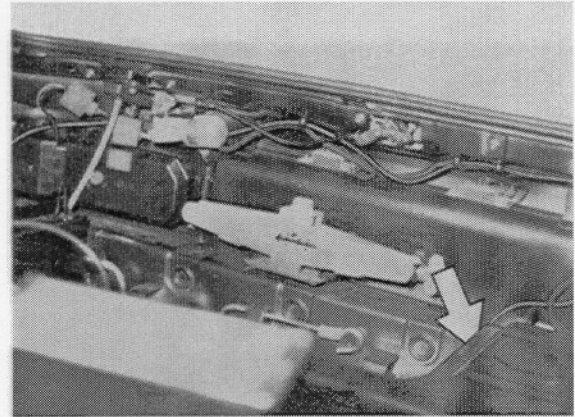

The ground lead is laid from the transceiver along the rear cableharness to the grounding point.

2. Plus supply terminals 30 and 15.

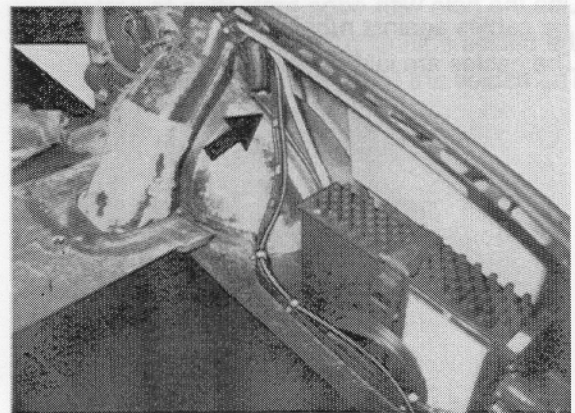

The plus lines are laid from the transceiver along the frame siderail, over the wheelhouse shell to the C column and to the B column.

Note

The stippled flange of the wheelhouse shell must be covered with edge protection to protect the cable against rubbing.

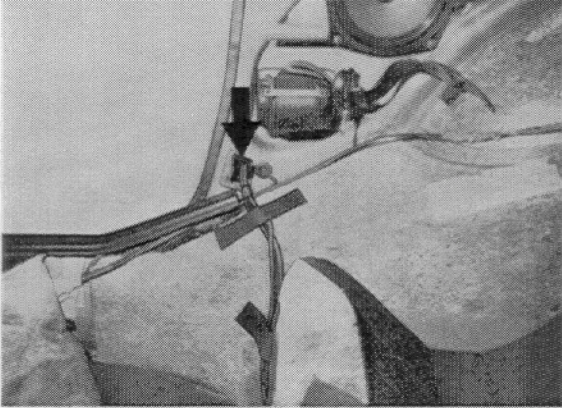

Through the existing hole in the B column into the interior of the vehicle as far as the floor panel.

Note

Line the hole with edge protection to protect the cables against rubbing.
The cables are laid under the insulation.

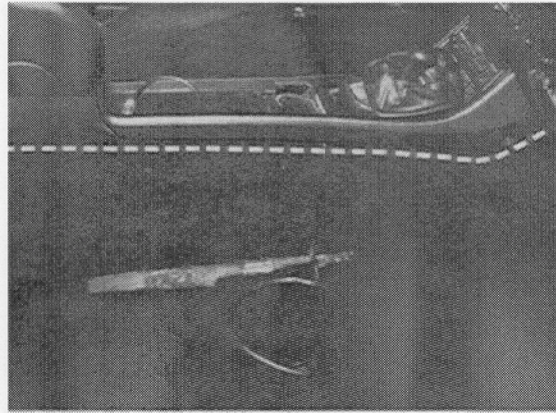

Along the floor panel, in front of the occasional seat, as far as upper edge of the tunnel, to the top right of the tunnel as far as the main cable harness, along the main cable harness to the central electric system.

Terminal 30 is connected to plug D 1.2,
terminal 15 to plug B 1.4.

3. Lead the cable harness from the transceiver to the controller.

Lay the cables parallel to the supply lines for the controller.

4. Antenna cable

For vehicles with folding roof: the antenna cable is fastened to the folding roof linkage with cable straps. The cables are laid from the roof antenna to the right-hand B column and to the antenna separating filter.

For vehicles without folding roof: the antenna cable is laid in the rear roof support.

5. Antenna cable for the radio.

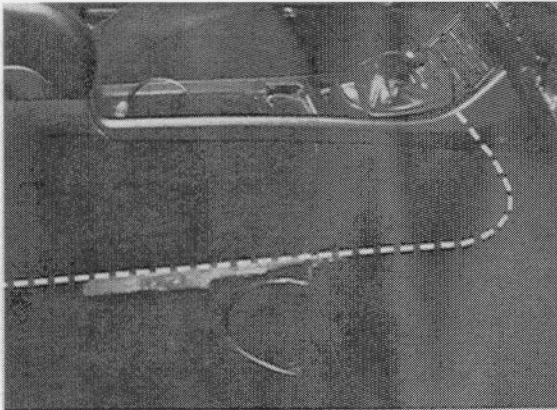

The antenna cable is laid from the antenna separating filter over the wheelhouse shell to the C column and to the B column. Through the existing hole in the B column into the interior of the vehicle as far as floor panel. On the floor panel, along the bottom edge of the tunnel to the radio.

Retrofitting CD player from Model 89 onwards

Vehicles fitted with preparatory radio equipment

Note

The CD player may only be operated with an equalizer.

1. Remove shelf from central console (may no longer be used as the equalizer is installed in this position).
2. Secure the equalizer's support spring to the bracket fitted for the central console.

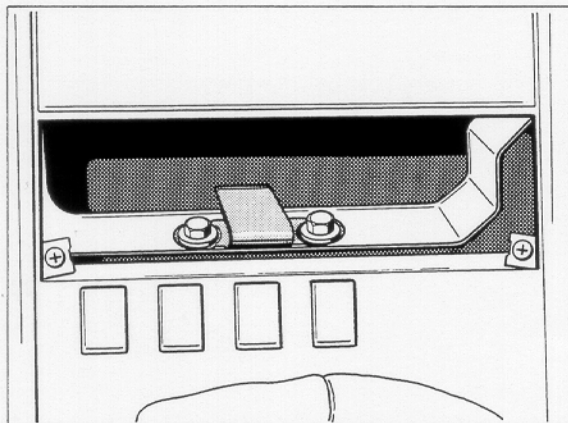

164 - 91

3. Fit trim panel to equalizer.
4. Connect equalizer (lines fitted in vehicle) and slide in.

Note

Connector assignment is specified on the equalizer.

5. Install retaining frame for CD player.

6. Connect CD player.

Note

The connector assignment is specified on the CD player.

7. Slide in CD player and latch.

REMOVING AND INSTALLING WINDSHIELD WIPERS SINCE 1985/2 MODELS

1. Loosen and pull off wiper arms. Pull off rubber seal with cover from above and loosen cement of cover below the windshield.

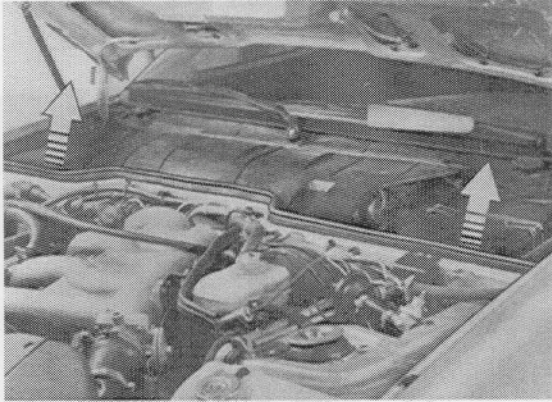

2. Disconnect plug.

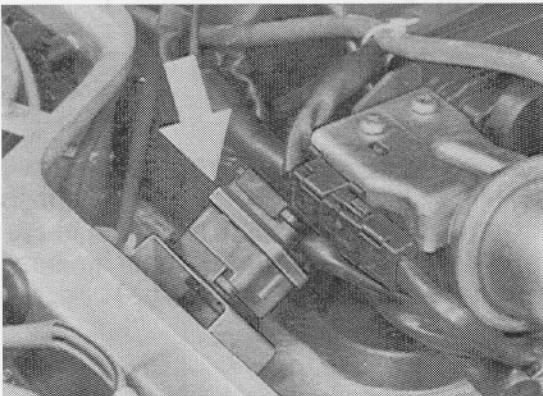

3. Unscrew and remove mounting screws of wiper assembly.

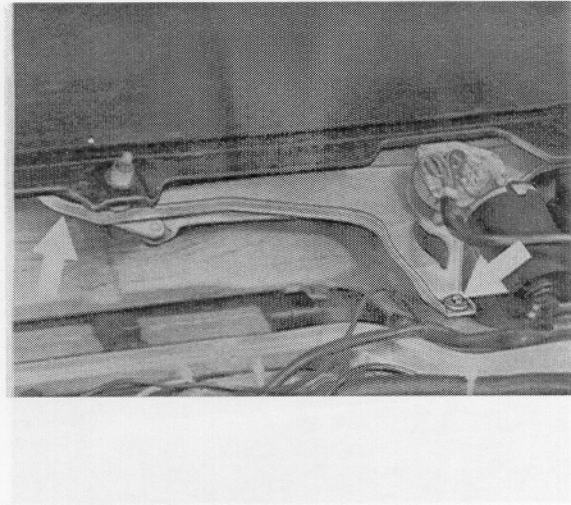

Tightening torque for
wiper arms = 15 Nm.

REMOVING AND INSTALLING ELECTRIC PUMP FOR WINDSHIELD WASHER SYSTEM

Removing

1. Disengage and pull out retaining clip.

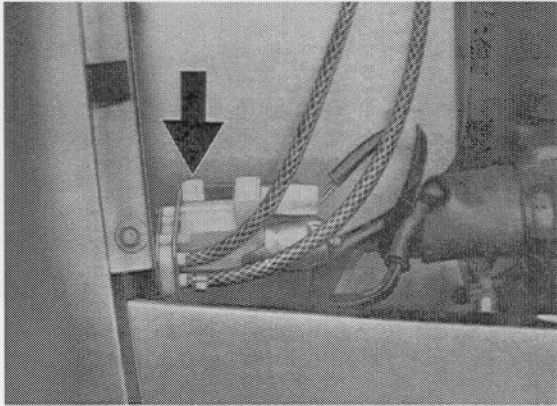

2. Push pump out of holder and remove.

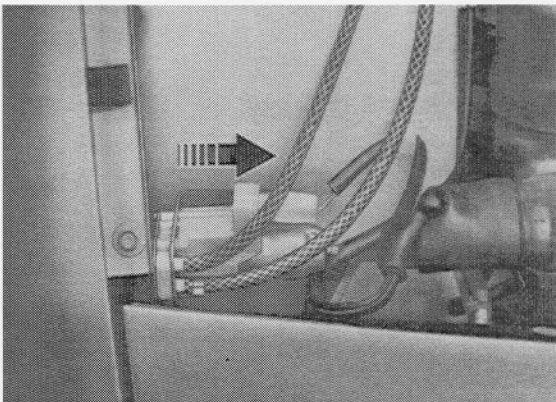

Note

The removal and installation of hose clamps is best done with special pliers, which are commercially available.

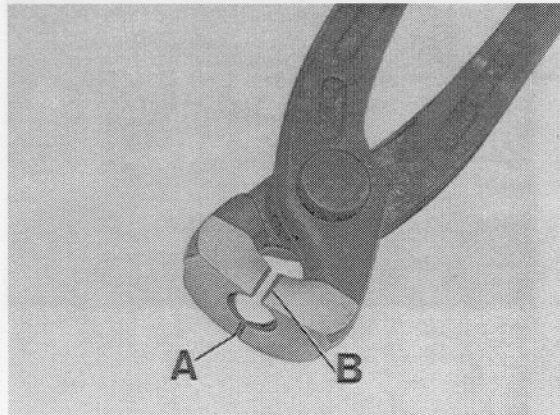

A - Edge for separating

B - Edge for clamping

When using normal cutting pliers, care must be taken to avoid subjecting the pump hose nipple to bending force when loosening the hose clamp (danger of breakage).

3. Transversely separate hose clamp on pump and pull off hoses. Disconnect plug connection.

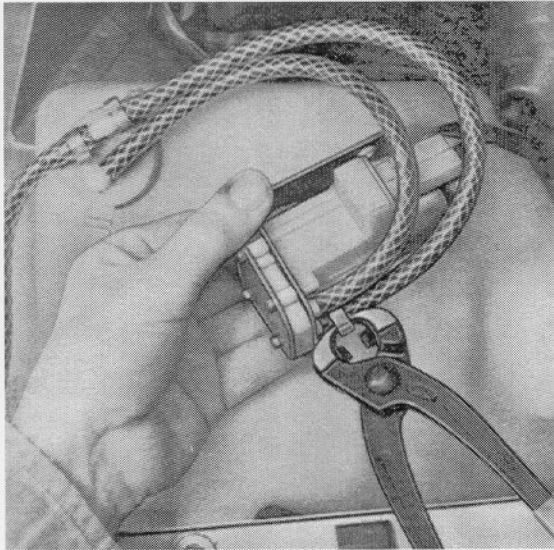

Installation

Install hose clamp and check for good seating.

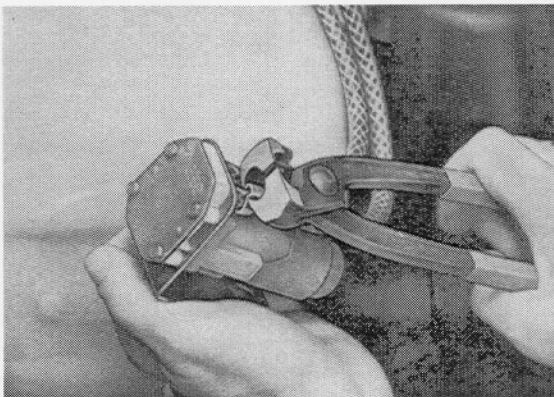

LUBRICATING LINKAGE OF CONCEALED HEADLIGHTS

Lubricate linkage of concealed headlights with a commercial multi-purpose grease when servicing car or after washing engine.

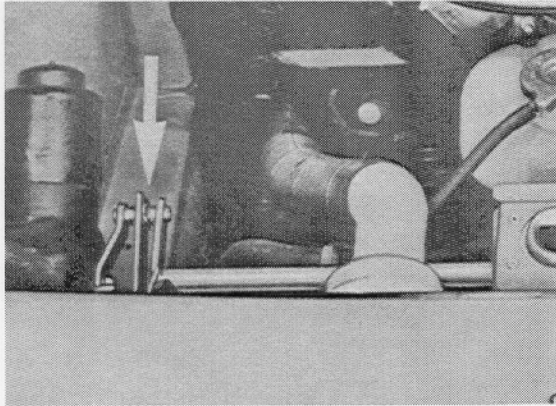

REMOVING AND INSTALLING SWITCH PLATES SINCE 1985/2 MODELS

1. Remove steering wheel. Unscrew trim on instrument panel at left side.

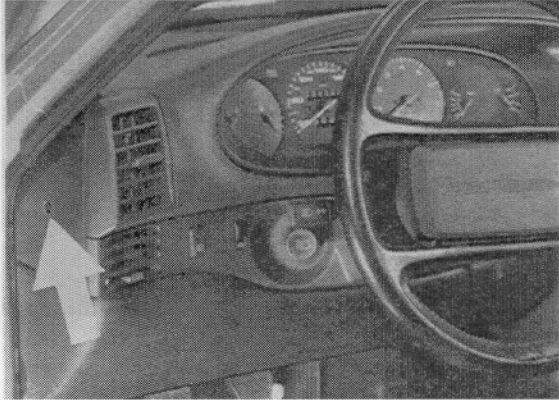

3. Unscrew switch plate mounting screws and remove. Pull off plug.

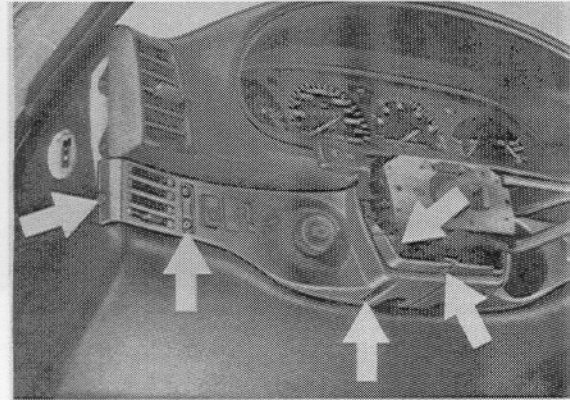

2. Loosen trim on steering column switch and remove cover mounting screws on switch plate.

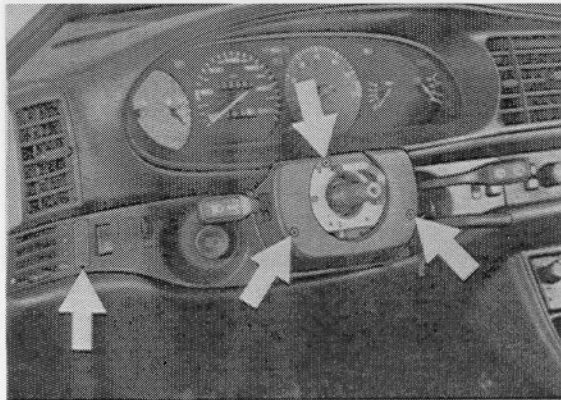

4. Pull off knobs on control switch. Pry off control switch plate carefully with help of a spatula.



5. Unscrew mounting screws of control switch and plate on steering lock.

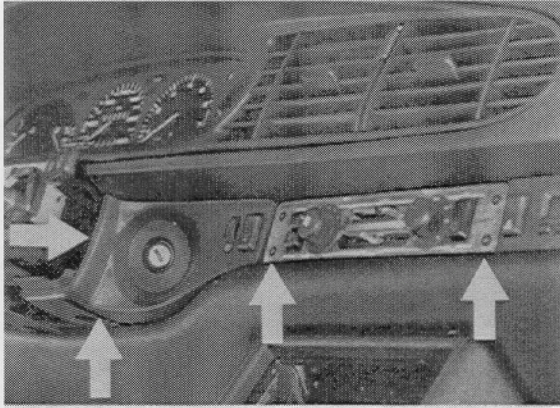

7. Turn escutcheon of inside sensor blower anticlockwise to disengage with a suitable item (e.g. coin).

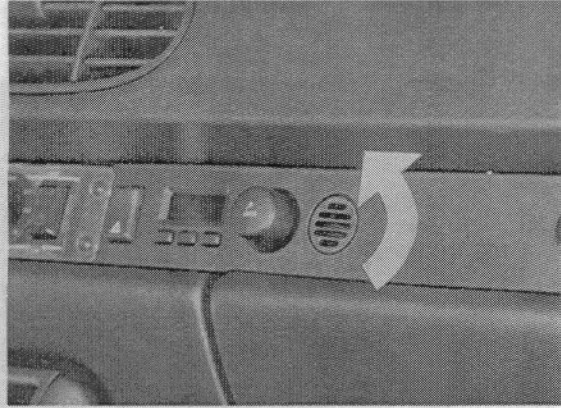

6. Loosen trim on right side of instrument panel and remove cover of mounting screws.

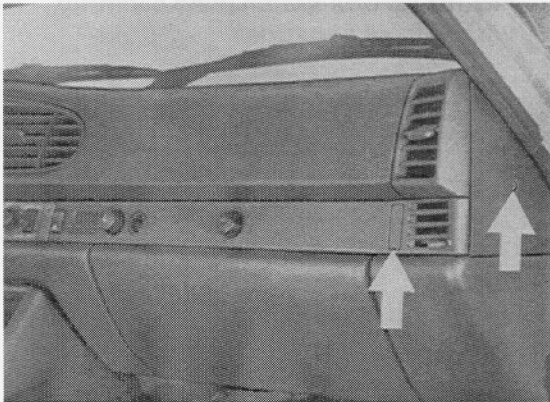

8. Unscrew mounting screws on right side of plate and take off plate.

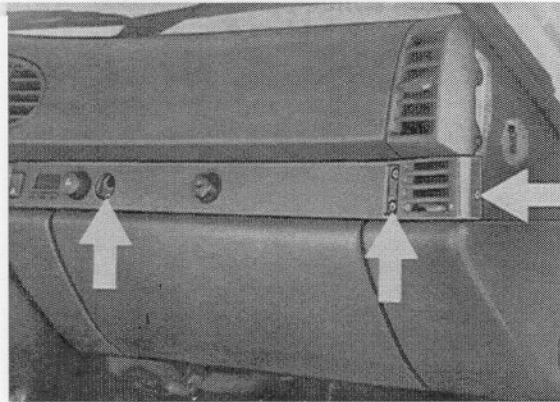

REMOVING AND INSTALLING LOCK
CYLINDER '85/2 MODELS ONWARD

1. Remove steering wheel (see page 48 - 17)

Note:

See Repair Group 68 for assembly work on cars fitted with airbags.

2. Remove steering-column switch trim.

3. Remove steering-column switch.

4. Disconnect plug from ignition/starter switch.

5. Drill out shear-head bolts in steering-lock housing.

6. Remove steering-lock housing.

7. Remove stud bolt from steering-lock housing.

Tightening torque: 0.25 Nm
(0.18 ftlb)

8. Drill holes in steering-lock housing with 3 mm drill as shown.

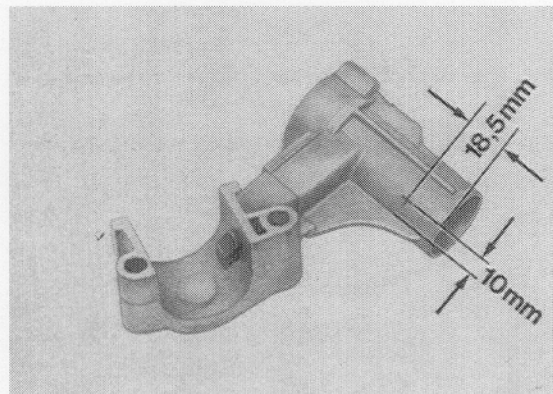

9. With the aid of a thumbtack or similar disengage lock cylinder and withdraw.

Note:

The lock cylinder engages automatically when it is pushed into the housing.

HEADLIGHT BEAM ADJUSTMENT, '88 MODELS ONWARD

The principle components of the system are the switch (potentiometer) and two actuators, one for each headlight, mounted on the headlight frames.

REMOVING AND INSTALLING ACTUATORS

1. Disconnect cable plug from actuator.
2. Unplug cable connector from headlight.
3. Remove headlight.
4. Disengage the actuator from the headlight frame with Special Tool 9287. Squeeze the detent lugs together by pushing Special Tool 9287 over the plastic part.

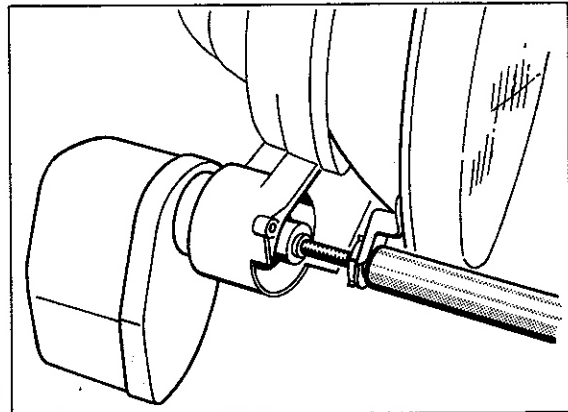

5. Turn actuator anticlockwise through approx. 60° and remove.

CHECKING HEADLIGHT BEAM ADJUSTMENT

1. Disconnect both plugs from actuators.
2. Switch on lights.
3. With a voltmeter, measure voltage between ter. 1 (+) and ter. 3 (-).

Reading: battery voltage

If no voltage is applied, check fuse 37 (944) or fuse 7 (924 S).

4. Connect voltmeter to ter. 1 (+) and ter. 2 (-).

Reading:

Switch in position 0: approx. 0 V

Switch in position 1: 2.0 - 2.7 V

Switch in position 2: 2.6 - 3.4 V

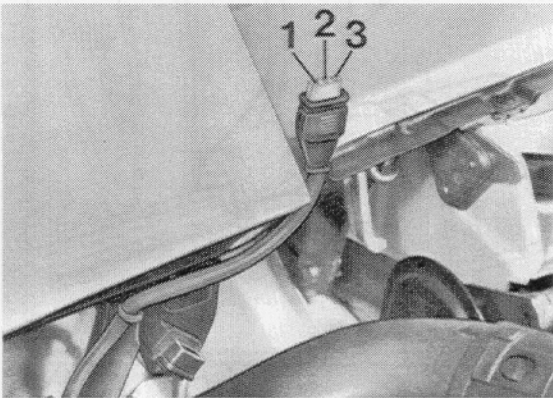

Note:

The battery-voltage reading taken in this test must be between 11 V and 13 V. If necessary, recharge battery.

AIMING MAIN HEADLIGHTS WITH HEADLIGHT BEAM ADJUSTMENT

The main headlights are aimed with the switch in position 0.

1. Switch on lights

2. Use a headlight aiming device to adjust headlights with car ready for the road: fuel tank full, driver's seat occupied by 1 person or a weight of 75 kg. The tire pressures must be as specified.

In position 0, beams lowered by:

10 cm in 10 m

In position 1, beams lowered by:

22 cm \pm 1 cm in 10 m

In position 2, beams lowered by:

25 cm \pm 1 cm in 10 m

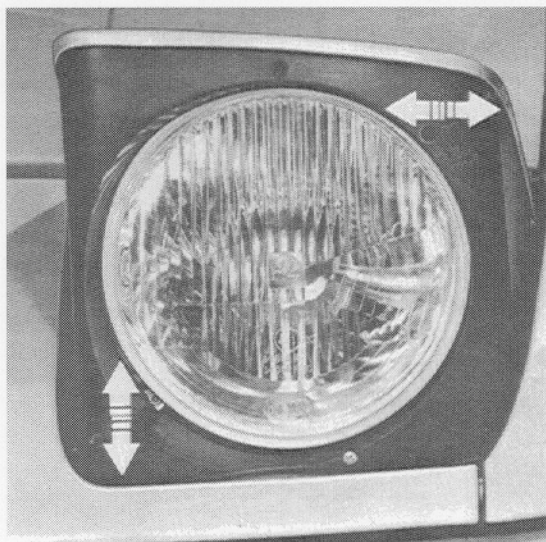

Position of switch for headlight beam adjustment with reference to vehicle load.

Position 0

1 - 2 occupants without luggage

Position 1

3 - 4 occupants without luggage

Position 2

1 - 4 occupants with luggage

REMOVING AND INSTALLING CENTRAL ELECTRIC SINCE 1985/2 MODELS

1. Disconnect battery.
2. Take off central electric cover.
3. Unscrew mounting screws of central electric board.
4. Remove central electric from above and unscrew power supply.
5. Pull out (unlock) the central locking rail.

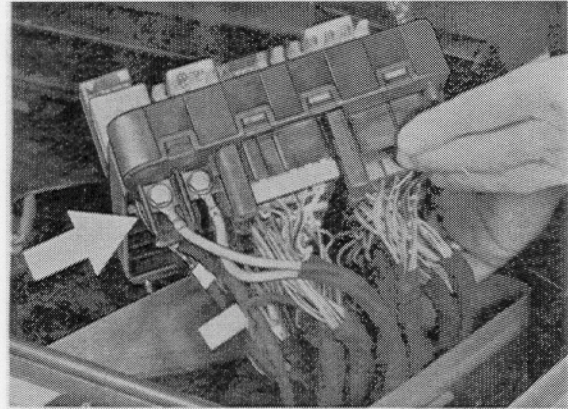
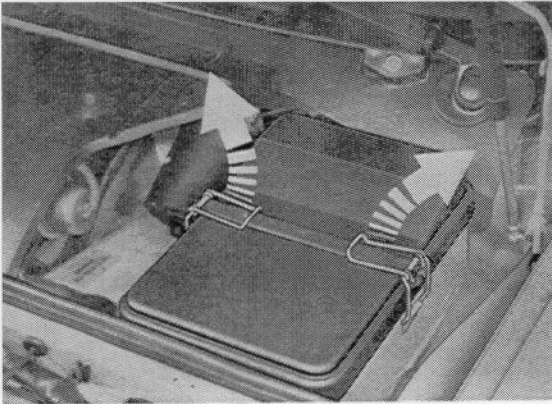

3. Unscrew mounting screws of central electric board.

5. Pull out (unlock) the central locking rail.

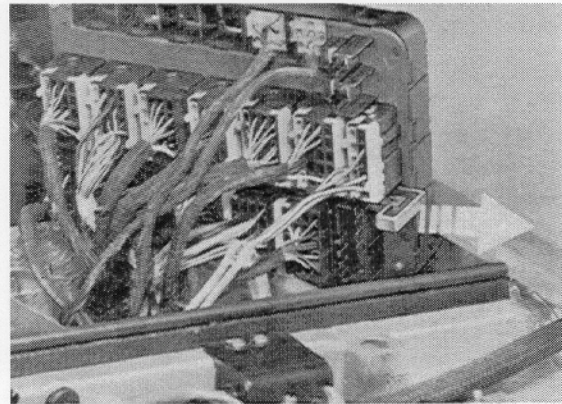
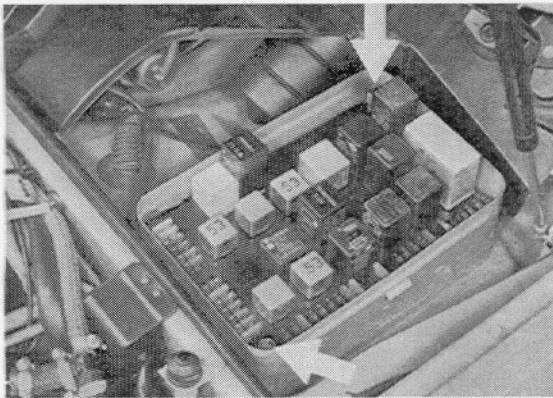

6. Pull off multiple-pin plug, but do not pull on wires. Plug receptacles are marked with letters. There are also coding grooves on the sides of plug receptacles so that wrong connections are excluded.

7. Unlock the additional relay socket by pressing in a narrow spatula (about 10 to 12 mm wide) or similar tool from the side up to the catch.

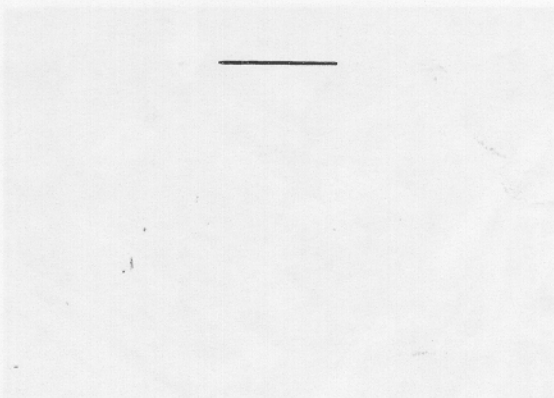
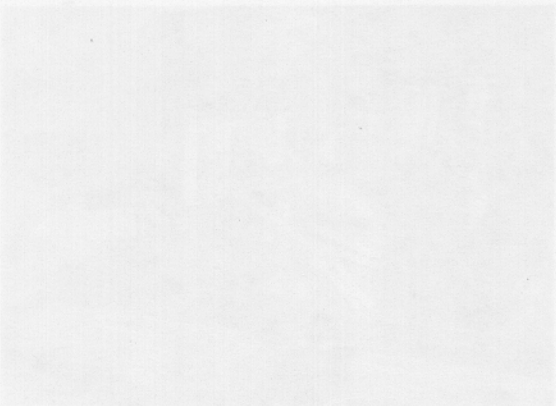
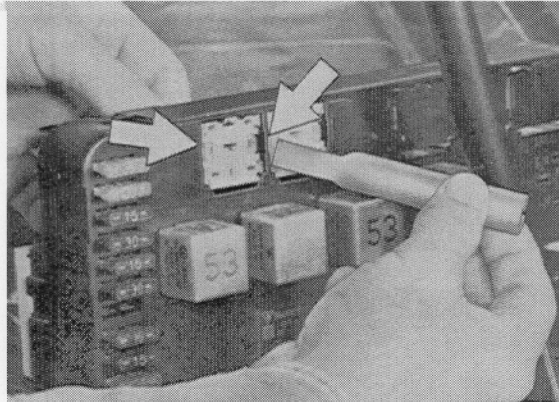
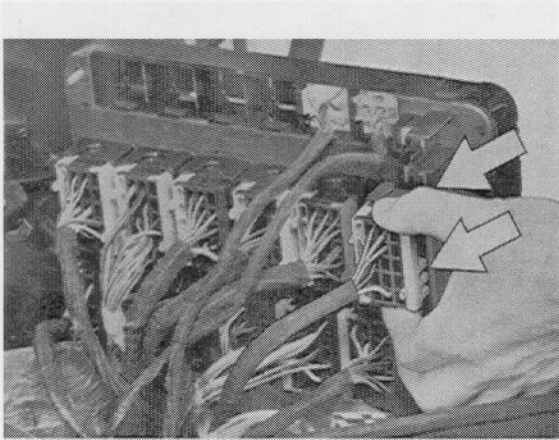

CENTRAL ELECTRICS UNIT, ASSIGNMENT

The assignment data for the central electrics unit with additional plug-on relays are stated incorrectly in the 944, 944 turbo, 944 S wiring diagram, '87 models, sheet 10, page 97 - 117. The correct assignments are:

- G 17 - Air conditioner relay
 - G 18 - Unoccupied
 - G 19 - Unoccupied
 - G 20 - ABS relay
 - G 21 - Tilting-roof relay
 - G 22 - Turbocharger pump relay
-

MODIFYING WIRE HARNESS

When replacing the passenger-compartment wire harness in '85/2 models up to vehicle identification numbers.

94 FN 40 1638 - 944 R.O.W.

94 FN 45 1912 - 944 USA,

95 FN 10 0122 - 944 turbo R.O.W.

95 FN 15 0106 - 944 turbo USA

the harness must be modified prior to installation as follows:

1. Disconnect red/green 1.5 mm² wire from plug L 4.1 and insert in K 3.2.

2. Remove bridge between F 3.4 and K 2.5 (yellow/red wire 1.0 mm²).

3. Disconnect yellow/blue 1.0 mm² wire from plug F 3.3 and insert in K 2.5.

4. Disconnect red 1.5 mm² wire from plug L 4.2 and insert in K 3.1.

5. Disconnect green 0.5 mm² wire from plug F 1.4 and insert in B 1.1.

6. Disconnect red/green 1.0 mm² wire from plug J 2.4 and insert in F 1.4.

Similarly, replacement nose-section wire harnesses must also be modified as follows:

1. Disconnect red/green 1.0 mm² wire from plug H 2.3.

2. Disconnect black/yellow 1.0 mm² wire from plug E 4.4.

3. Insert red/green wire in plug E 4.4.

4. Insert black/yellow wire in plug H.2.3

Supplementary electrical equipment

Important

Supplementary electrical equipment may only be connected using the possible connections described below.

Term. 30, not fused:

1. Screw connections on line to central electrical system
2. Plug A 11

Term. X, not fused:

Plug A 14

Term. 15, not fused:

Plug A 22

Term. 31:

1. Plug A 23
2. Grounding point II
3. Grounding point III

Fusing

Important

Supplementary electrical equipment must be fused if the above connection points are used.

1. Fuse 35: Ingoing plug F 23
Outgoing plug D 21 und E 21
2. Separate fuses

Current Flow Diagram Type 944 USA Model 83

PART I	POWER SUPPLY, STARTER DIGITAL MOTOR ELECTRONIC (DME) FUEL PUMP
PART II	LIGHT SWITCH, CONCEALING HEADLIGHT FOG LIGHTS HEADLIGHT PARKING LIGHT, REAR LIGHT
PART III	BRAKE LIGHT EMERGENCY FLASHER TURN SIGNAL, BACK-UP LIGHT HORN INTERIOR LIGHT
PART IV	REAR WINDOW DEFOGGER, IGNITION/STARTER SWITCH, SEAT BELTS INSTRUMENT CLUSTER
PART V	INSTRUMENTS CENTER CONSOLE WIND SHIELD WIPER
PART VI	FRESH AIR BLOWER COOLING FAN

Current Flow Diagram Type 944 USA Model 83

WIRE CONNECTORS

T1 - ONE-POLE

- A - NEAR FUSE/RELAY BOARD
- B - IN ENGINE COMPARTMENT
- C - NEAR BRAKE BOOSTER
- D - IN INSTRUMENT PANEL
- E - ON REAR LID
- H - NEAR DOOR SWITCH, RIGHT
- I - NEAR RADIO

T2 - TWO-POLE

- A - NEAR FRESH AIR BLOWER
- B - IN INSTRUMENT PANEL
- C - NEAR LEFT SEAT
- D - NEAR RIGHT REAR LIGHTS
- E - NEAR LEFT REAR LIGHTS
- F - NEAR FUSE/RELAY BOARD
- G - NEAR FUSE/RELAY BOARD
- H - NEAR LEFT HEAD LIGHTS
- I - NEAR RIGHT HEAD LIGHTS
- K - CENTER CONSOLE LEFT
- L - IN ENGINE COMPARTMENT
- M - NEAR FOG LIGHT, LEFT
- N - NEAR FOG LIGHT, RIGHT
- O - IN ENGINE COMPARTMENT

T3 - THREE-POLE

- B - NEAR HEADLIGHT, LEFT
- C - NEAR HEADLIGHT, RIGHT

T4 - FOUR-POLE

- NEAR FUSE/RELAY BOARD

T6 - SIX-POLE

- A - NEAR FUSE/RELAY BOARD
- B - IN CENTER CONSOLE

T7 - SEVEN-POLE

- B - NEAR RIGHT REAR LIGHTS
- C - NEAR LEFT REAR LIGHTS

T9 - NINE-POLE

- IN ENGINE COMPARTMENT

GROUND TERMINALS

- ① NEAR FUSE/RELAY BOARD
- ② IN LUGGAGE COMPARTMENT, NEAR LEFT REAR LIGHT
- ③ NEAR DISTRIBUTOR
- ④ NEAR LEFT HEADLIGHT
- ⑤ NEAR RIGHT HEADLIGHT

WIRE COLOURS

- | | | |
|------------|-------------|-------------|
| BK - BLACK | GN - GREEN | BR - BROWN |
| WT - WHITE | YE - YELLOW | BL - BLUE |
| RE - RED | GR - GREY | VI - VIOLET |

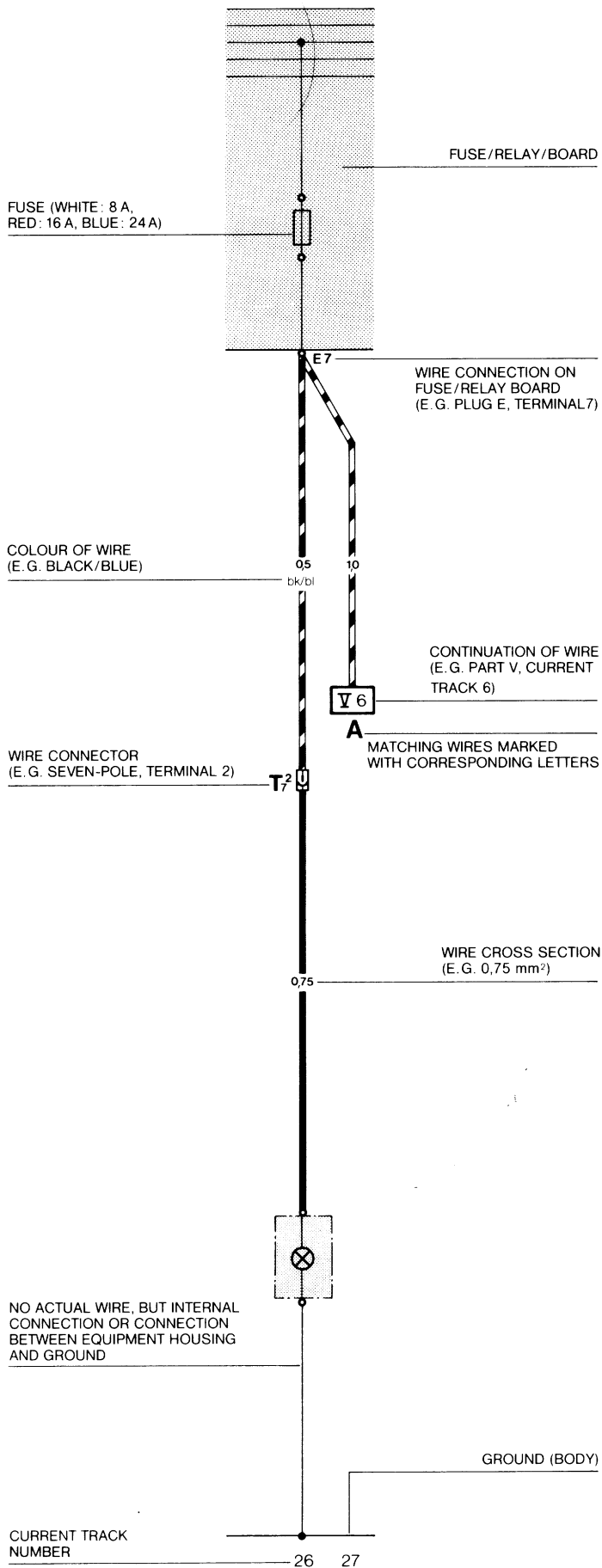

Current Flow Diagram Type 944 USA Model 83 Part I

POWER SUPPLY, STARTER
DIGITAL MOTOR ELECTRONIC (DME)
FUEL PUMP

Current Flow Diagram Type 944 USA Model 83

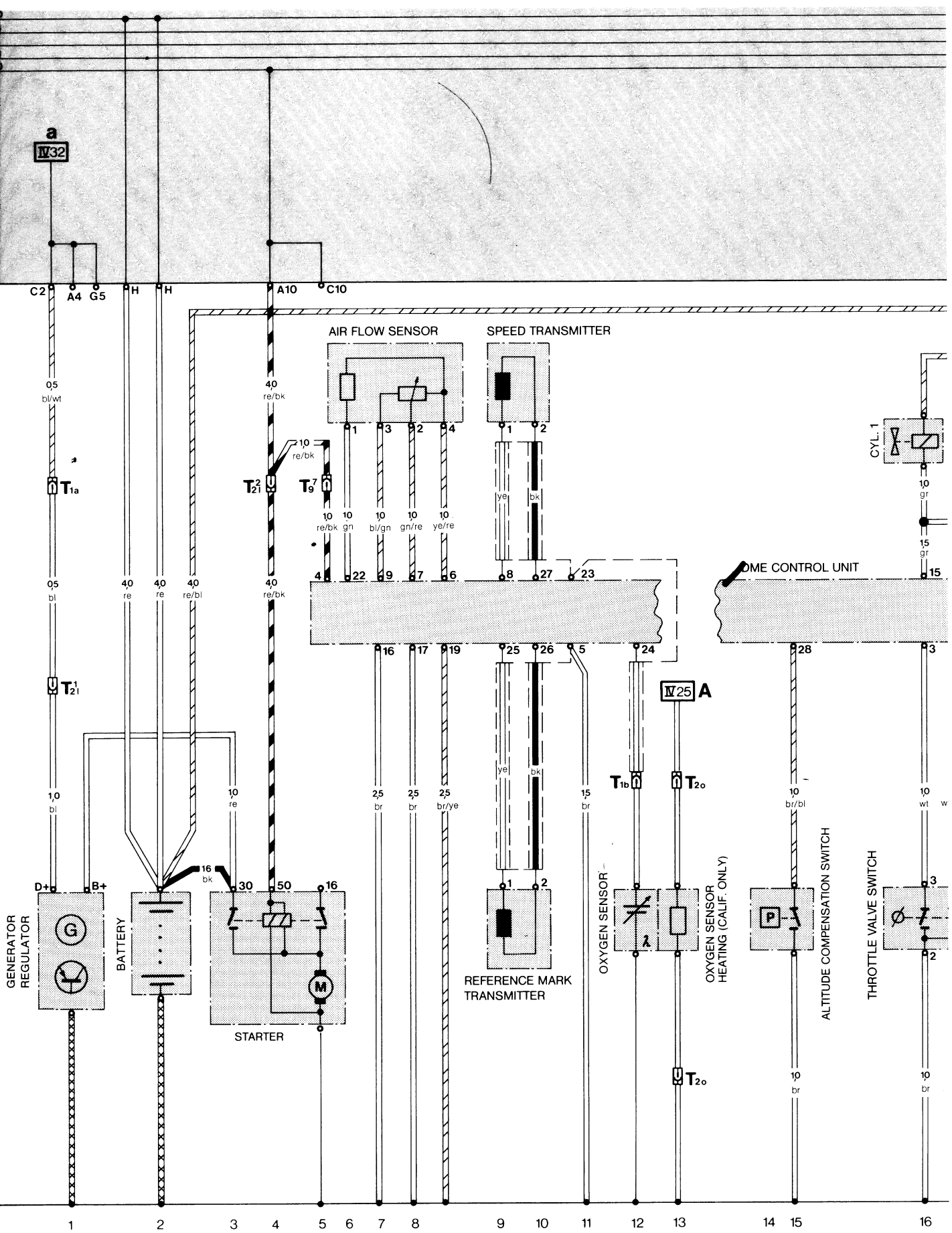

POWER SUPPLY, STARTER

DIGITAL MOTOR ELECTRONICS

30
15
X
31
50

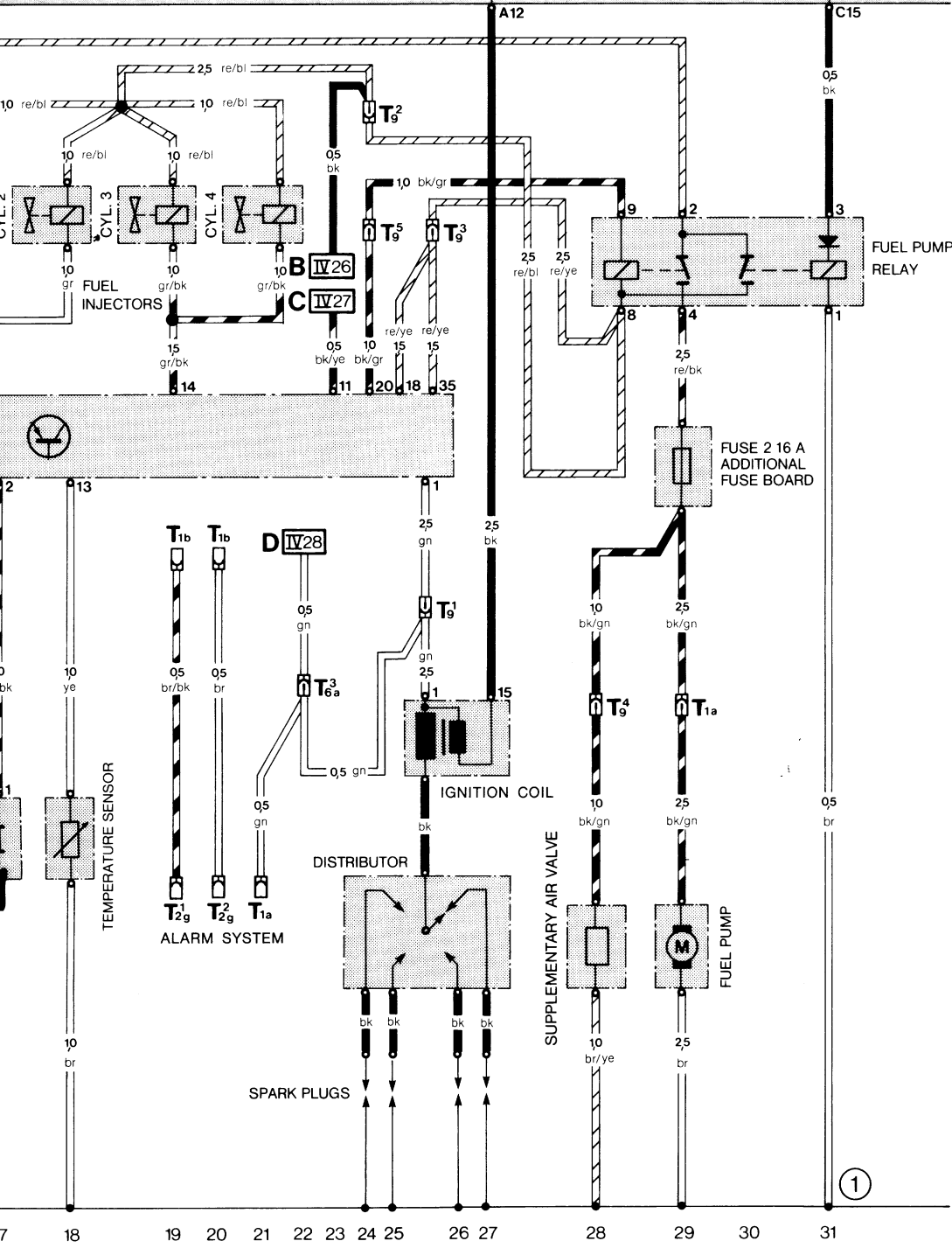

C (DME) ————— FUEL PUMP —————

Current Flow Diagram Type 944 USA Model 83 Part II

LIGHT SWITCH, CONCEALING HEADLIGHT

FOG LIGHTS

HEADLIGHT

PARKING LIGHT, REAR LIGHT

Current Flow Diagram Type 944 USA Model 83 Pa

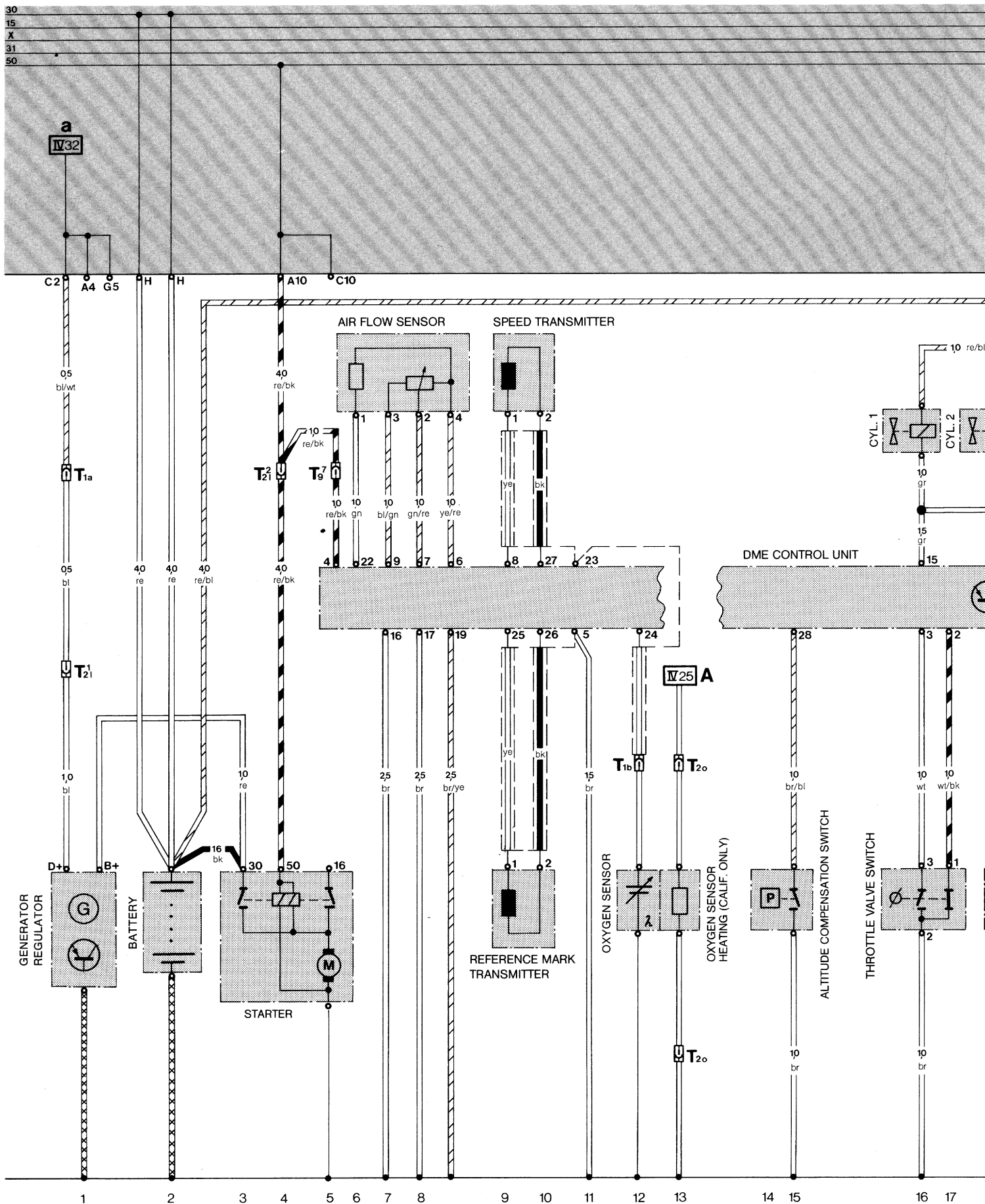

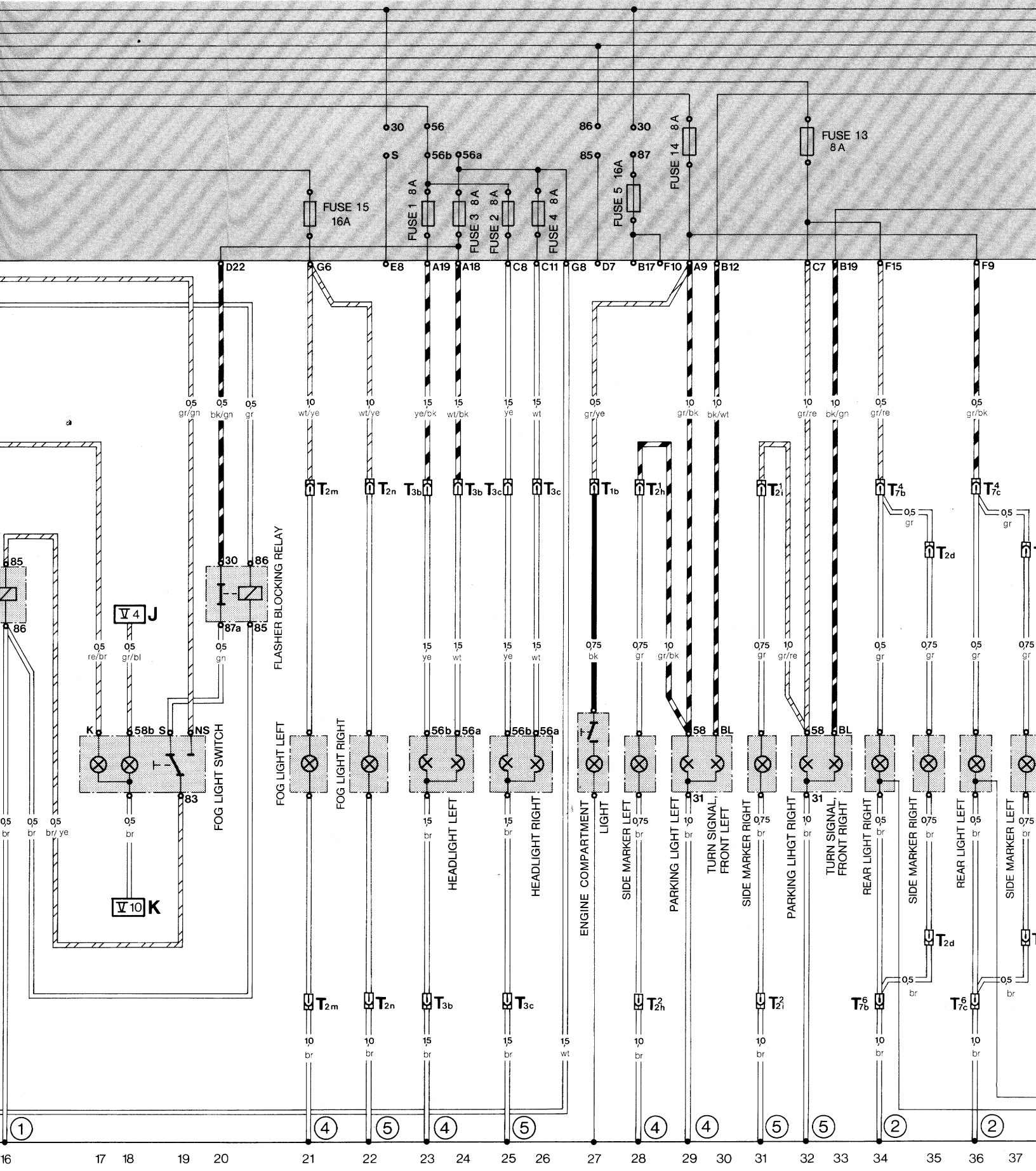

FOG LIGHTS HEADLIGHT PARKING LIGHT, REAR LIGHT

Current Flow Diagram Type 944 USA Model 83 Part III

BRAKE LIGHT
EMERGENCY FLASHER
TURN SIGNAL, BACK-UP LIGHT
HORN
INTERIOR LIGHT

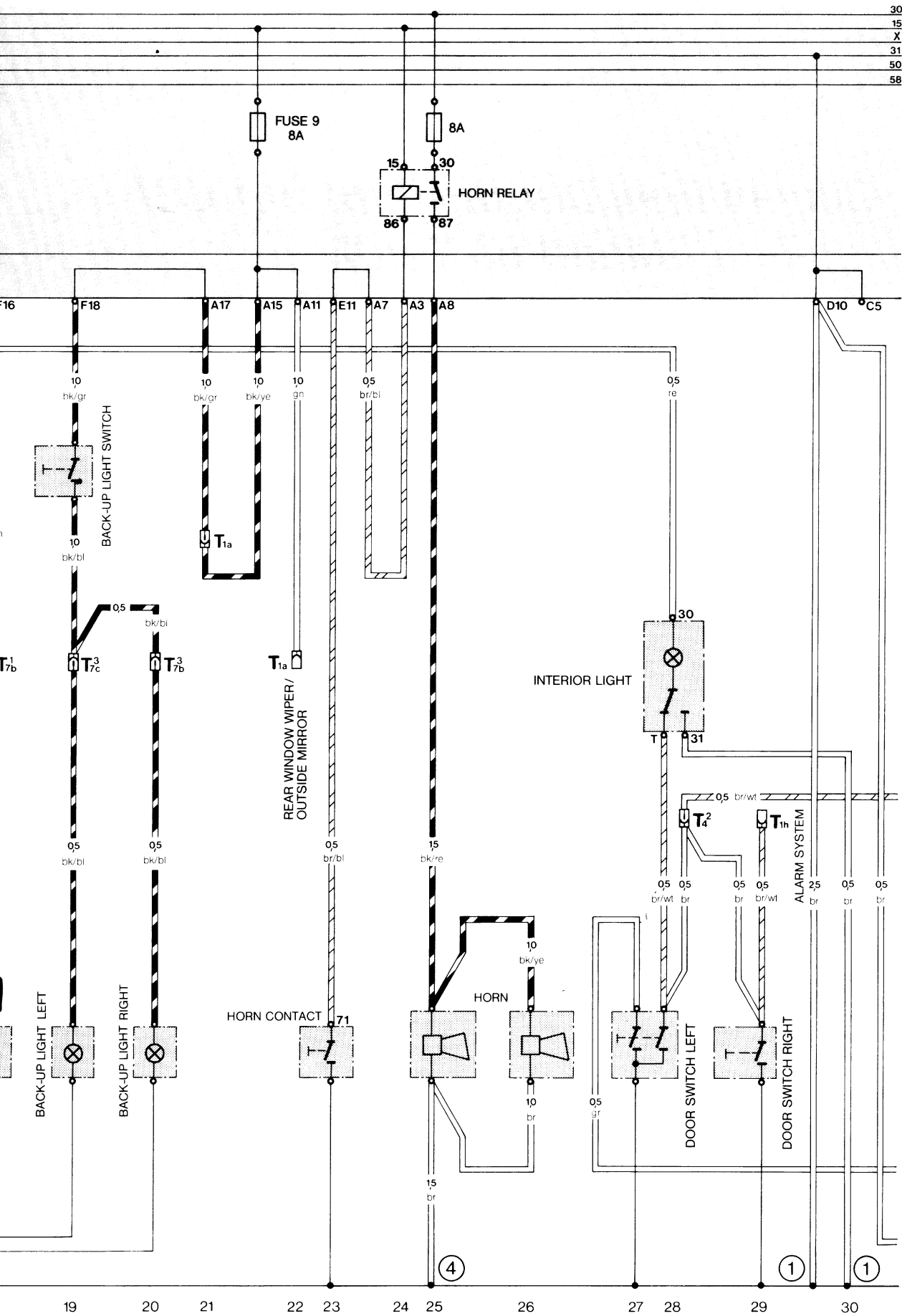

SIGNAL, BACK-UP LIGHT | HORN | INTERIOR LIGHT

Current Flow Diagram Type 944 USA Model 83

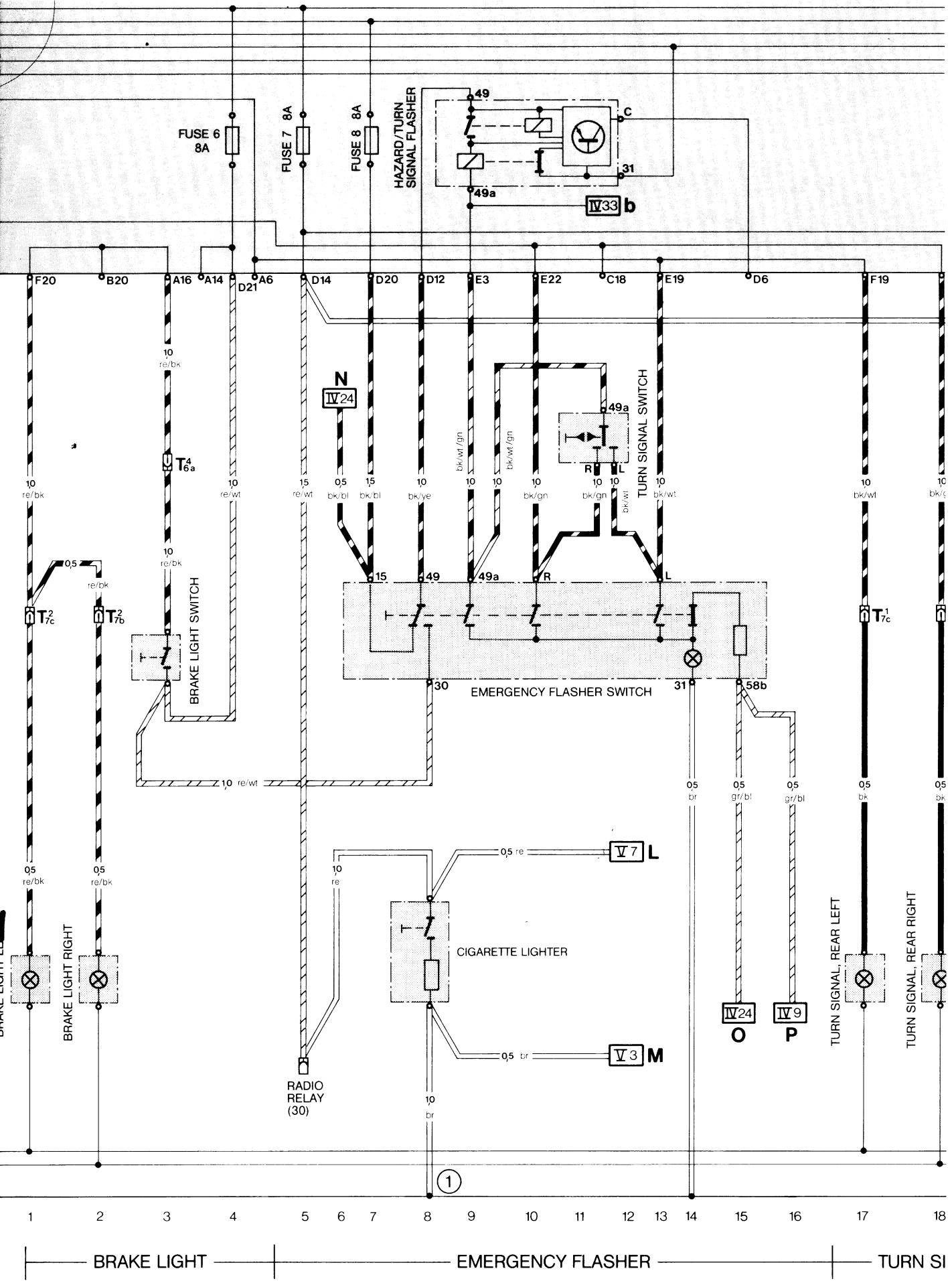

Current Flow Diagram Type 944 USA Model 83 Part IV

REAR WINDOW DEFOGGER,
IGNITION/STARTER SWITCH, SEAT BELTS
INSTRUMENT CLUSTER

Current Flow Diagram Type 944 USA Model 83 Part

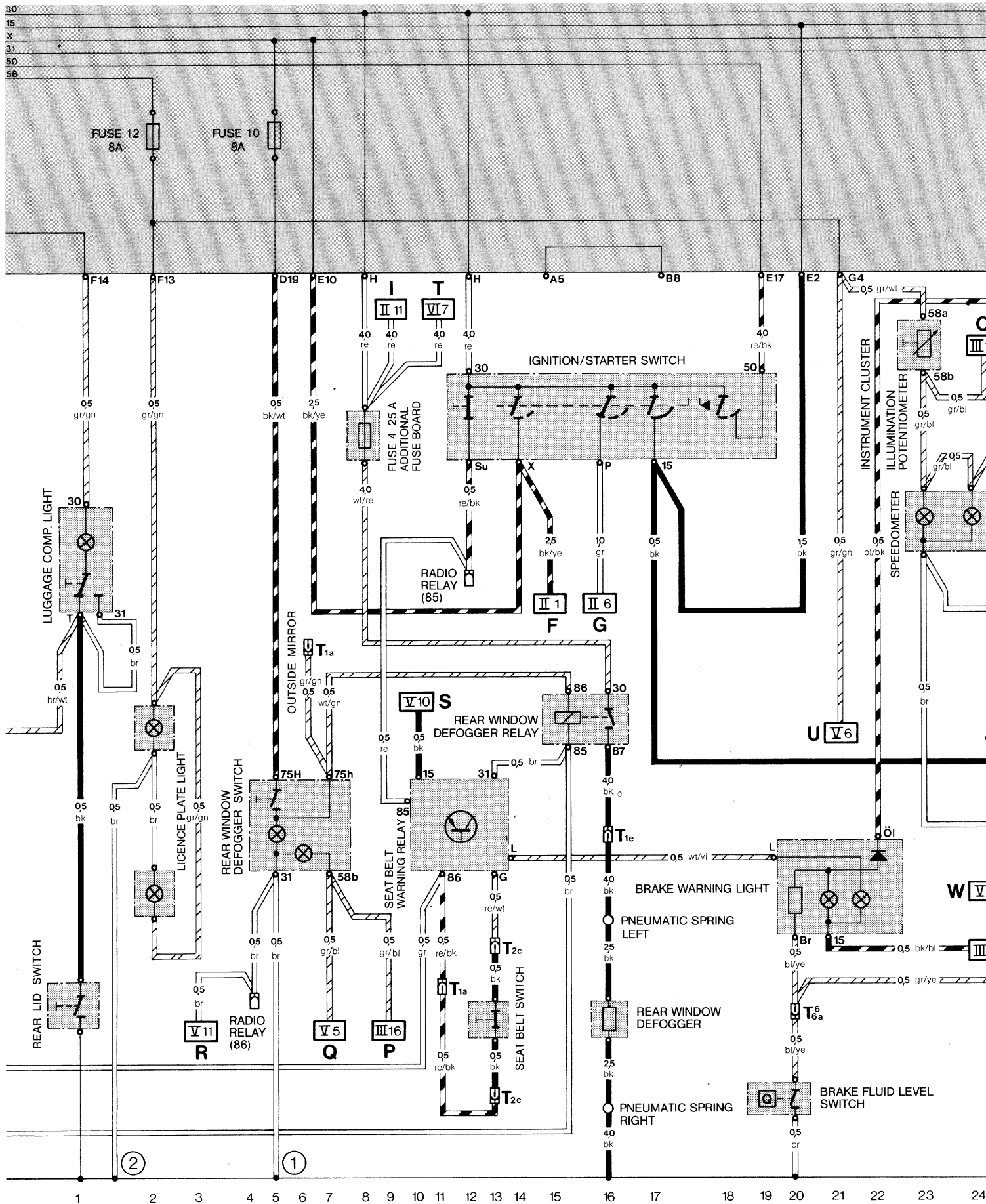

REAR WINDOW DEFOGGER, IGNITION/STARTER SWITCH, SEAT BELTS -

30
15
X
31

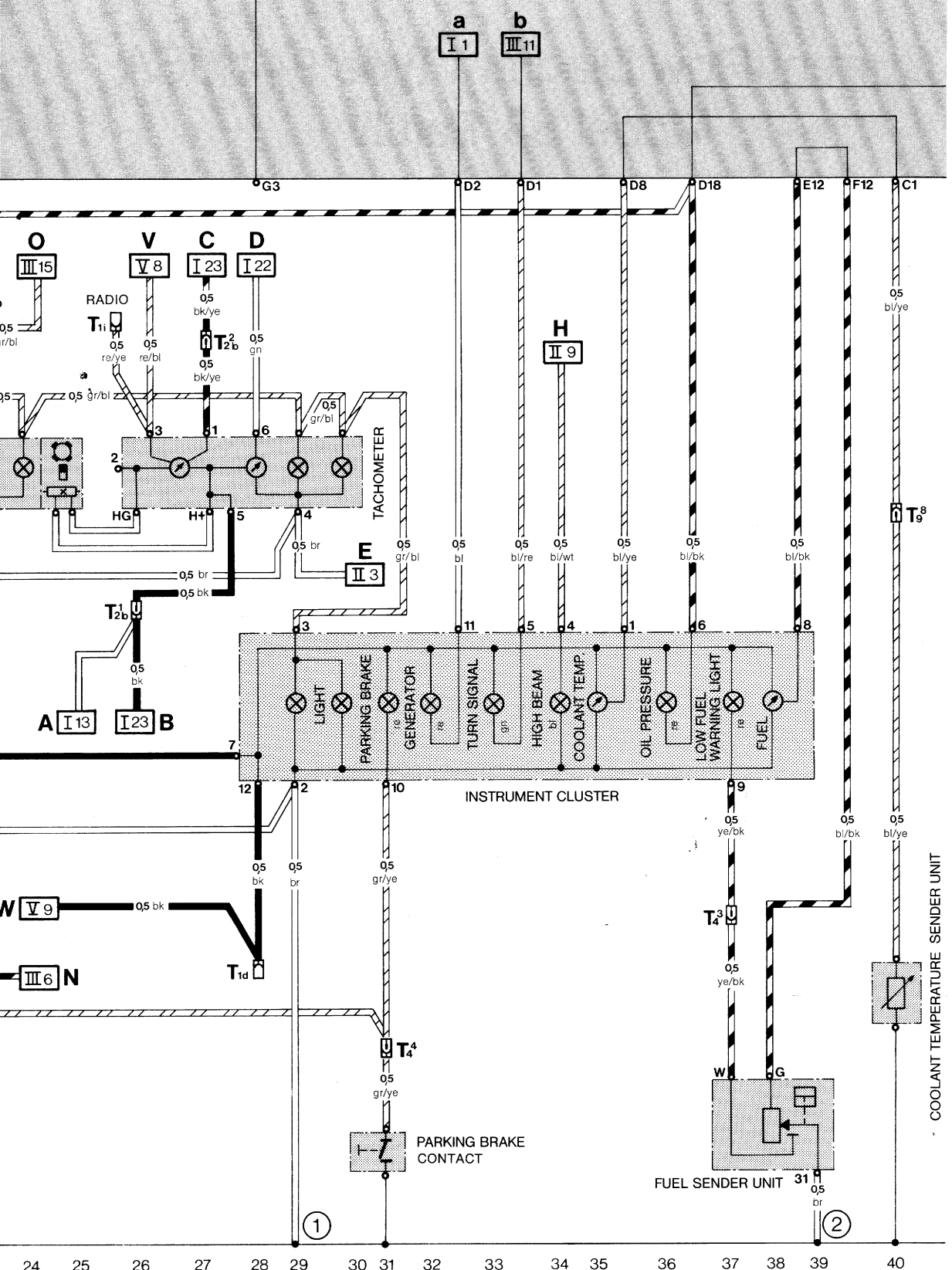

TS ————— INSTRUMENT CLUSTER —————

Current Flow Diagram Type 944 USA Model 83 Part V

INSTRUMENTS CENTER CONSOLE
WIND SHIELD WIPER

Current Flow Diagram Type 944 USA Model 83 Part

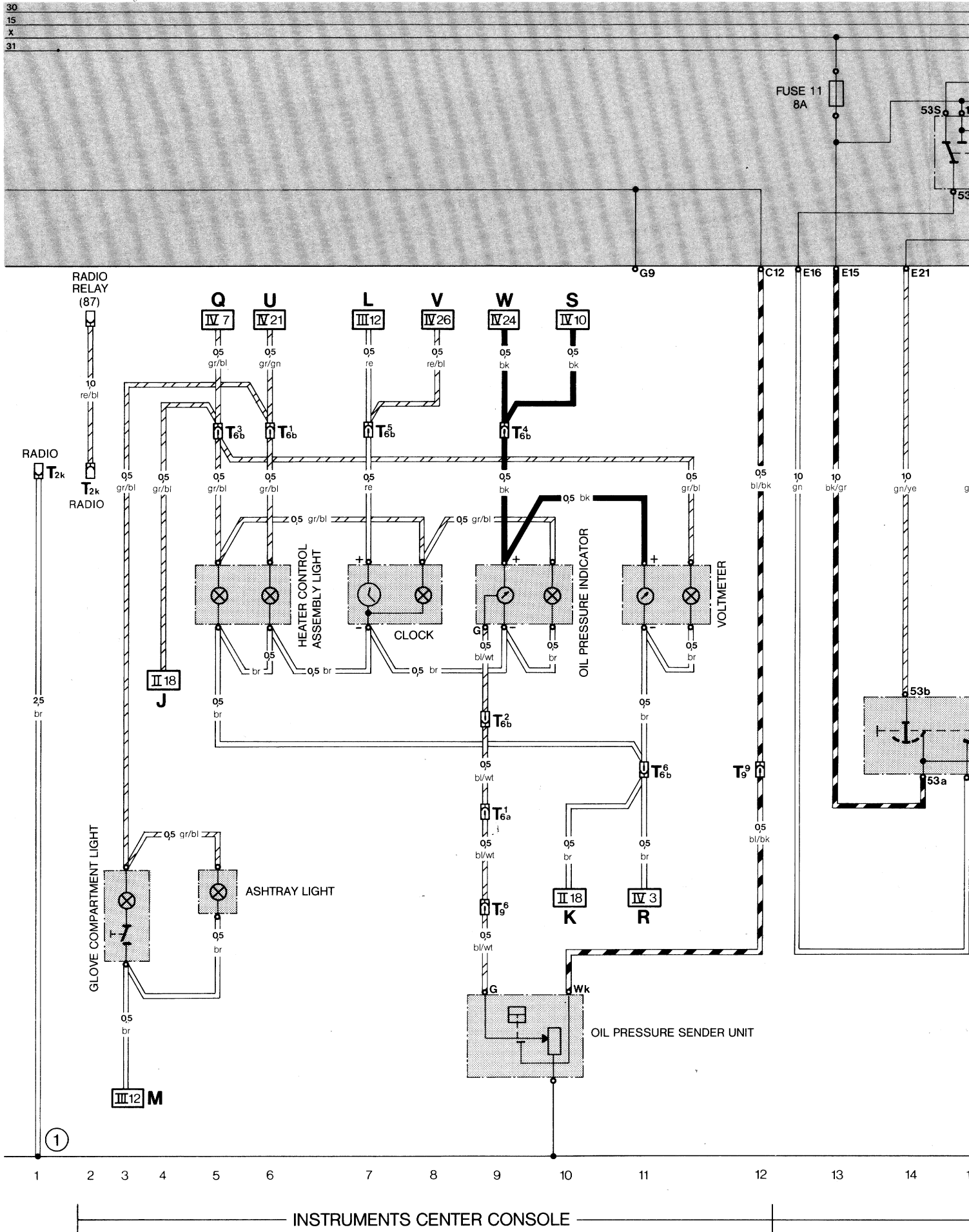

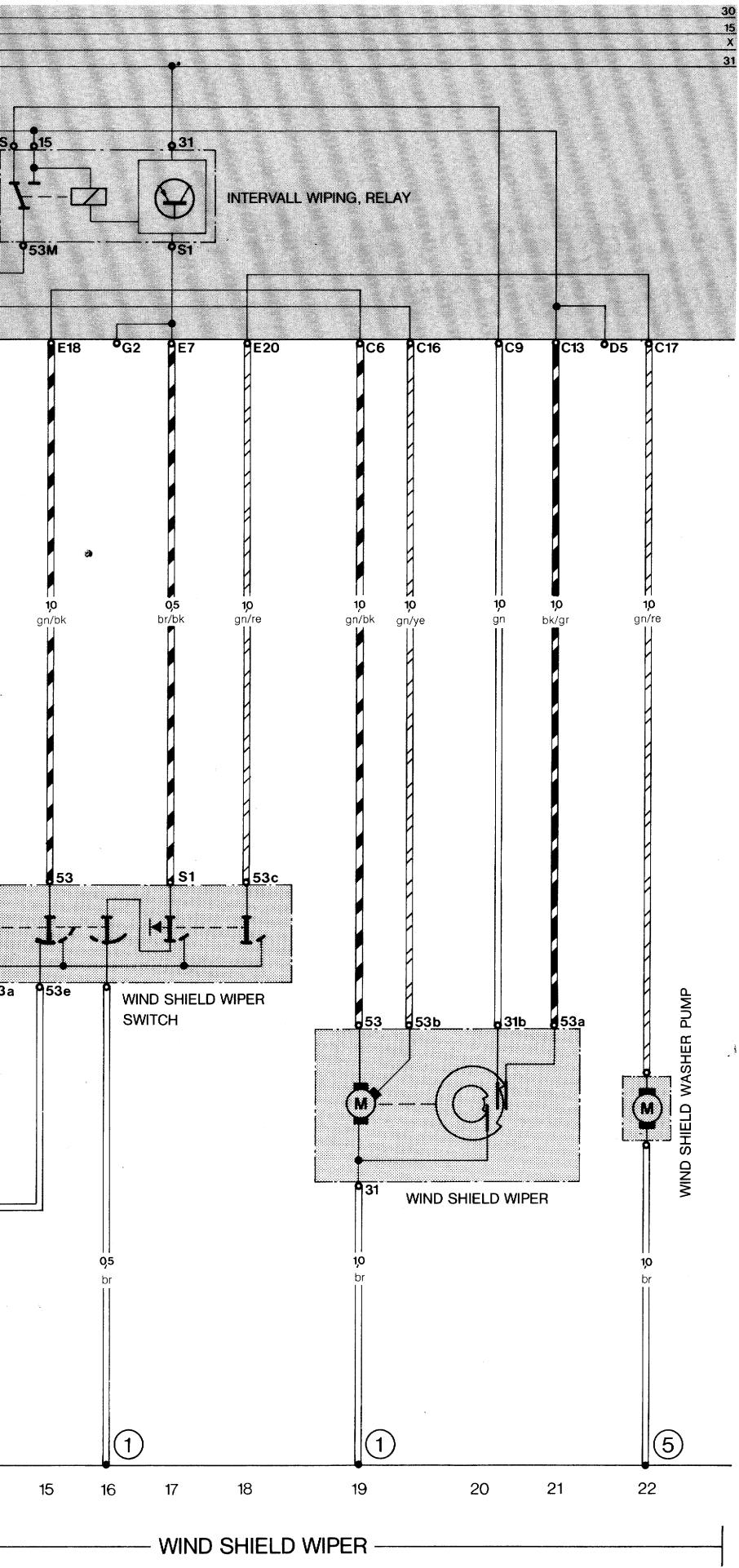

Current Flow Diagram

Type 944 USA Model 83 Part VI

97
Wiring

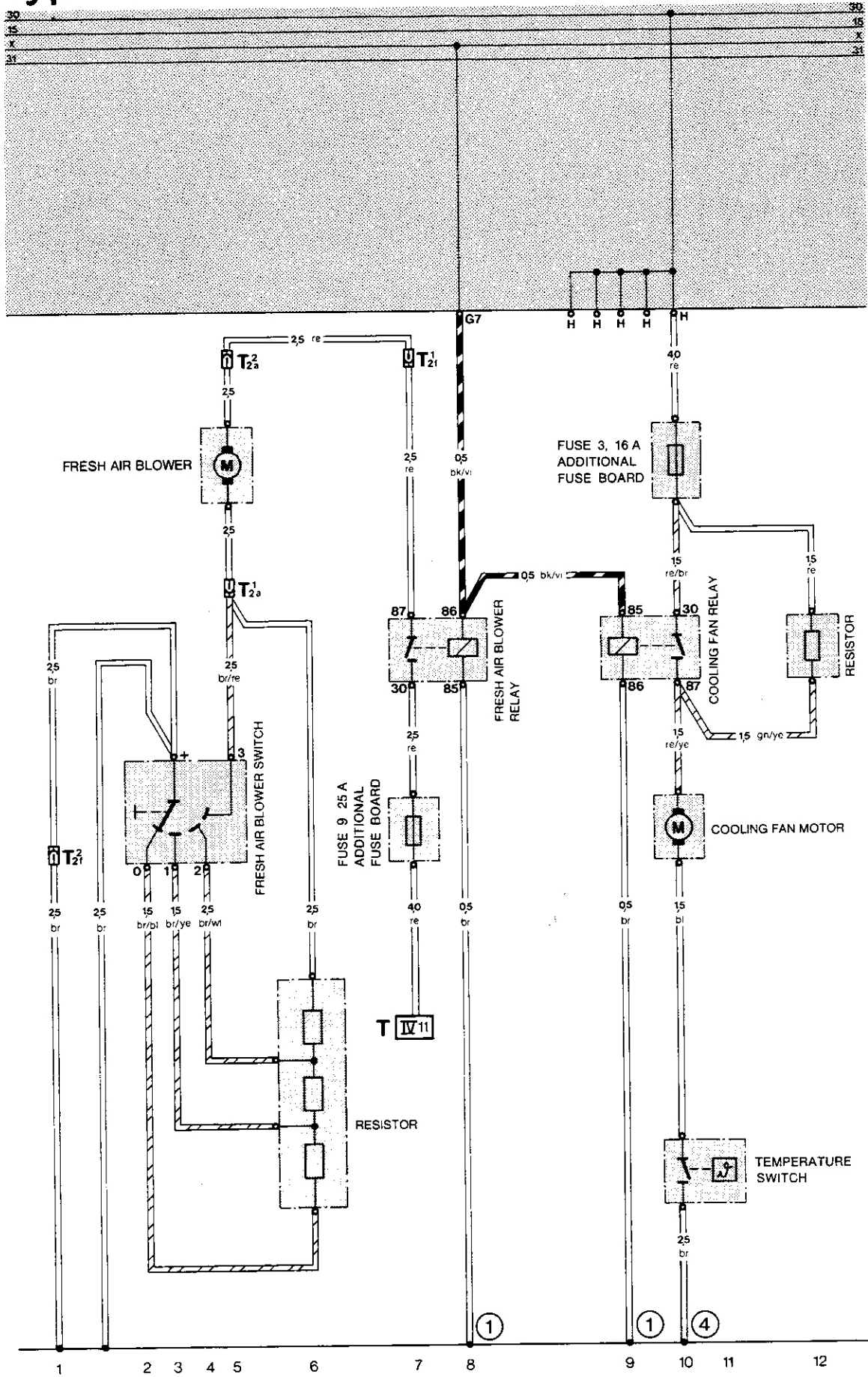

FRESH AIR BLOWER COOLING FAN

Additional Current Flow Diagram Type 944 USA

AIR CONDITIONER

Additional Current Flow Diagram Type 944 USA A

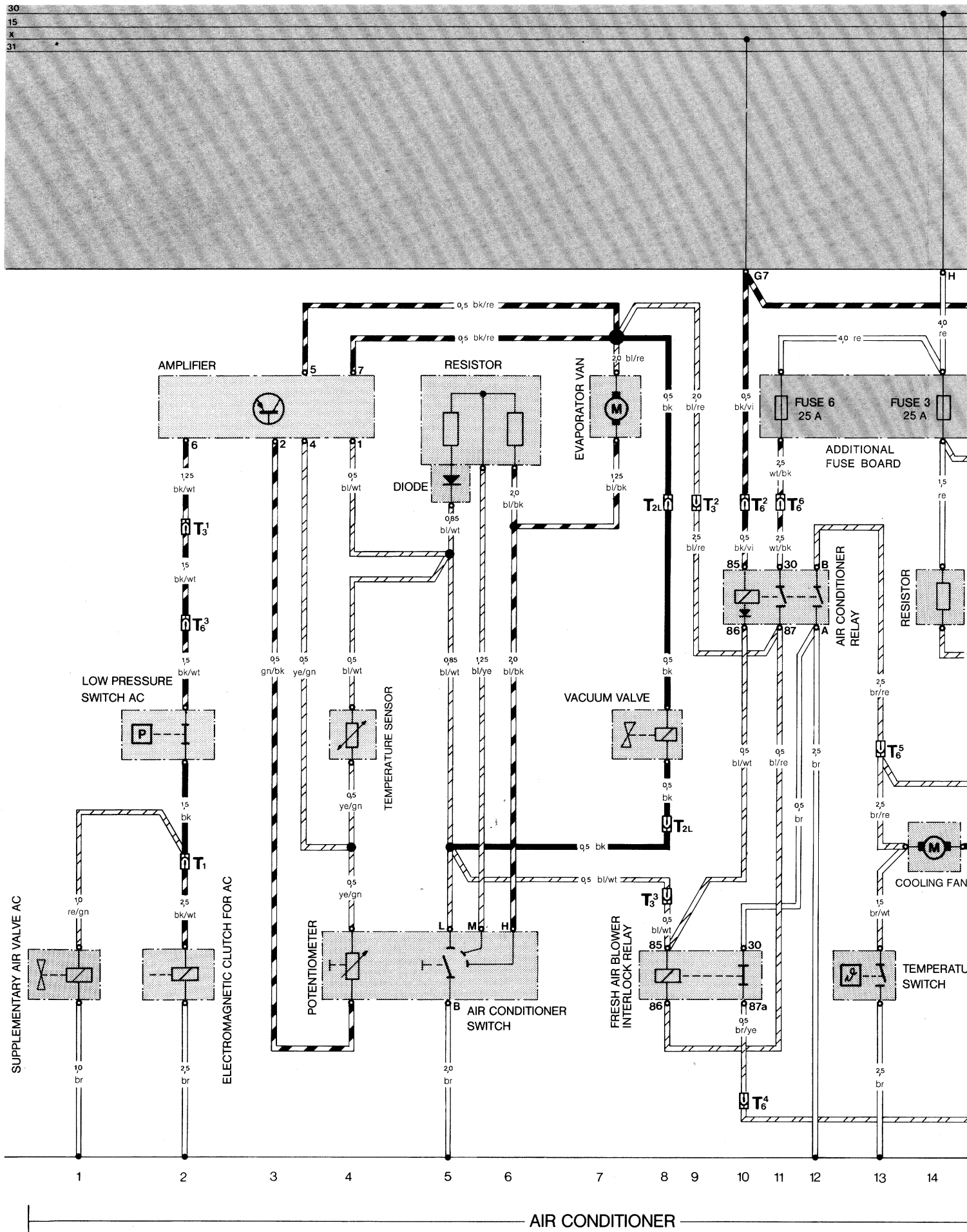

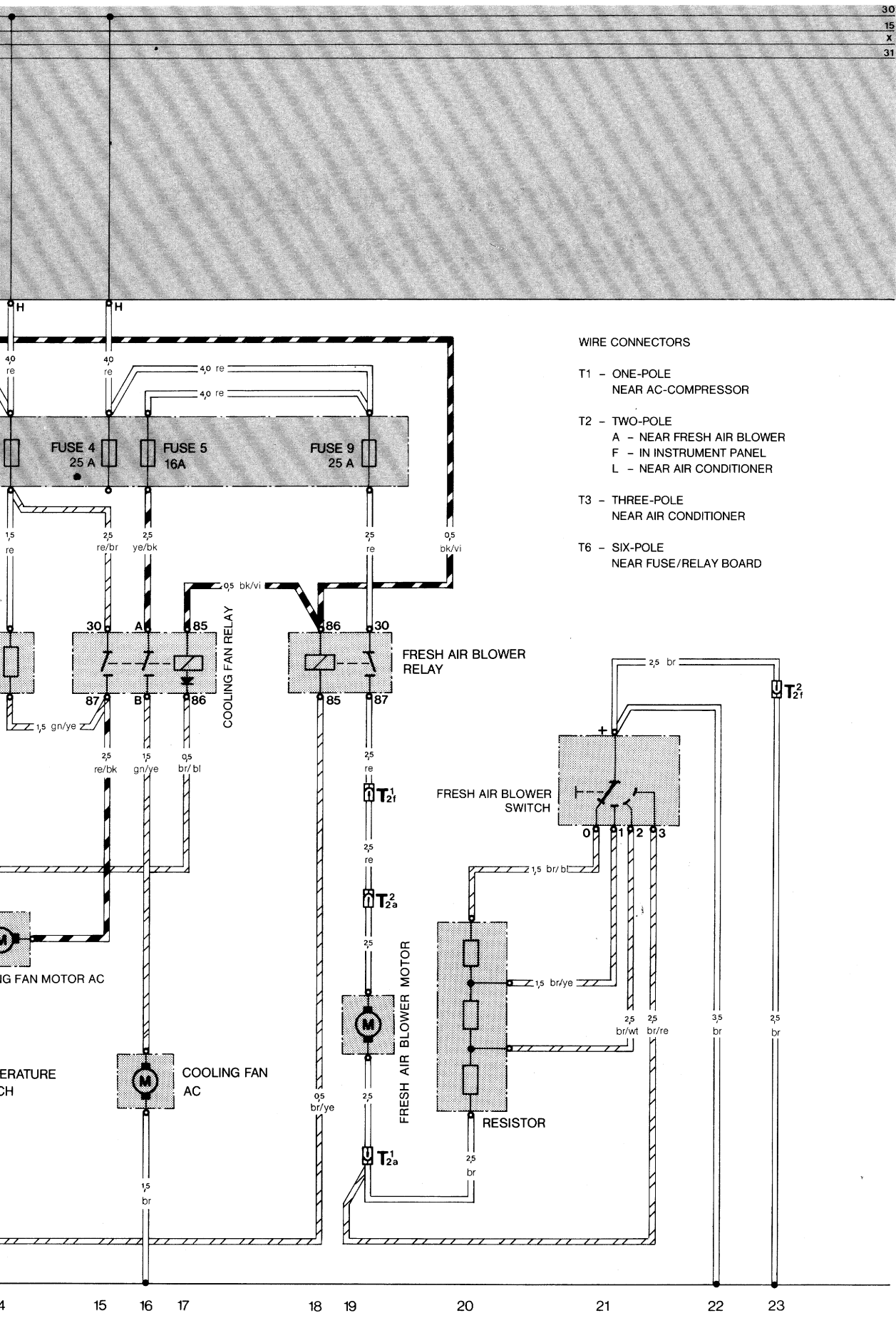

- WIRE CONNECTORS
- T1 - ONE-POLE
NEAR AC-COMPRESSOR
 - T2 - TWO-POLE
A - NEAR FRESH AIR BLOWER
F - IN INSTRUMENT PANEL
L - NEAR AIR CONDITIONER
 - T3 - THREE-POLE
NEAR AIR CONDITIONER
 - T6 - SIX-POLE
NEAR FUSE/RELAY BOARD

FRESH AIR BLOWER

Additional Current Flow Diagram Type 944

RADIO

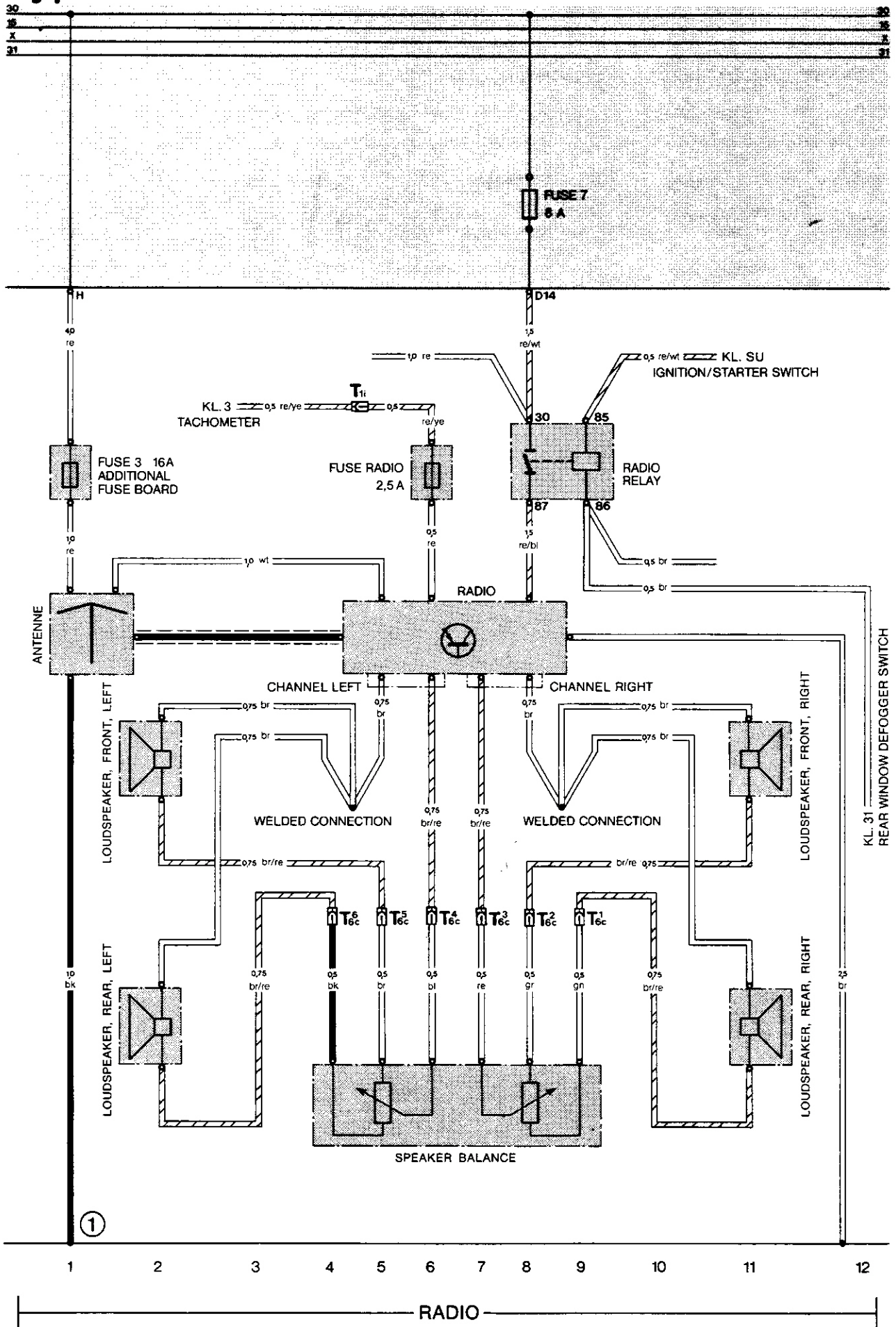

Current Flow Diagram Type 944 USA Model 84

PART I	POWER SUPPLY, STARTER DIGITAL MOTOR ELECTRONIC (DME) FUEL PUMP
PART II	LIGHT SWITCH, CONCEALING HEADLIGHT FOG LIGHTS HEADLIGHT PARKING LIGHT, REAR LIGHT
PART III	BRAKE LIGHT EMERGENCY FLASHER TURN SIGNAL, BACK-UP LIGHT HORN INTERIOR LIGHT
PART IV	REAR WINDOW DEFOGGER, IGNITION/STARTER SWITCH, SEAT BELTS BRAKE MONITOR INSTRUMENT CLUSTER
PART V	INSTRUMENTS CENTER CONSOLE WIND SHIELD WIPER REAR LID UNLOCKING
PART VI	FRESH AIR BLOWER COOLING FAN

Current Flow Diagram Type 944 USA

Model 84

WIRE CONNECTORS

T1 - ONE-POLE

- A - NEAR FUSE/RELAY BOARD
- B - IN ENGINE COMPARTMENT
- C - NEAR BRAKE BOOSTER
- D - IN INSTRUMENT PANEL
- E - ON REAR LID
- H - NEAR DOOR SWITCH, RIGHT
- I - NEAR RADIO
- K - NEAR DRIVER'S FOOTWELL, RIGHT

T2 - TWO-POLE

- A - NEAR FRESH AIR BLOWER
- B - IN INSTRUMENT PANEL
- F - NEAR FUSE/RELAY BOARD
- G - NEAR FUSE/RELAY BOARD
- H - NEAR ADDITIONAL TURN SIGNAL LEFT
- I - NEAR ADDITIONAL TURN SIGNAL RIGHT
- K - CENTER CONSOLE LEFT
- L - IN ENGINE COMPARTMENT
- M - NEAR FOG LIGHT, LEFT
- N - NEAR FOG LIGHT, RIGHT
- O - CENTER CONSOLE
- P - NEAR FUSE/RELAY BOARD
- Q - AT FRONT AXLE LEFT
- R - AT FRONT AXLE RIGHT
- S - AT REAR AXLE LEFT
- T - AT REAR AXLE RIGHT
- U - AT A-PILLAR LEFT
- V - ON LUGGAGE COMPARTMENT
- W - NEAR FUSE/RELAY BOARD

T3 - THREE-POLE

- B - NEAR HEADLIGHT, LEFT
- C - NEAR HEADLIGHT, RIGHT

T4 - FOUR-POLE

- A - NEAR FUSE/RELAY BOARD
- B - IN INSTRUMENT PANEL

T6 - SIX-POLE

- A - NEAR FUSE/RELAY BOARD
- B - IN CENTER CONSOLE
- C - NEAR FUSE/RELAY BOARD

T7 - SEVEN-POLE

- B - NEAR RIGHT REAR LIGHTS
- C - NEAR LEFT REAR LIGHTS
- G - IN ENGINE COMPARTMENT

T8 - EIGHT-POLE

- IN LUGGAGE COMPARTMENT

T9 - NINE-POLE

- A - IN ENGINE COMPARTMENT
- B - NEAR FUSE/RELAY BOARD

GROUND TERMINALS

- ① NEAR FUSE/RELAY BOARD
- ② IN LUGGAGE COMPARTMENT, NEAR LEFT REAR LIGHT
- ③ NEAR DISTRIBUTOR
- ④ NEAR LEFT HEADLIGHT
- ⑤ NEAR RIGHT HEADLIGHT

WIRE COLOURS

- | | | |
|------------|-------------|-------------|
| BK - BLACK | GN - GREEN | BR - BROWN |
| WT - WHITE | YE - YELLOW | BL - BLUE |
| RE - RED | GR - GREY | VI - VIOLET |

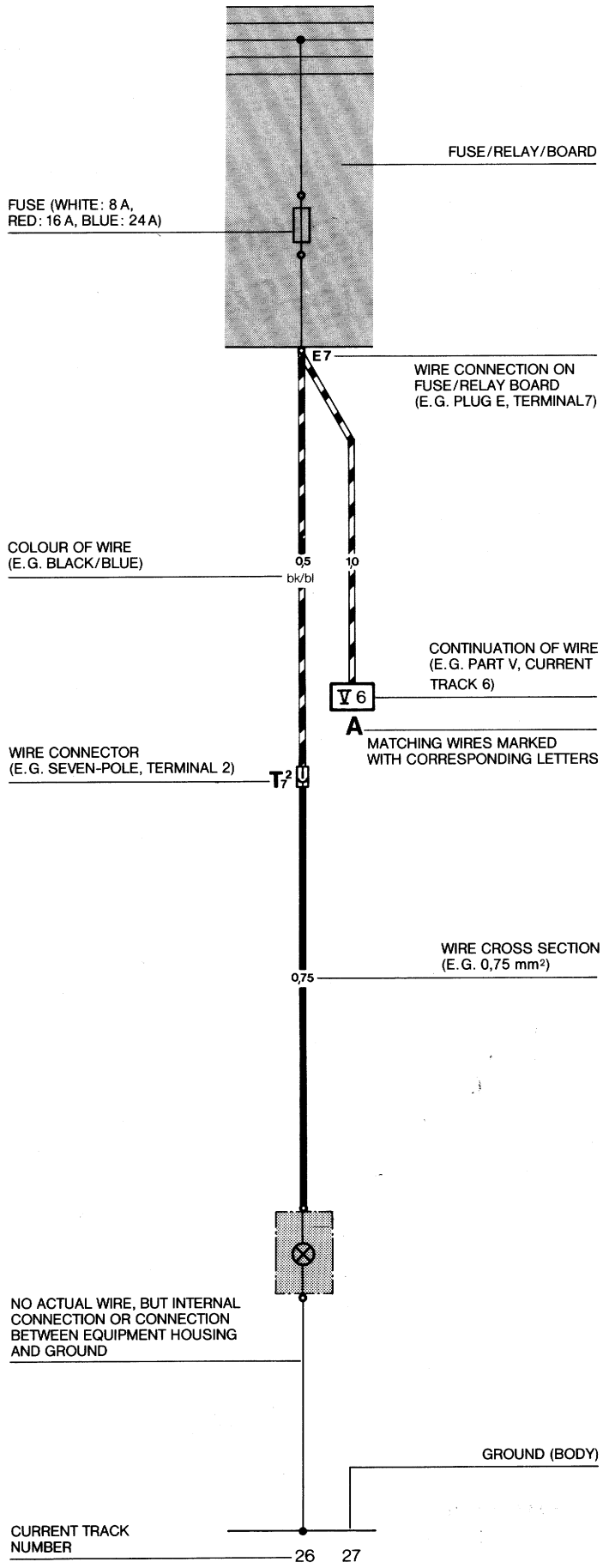

Current Flow Diagram Type 944 USA Model 84 Part I

POWER SUPPLY, STARTER
DIGITAL MOTOR ELECTRONIC (DME)
FUEL PUMP

Current Flow Diagram Type 944 USA Model 84 Pa

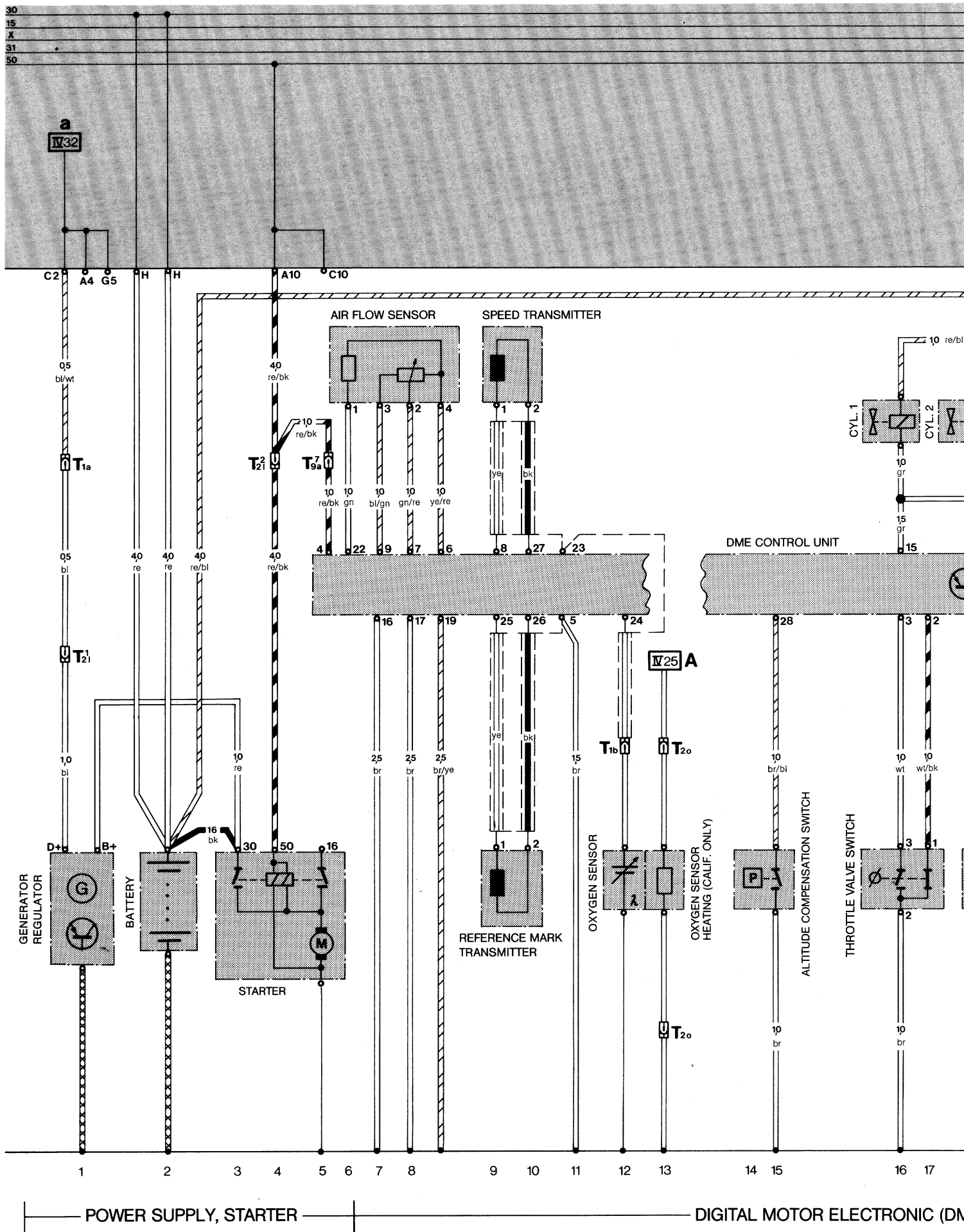

30
15
X
31
50

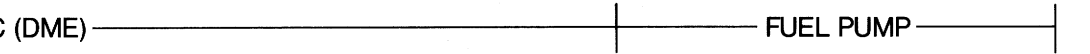
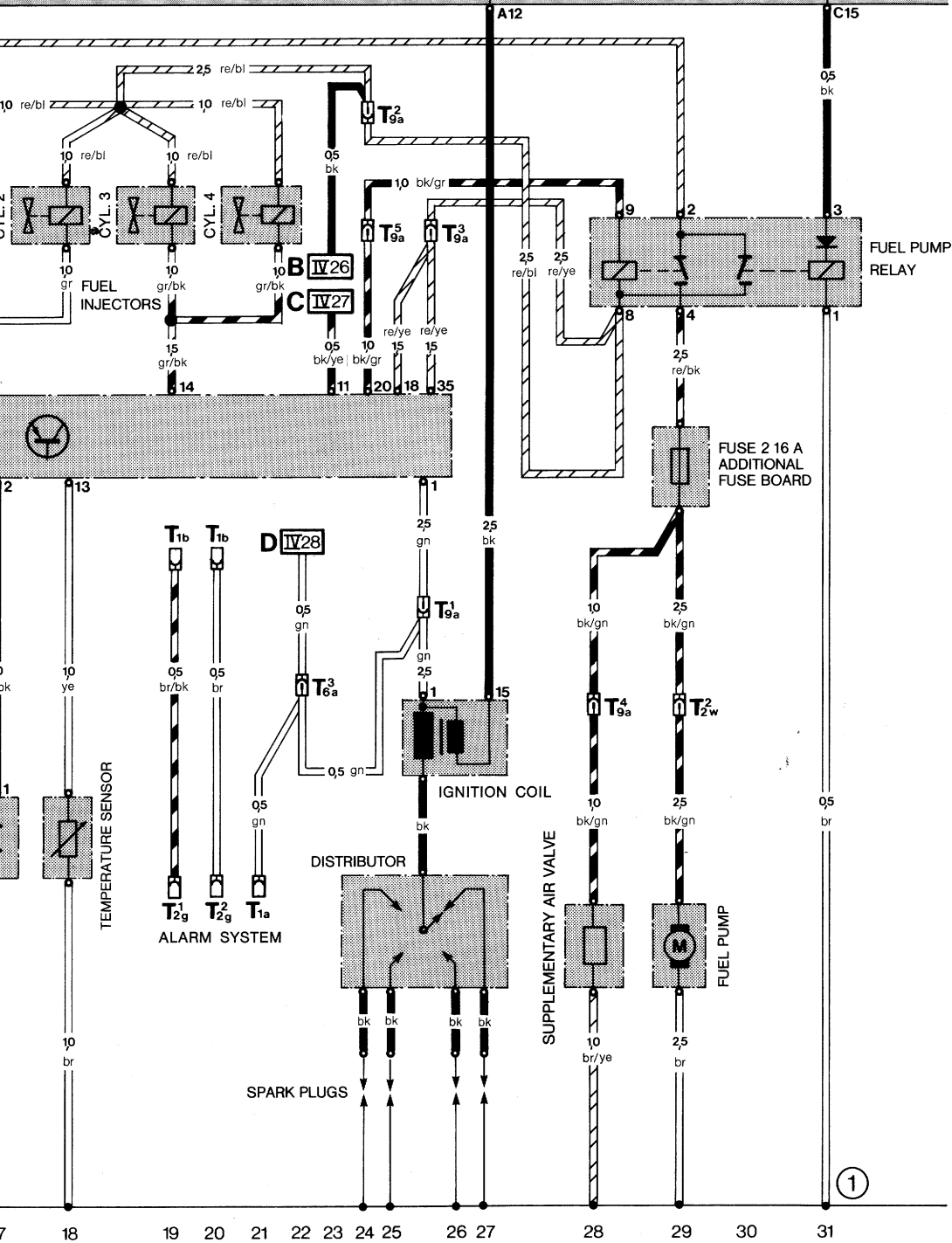

Current Flow Diagram Type 944 USA Model 84 Part II

LIGHT SWITCH, CONCEALING HEADLIGHT

FOG LIGHTS

HEADLIGHT

PARKING LIGHT, REAR LIGHT

Current Flow Diagram Type 944 USA Model 84 Part

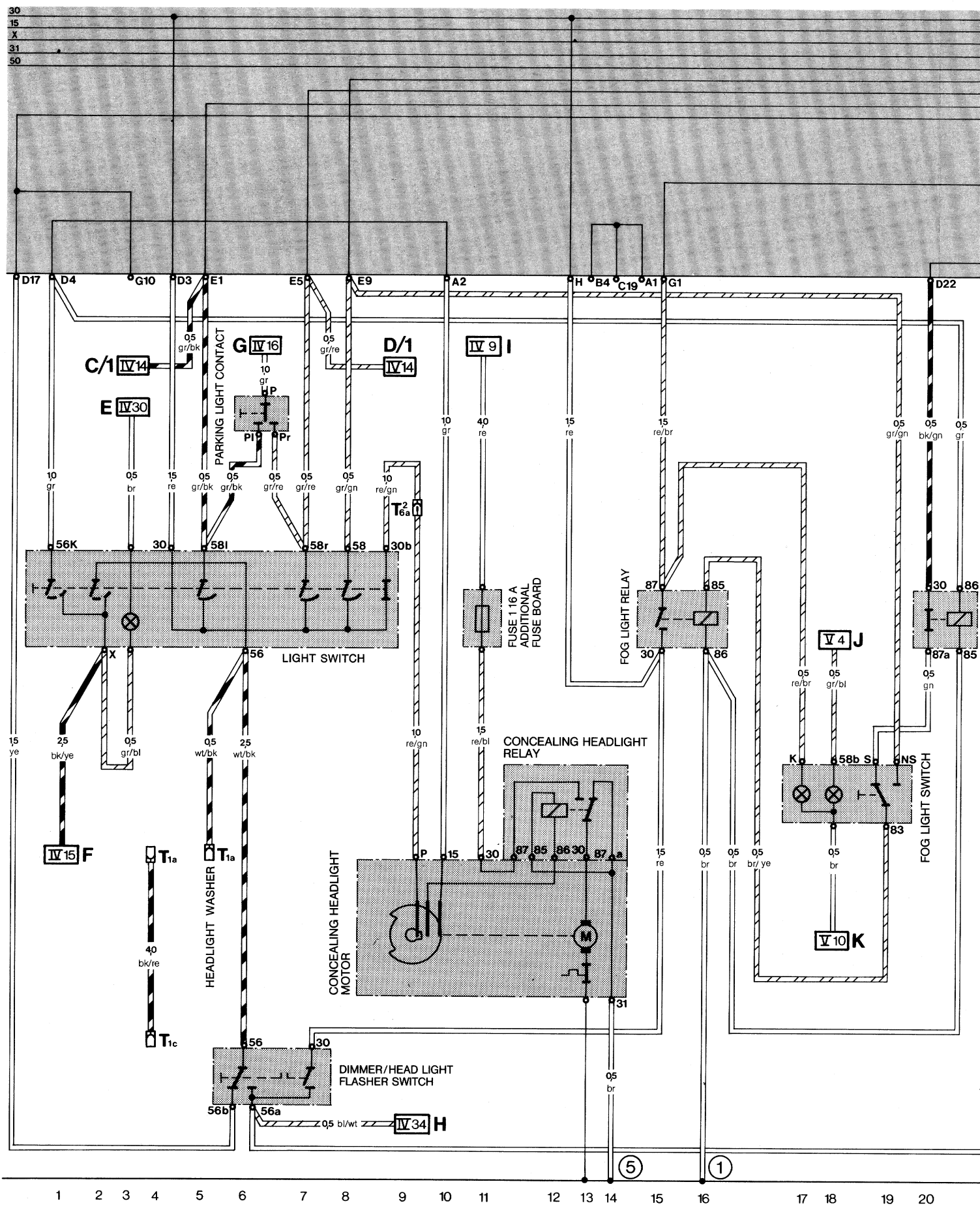

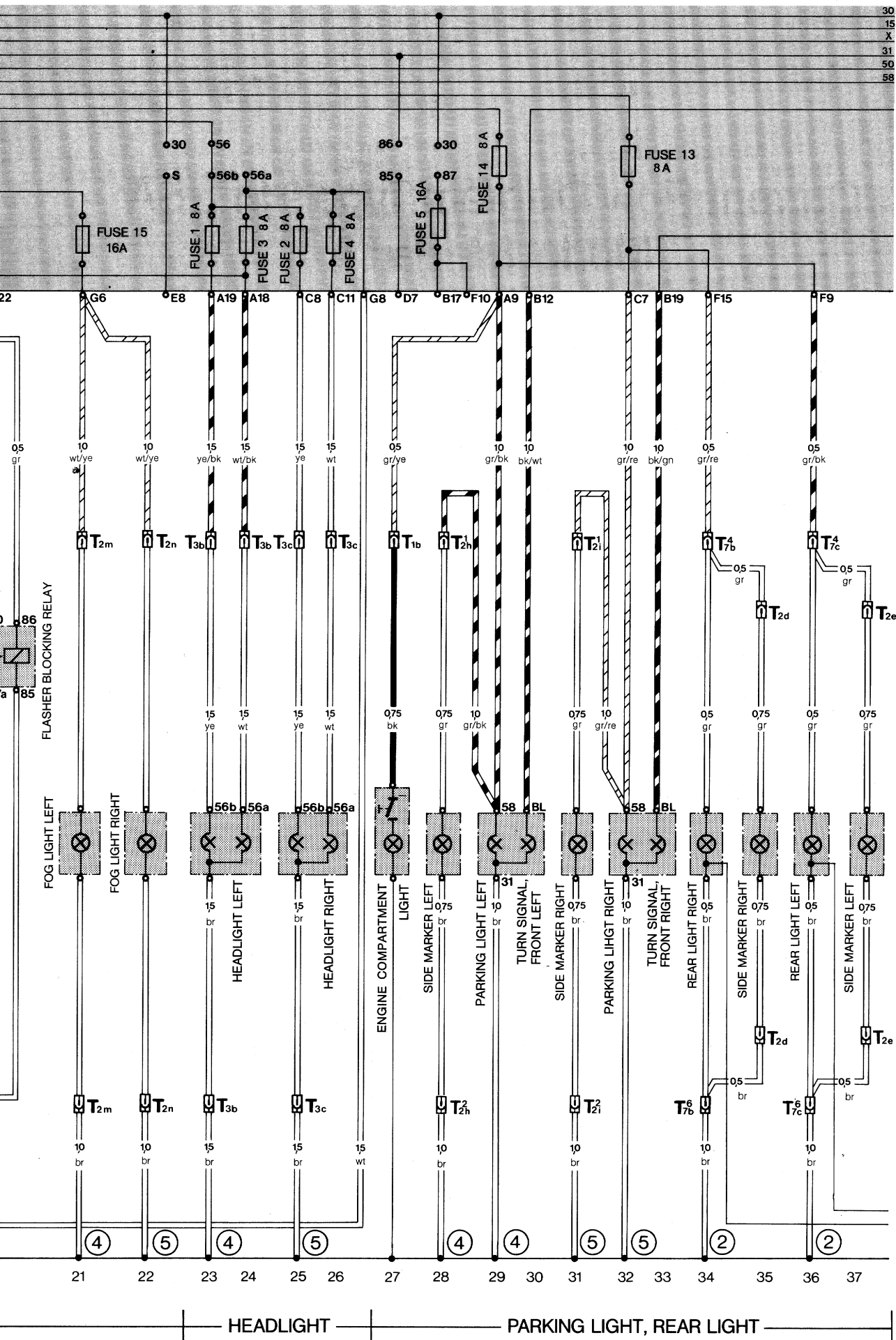

Current Flow Diagram Type 944 USA Model 84 Part III

BRAKE LIGHT
EMERGENCY FLASHER
TURN SIGNAL, BACK-UP LIGHT
HORN
INTERIOR LIGHT

Current Flow Diagram Type 944 USA Model 84 Part

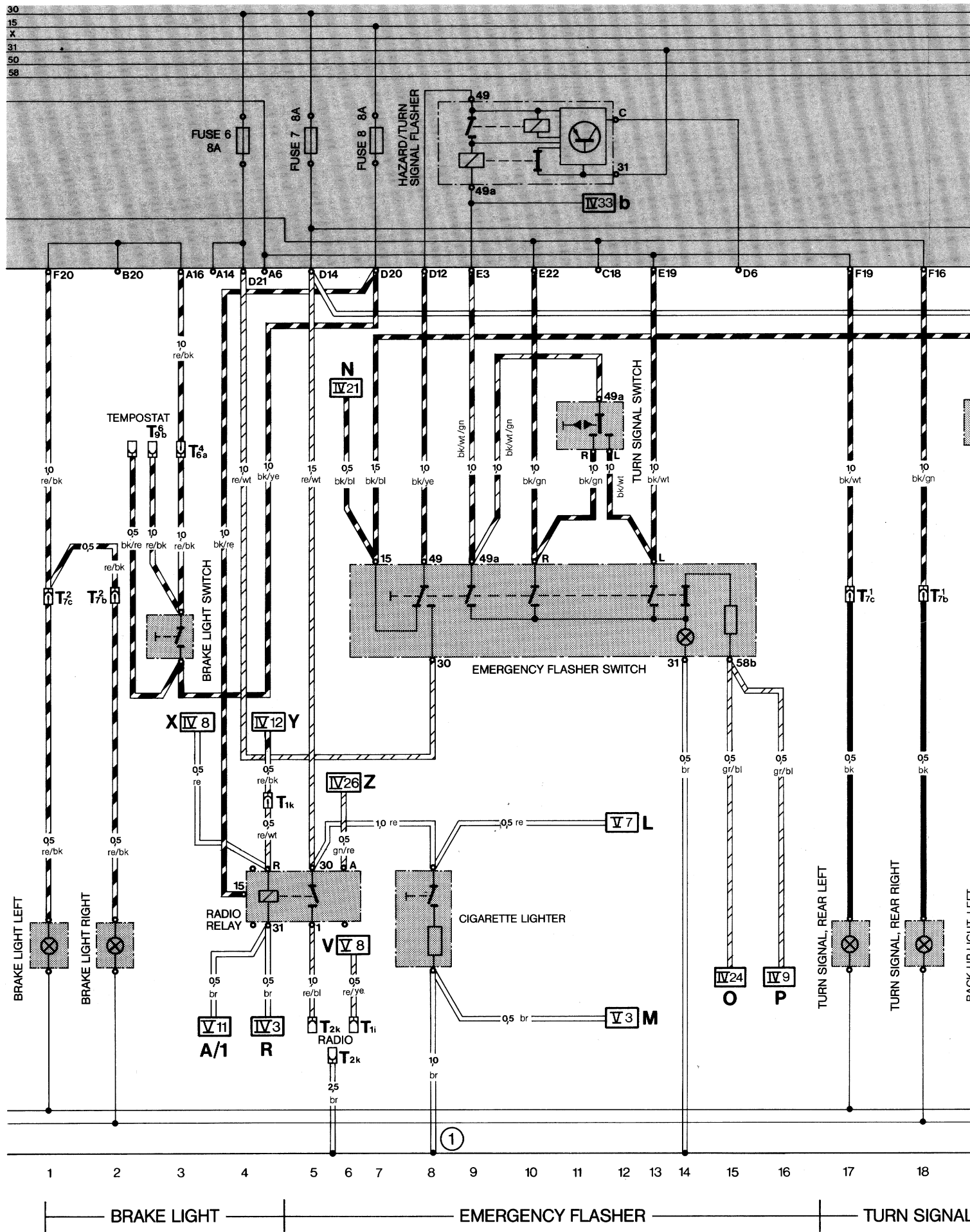

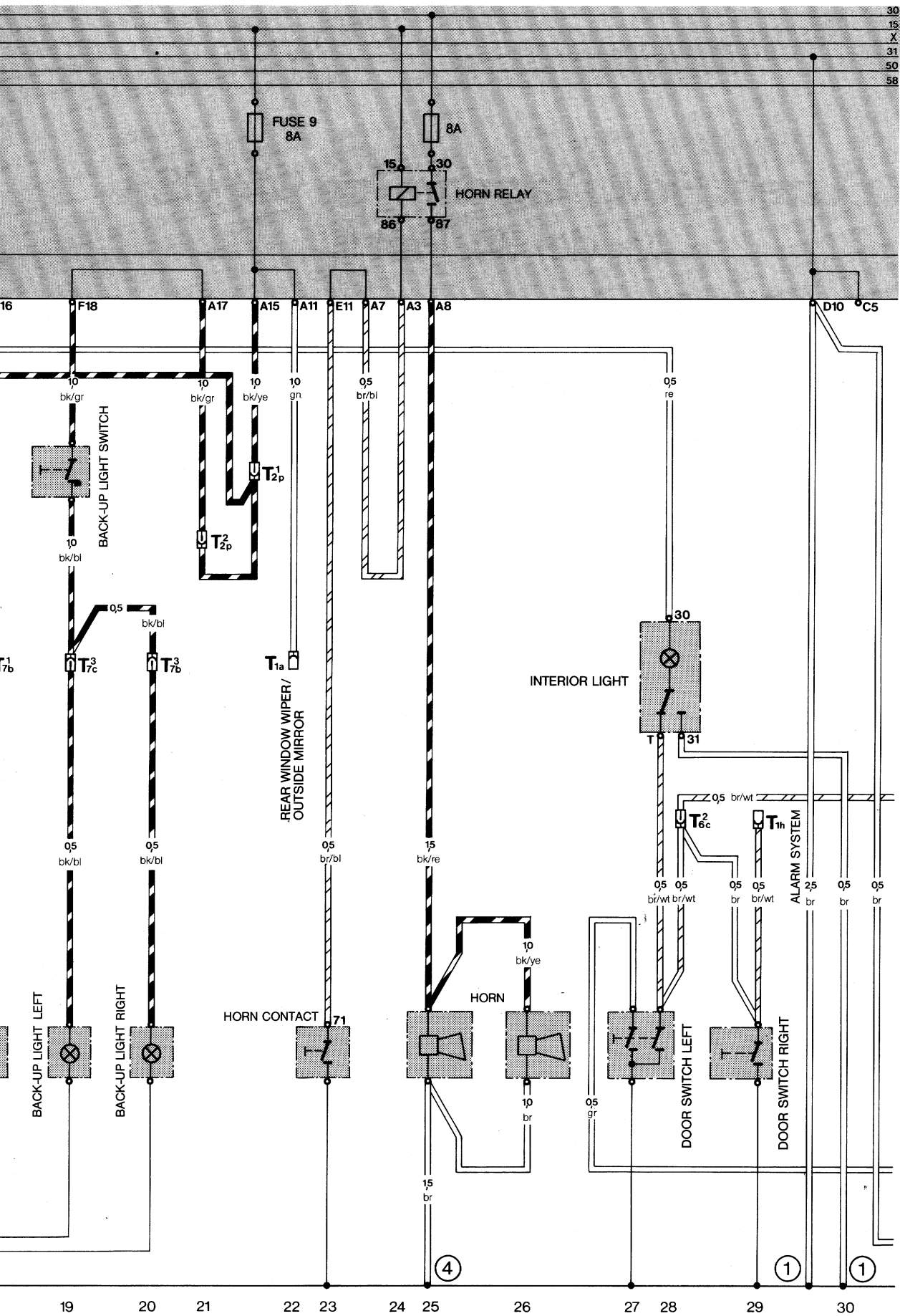

Current Flow Diagram Type 944 USA Model 84 Part IV

REAR WINDOW DEFOGGER,
IGNITION/STARTER SWITCH, SEAT BELTS
BRAKE MONITOR
INSTRUMENT CLUSTER

Current Flow Diagram Type 944 USA Model 84 Part

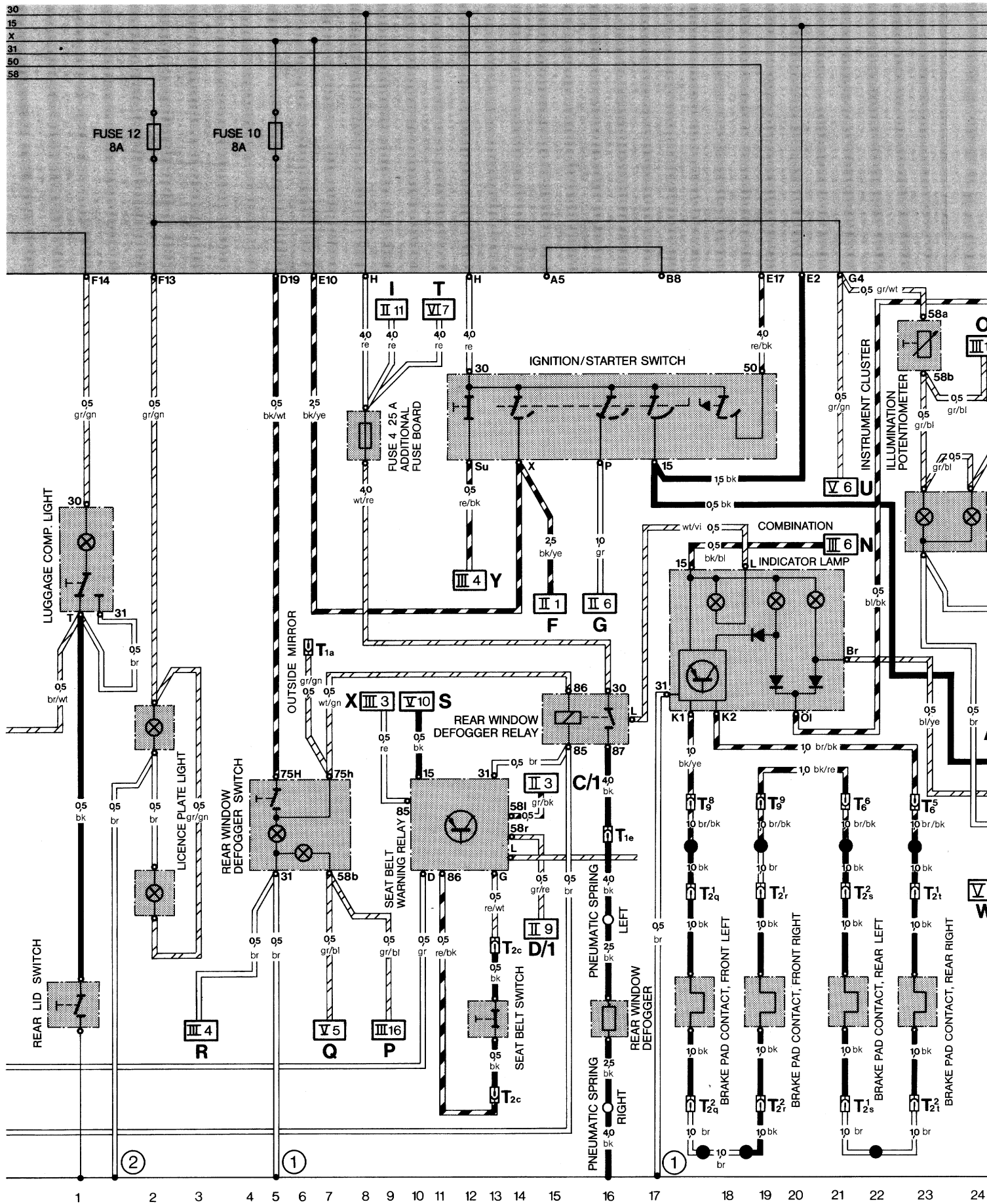

REAR WINDOW DEFOGGER, IGNITION/STARTER SWITCH, SEAT BELTS, BRAKE M

30
15
X
31

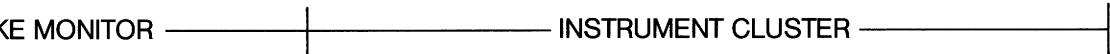
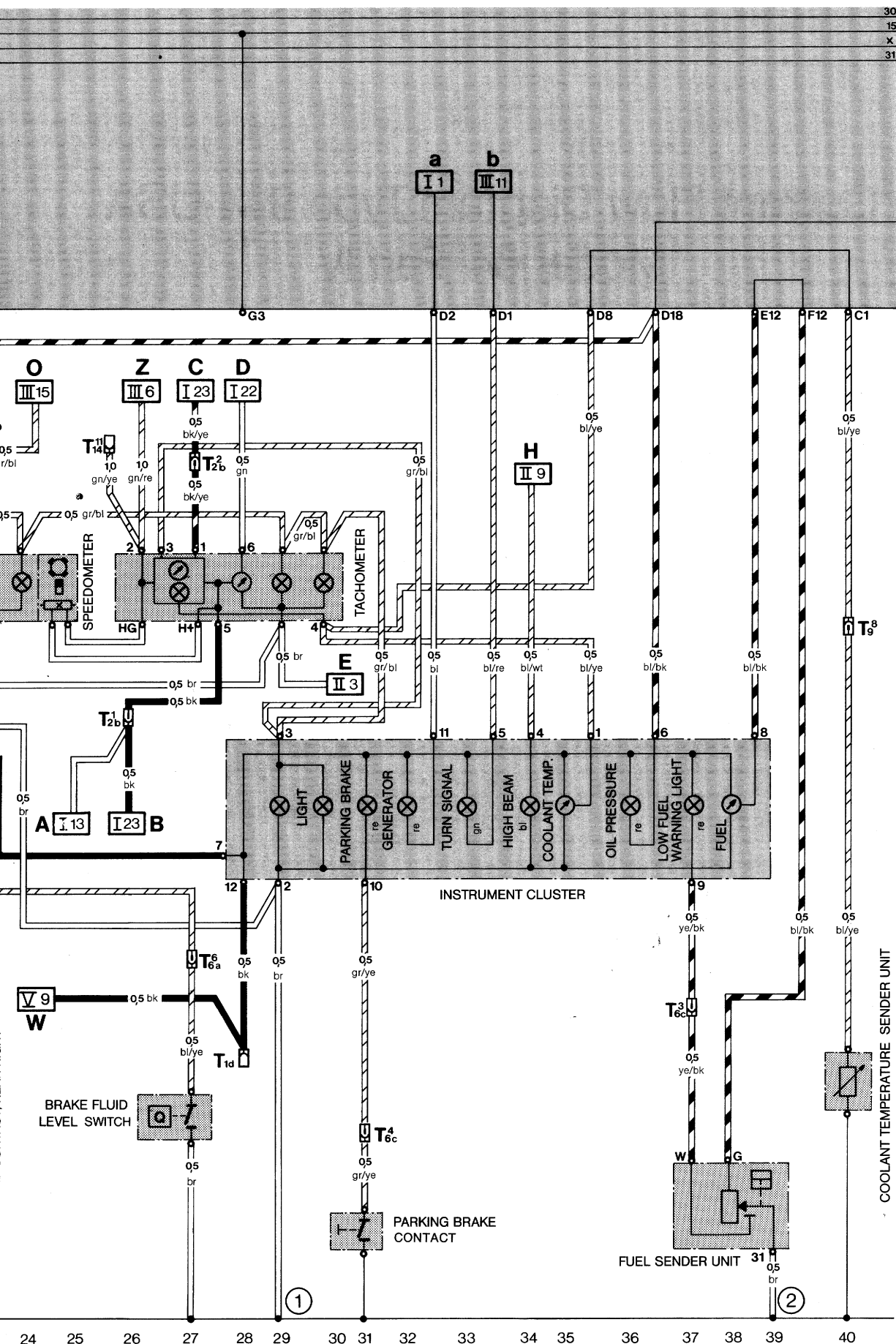

Current Flow Diagram

Current Flow Diagram Type 944 USA Model 84 Part V

INSTRUMENTS CENTER CONSOLE

WIND SHIELD WIPER

REAR LID UNLOCKING

Current Flow Diagram Type 944 USA Model 84 Part

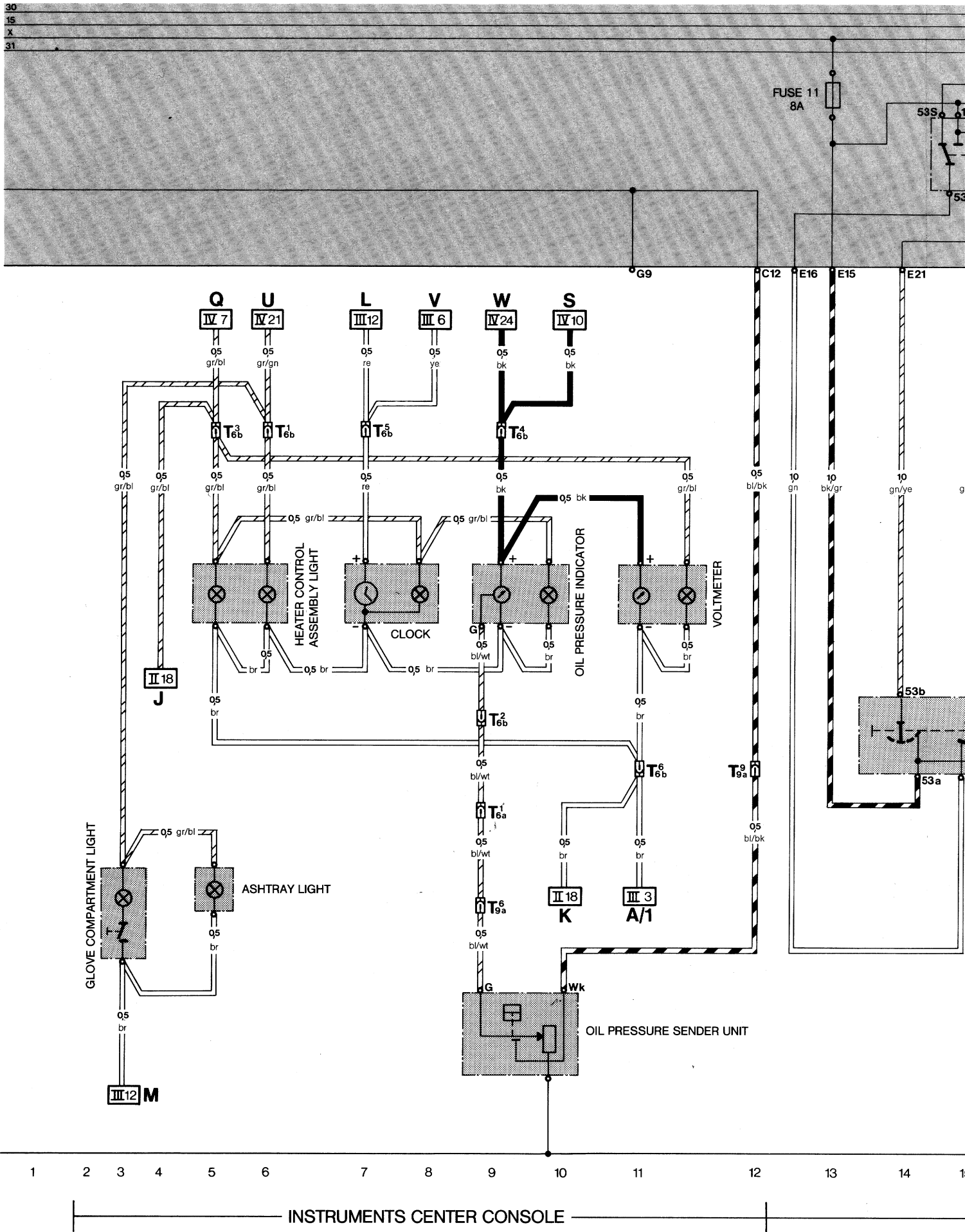

30
15
X
31

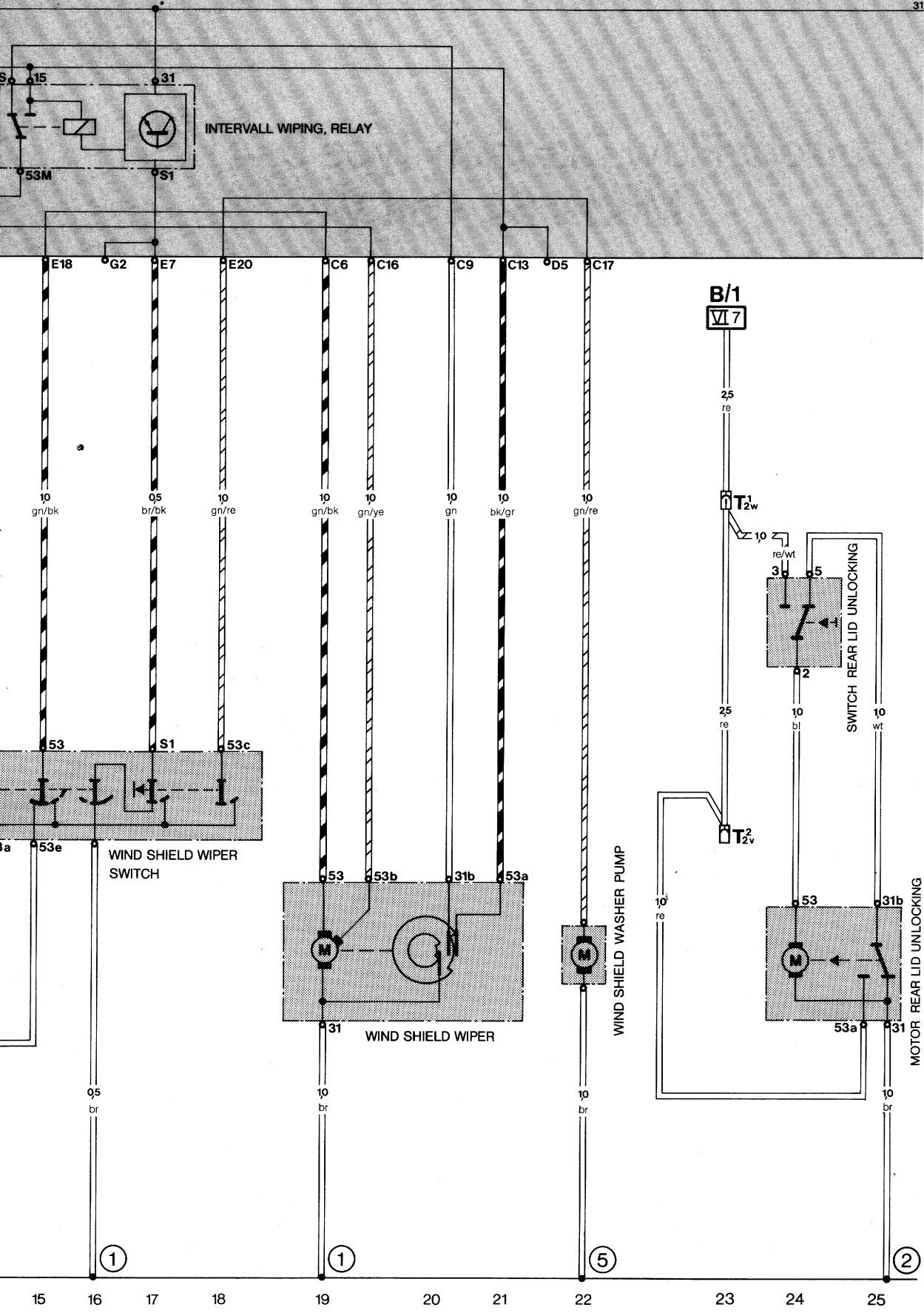

WIND SHIELD WIPER

REAR LID UNLOCKING

Current Flow Diagram

Type 944 USA Model 84 Part VI

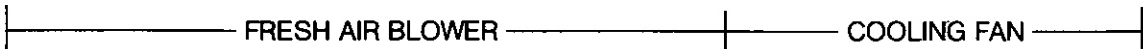
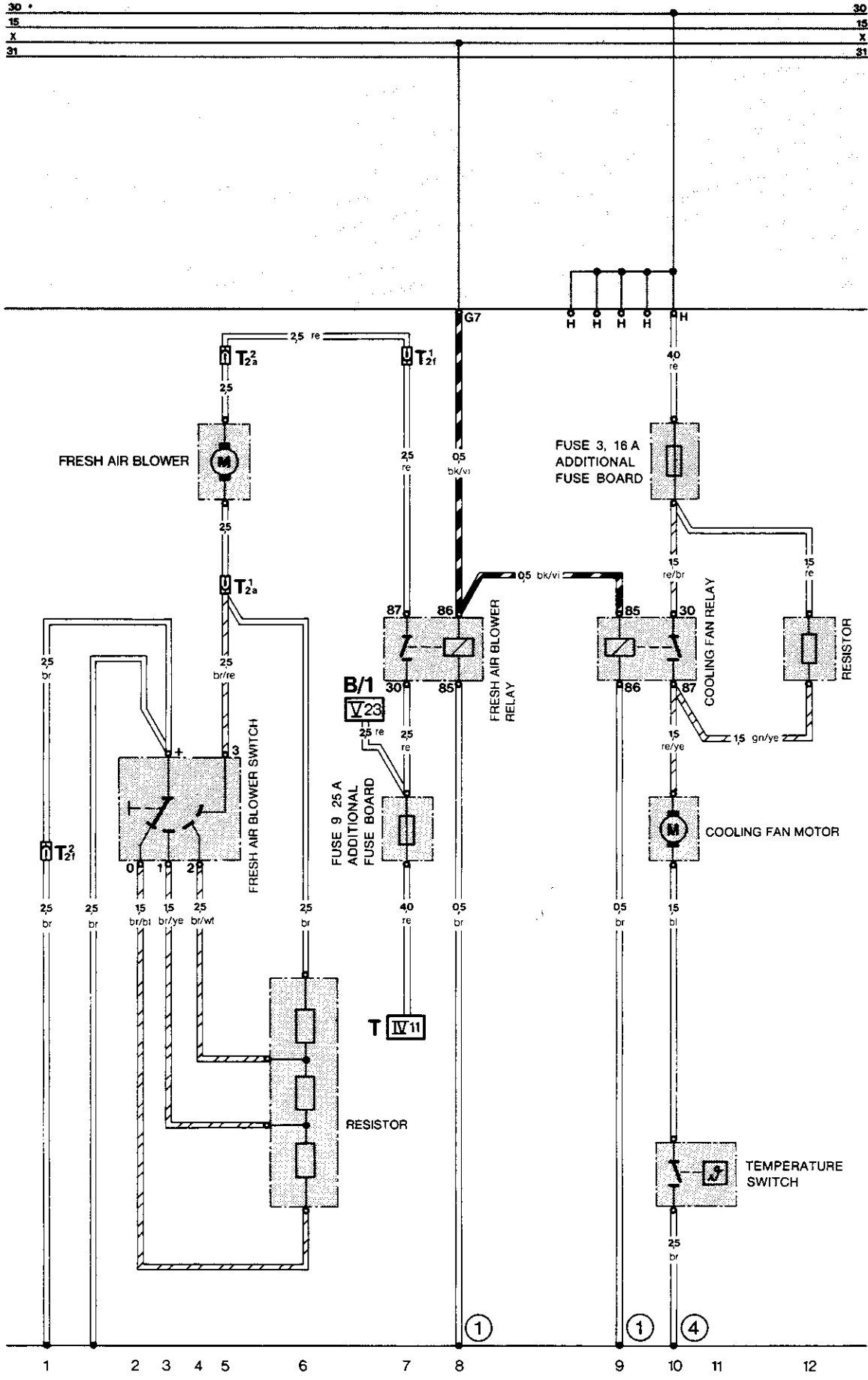

Additional Current Flow Diagram Type 944 USA

AIR CONDITIONER

Additional Current Flow Diagram Type 944 USA A

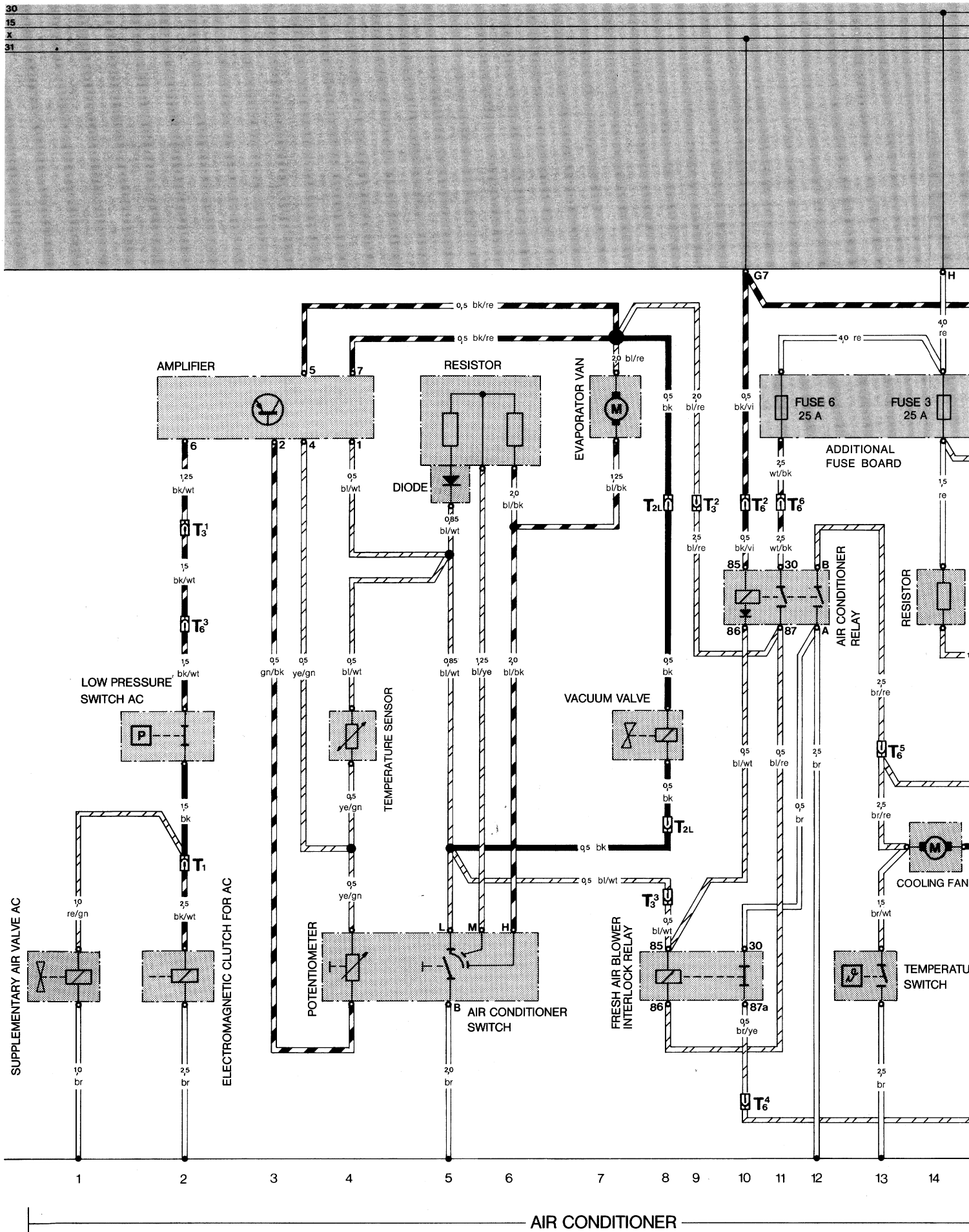

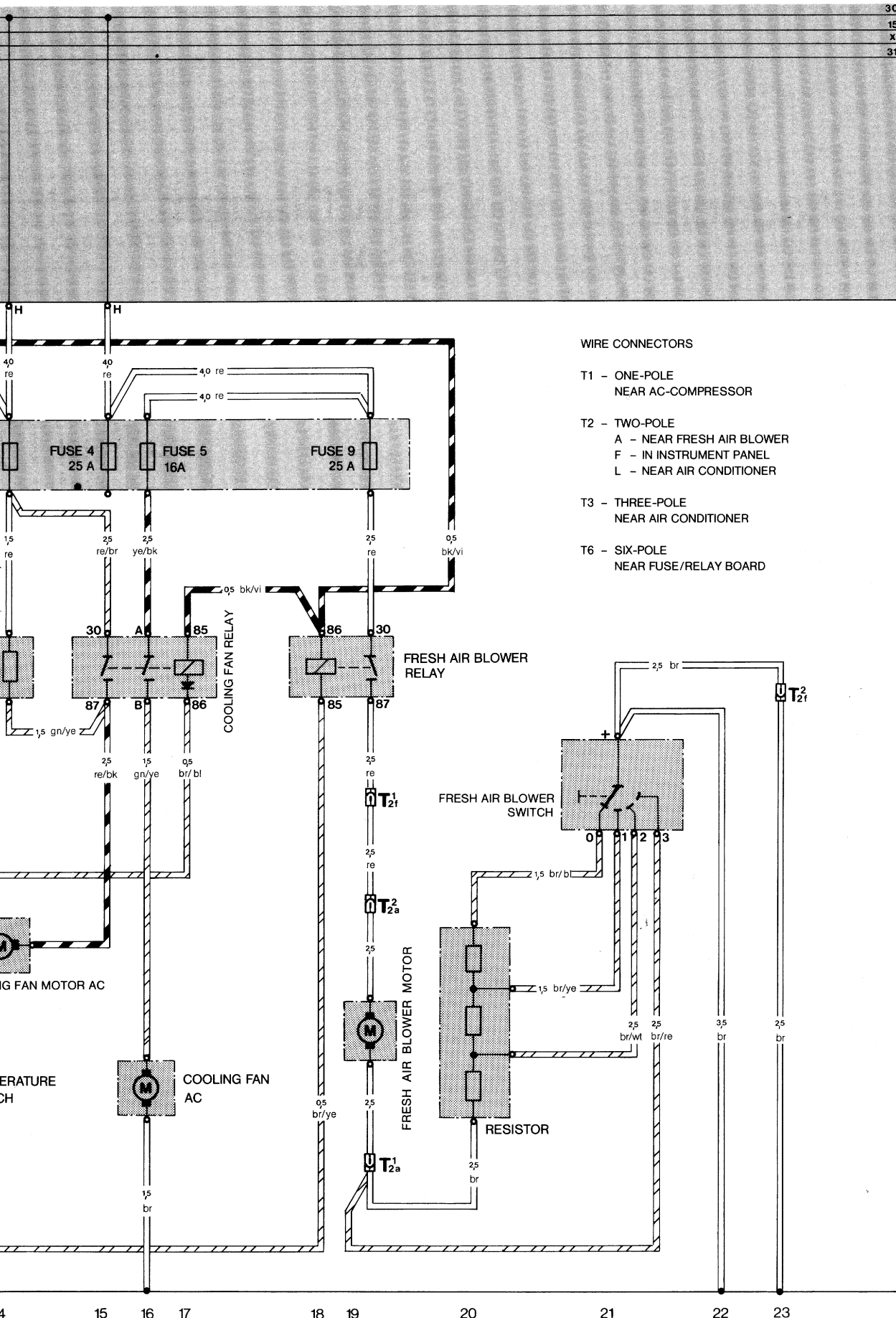

WIRE CONNECTORS

- T1 - ONE-POLE
NEAR AC-COMPRESSOR
- T2 - TWO-POLE
A - NEAR FRESH AIR BLOWER
F - IN INSTRUMENT PANEL
L - NEAR AIR CONDITIONER
- T3 - THREE-POLE
NEAR AIR CONDITIONER
- T6 - SIX-POLE
NEAR FUSE/RELAY BOARD

FRESH AIR BLOWER

Additional Current Flow Diagram Type 944 Modell 84

ELECTRIC WINDOW CONTROL

USA

97

Wiring

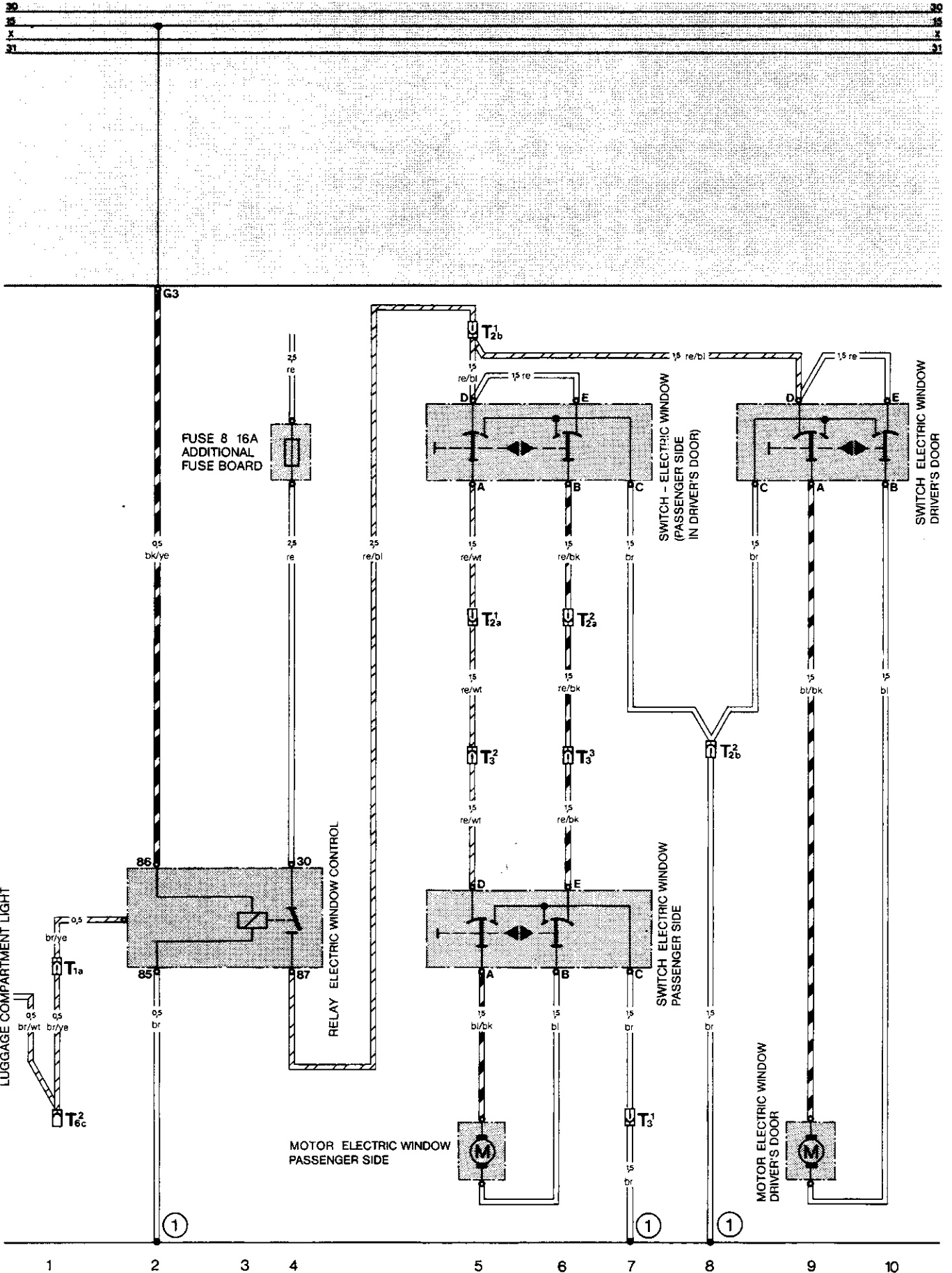

Additional Current Flow Diagram Type 944 Modell 84

LIFTING ROOF

USA

97

Wiring

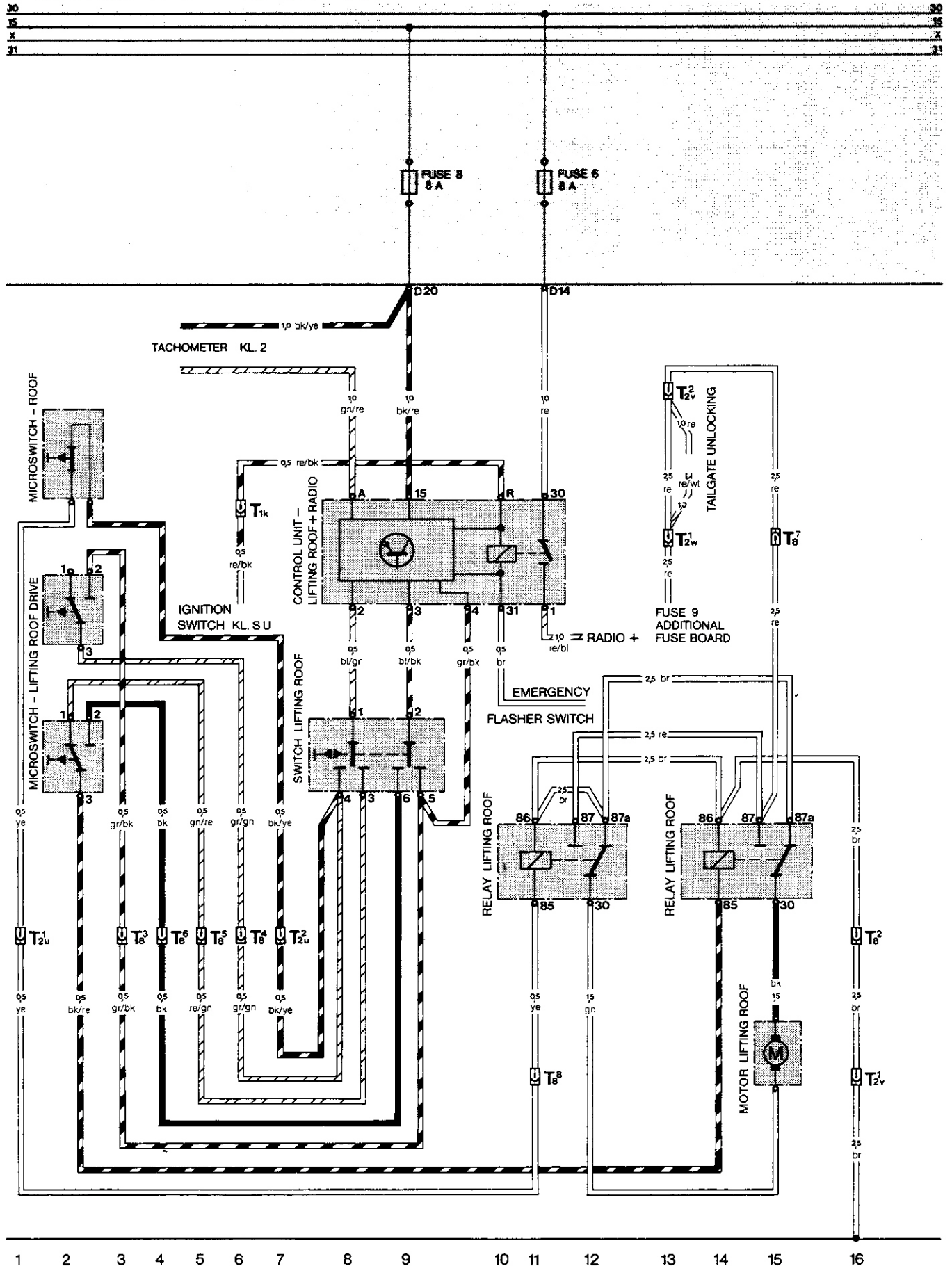

Additional Current Flow Diagram Type 944 Modell 84 TEMPOSTAT

97
Wiring

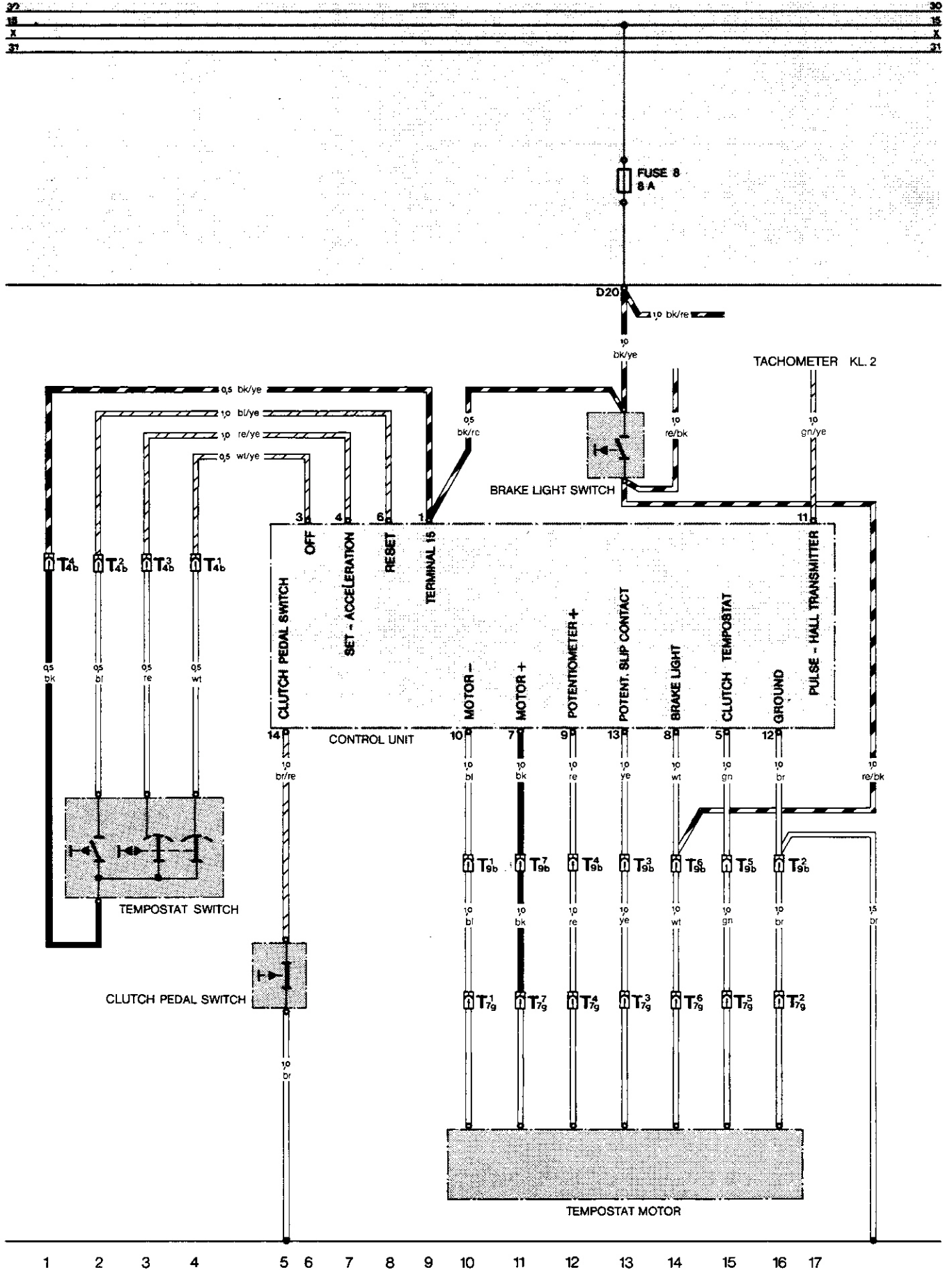

Wiring Diagram Type 944, 944 turbo Model 85/2

SHEET 1	LIGHTING ROW/SA
SHEET 2	LIGHTING USA
SHEET 3	INSTRUMENT CLUSTER AND SENSORS ROW
SHEET 4	INSTRUMENT CLUSTER AND SENSORS USA/SA
SHEET 5	HEATING, A/C, VENTILATION, ELECTR. SEATS, WIPER AND WASHER SYSTEM
SHEET 6	HORNS, MIRRORS, WINDOW LIFTERS, ALARM SYSTEM, TILTING ROOF
SHEET 7	ENGINE COMPARTMENT
SHEET 8	CENTRAL-ELECTRICS BOX

Attention!

Only for vehicles up to vehicle identification No.

**94 FN 40 1638
95 FN 10 0122**

**94 FN 45 1912
95 FN 15 0106**

Wiring Diagram Type 944, 944 turbo Model 85/2

The 944, 85/2 model, is being accompanied by a new generation of wiring diagrams.

The wiring diagram consists of eight individual wiring diagrams. These are divided into coordinate fields.

Each individual wiring diagram contains a part of the central-electrics box in a dash-dotted frame.

This part of the central-electrics box shows all the lines and relays necessary for the individual wiring diagram.

The earth/ground points are identified by "MP" and their location is shown in a vehicle diagram.

The 20-pin connectors on the central-electrics box are new. They are clipped together out of 5 parts.

Part 1, with the moulded-on fastening lug, is the "starting element".

Parts 2, 3 and 4 are "module elements".

Parts 1 to 4 are identified by the numbers 1 5.

Part 5 is a "coding element".

The designations of the plug connections in the wiring diagram of the central-electrics box refer to the "starting element" from, for example, B 11 15, and to the first module element from B 21 25.

Wiring Diagram Type 944, 944 turbo
Model 85/2 page 1

LIGHTING ROW/SA

Attention!

Only for vehicles up to vehicle identification No.

94 FN 40 1638

95 FN 10 0122

94 FN 45 1912

95 FN 15 0106

Wiring Diagram Type 944, 944 turbo Model 85/2 page 1

LIGHTING ROW/SA

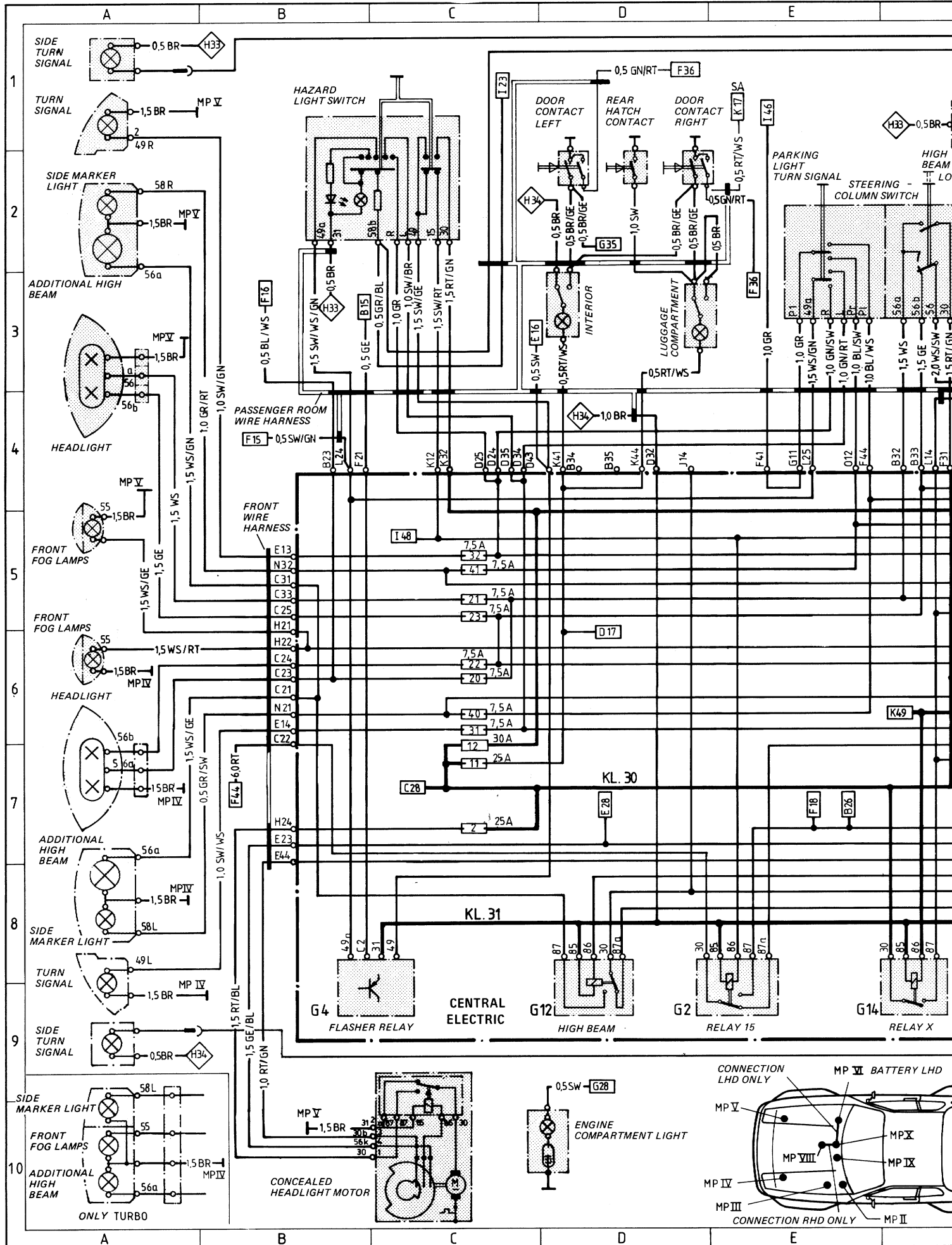

Wiring Diagram Type 944, 944 turbo
Model 85/2 page 2

LIGHTING USA

Attention!

Only for vehicles up to vehicle identification No.

**94 FN 40 1638
95 FN 10 0122**

**94 FN 45 1912
95 FN 15 0106**

LIGHTING USA

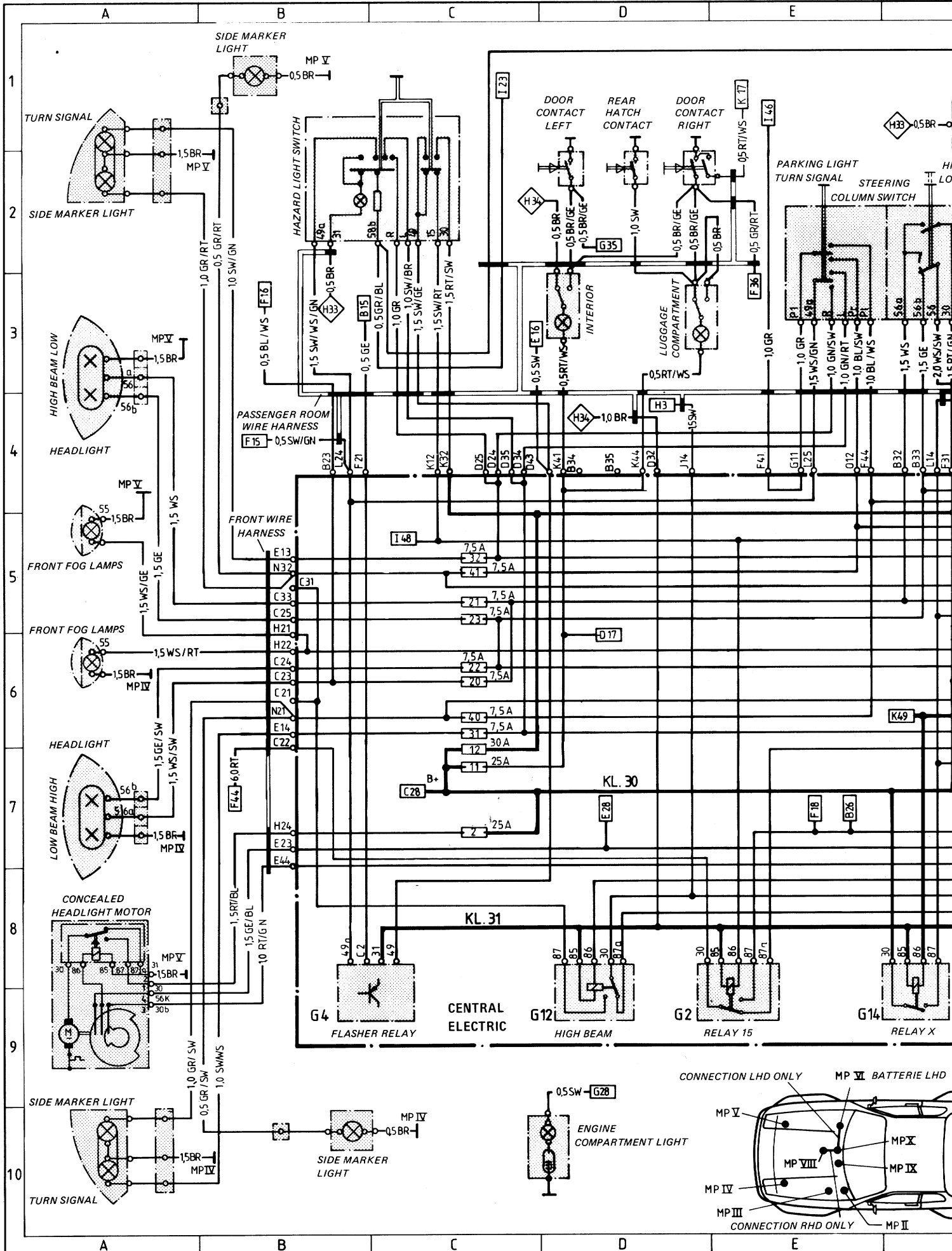

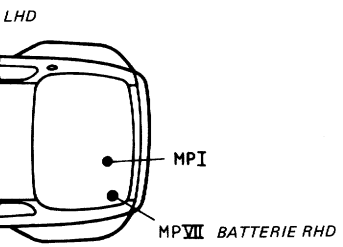
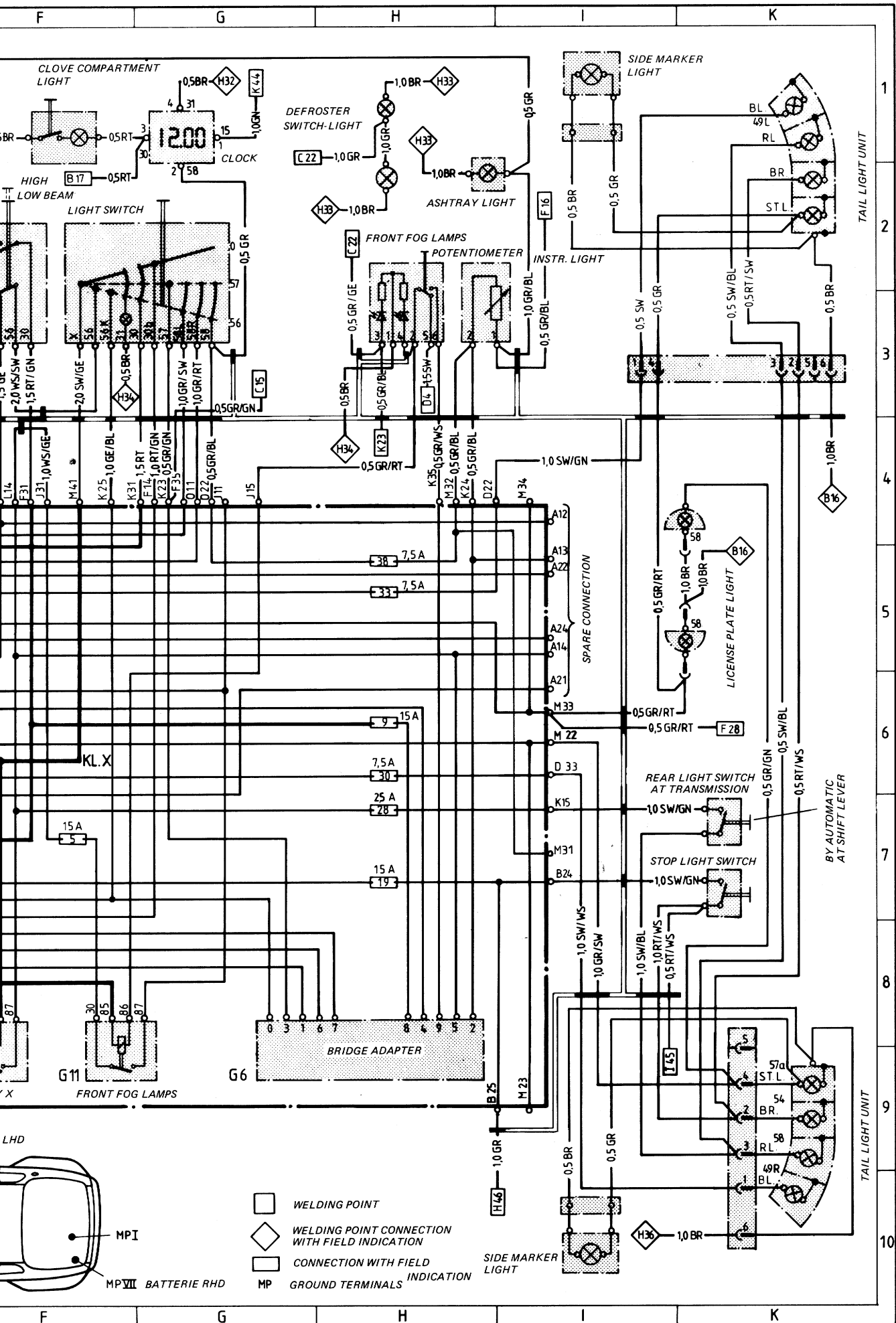

- WELDING POINT
- ◇ WELDING POINT CONNECTION WITH FIELD INDICATION
- ▭ CONNECTION WITH FIELD INDICATION
- MP GROUND TERMINALS

SIDE MARKER LIGHT

TAIL LIGHT UNIT

TAIL LIGHT UNIT

BY AUTOMATIC AT SHIFT LEVER

Wiring Diagram Type 944, 944 turbo
Model 85/2 page 3

INSTRUMENT CLUSTER AND SENSORS
ROW

Attention!

Only for vehicles up to vehicle identification No.

**94 FN 40 1638
95 FN 10 0122**

**94 FN 45 1912
95 FN 15 0106**

Wiring Diagram Type 944, 944 turbo Model 85/2 page 3

INSTRUMENT CLUSTER AND SENSORS ROW

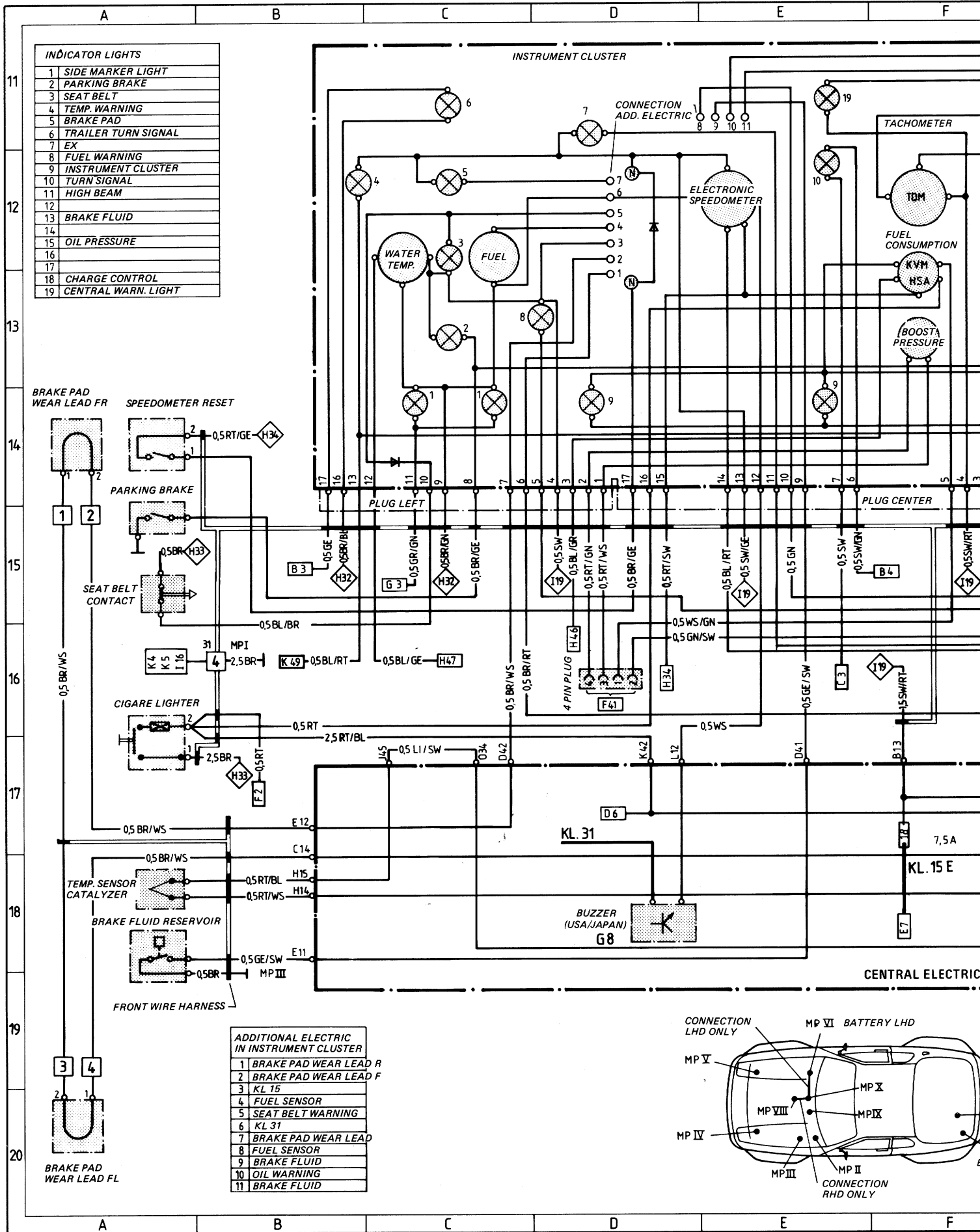

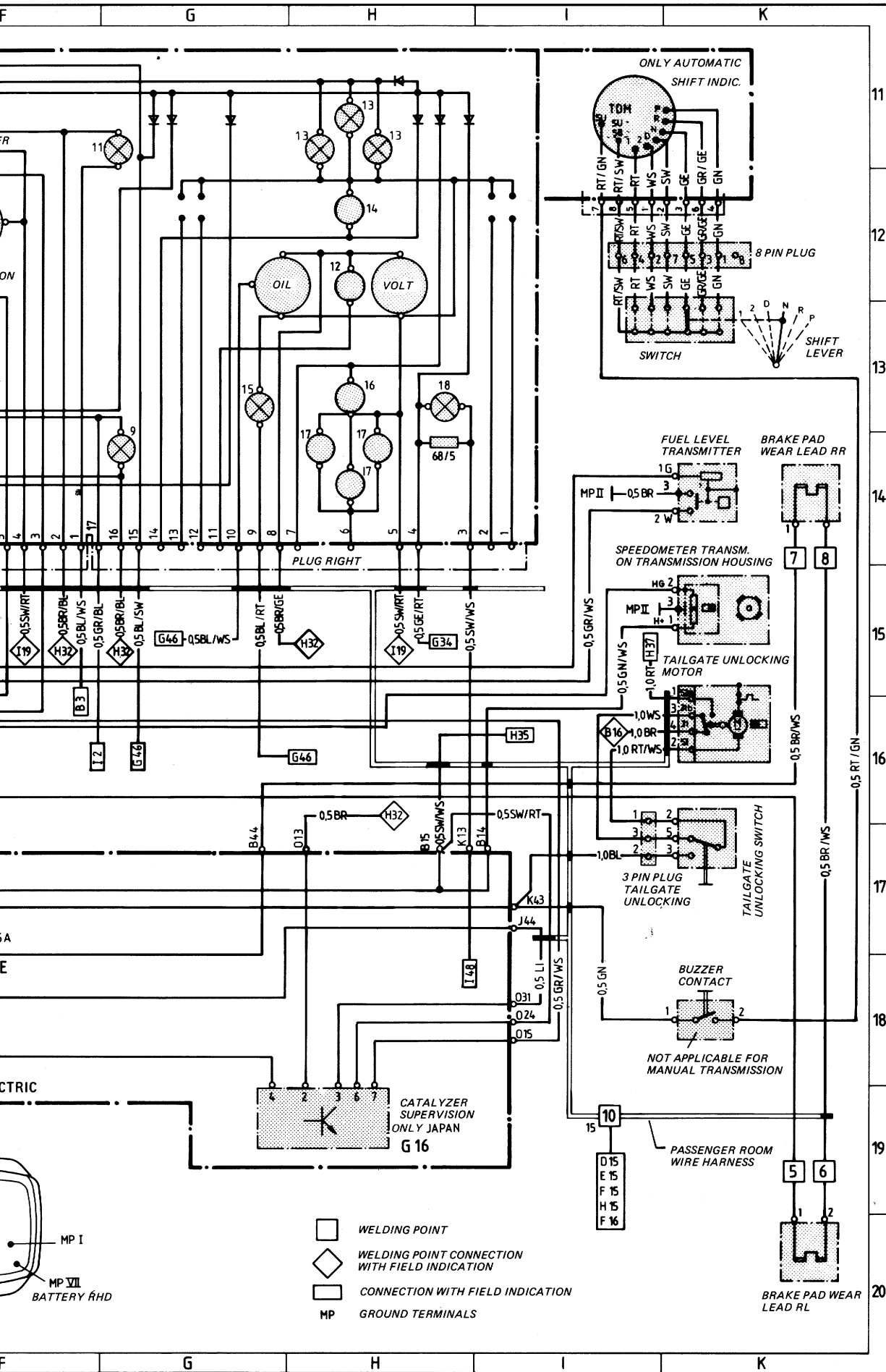

- WELDING POINT
- WELDING POINT CONNECTION WITH FIELD INDICATION
- CONNECTION WITH FIELD INDICATION
- MP GROUND TERMINALS

Wiring Diagram Type 944, 944 turbo Model 85/2 page 4

INSTRUMENT CLUSTER AND SENSORS
USA/SA

Attention!

Only for vehicles up to vehicle identification No.

**94 FN 40 1638
95 FN 10 0122**

**94 FN 45 1912
95 FN 15 0106**

Wiring Diagram Type 944, 944 turbo Model 85/2 page 4

INSTRUMENT CLUSTER AND SENSORS USA/SA

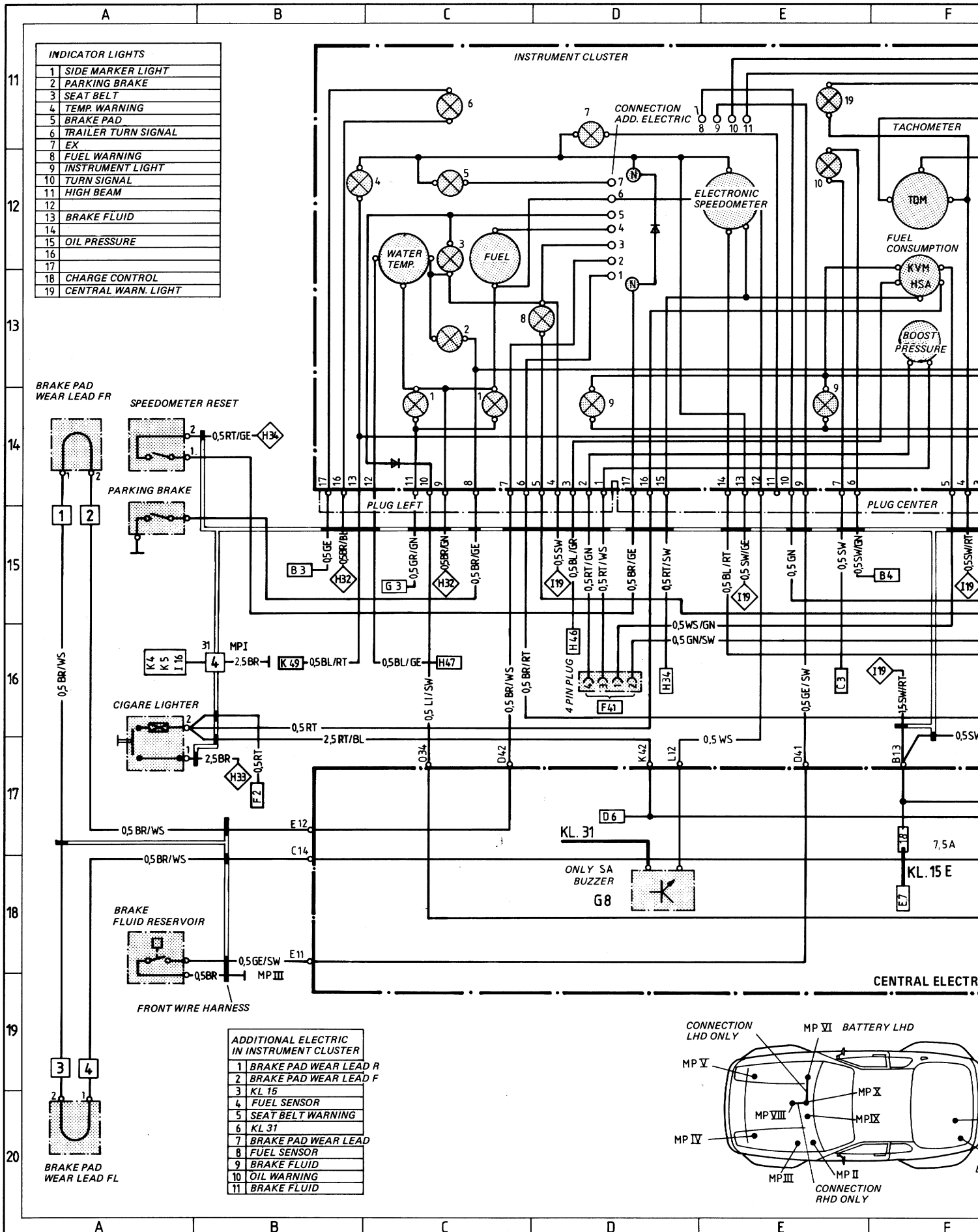

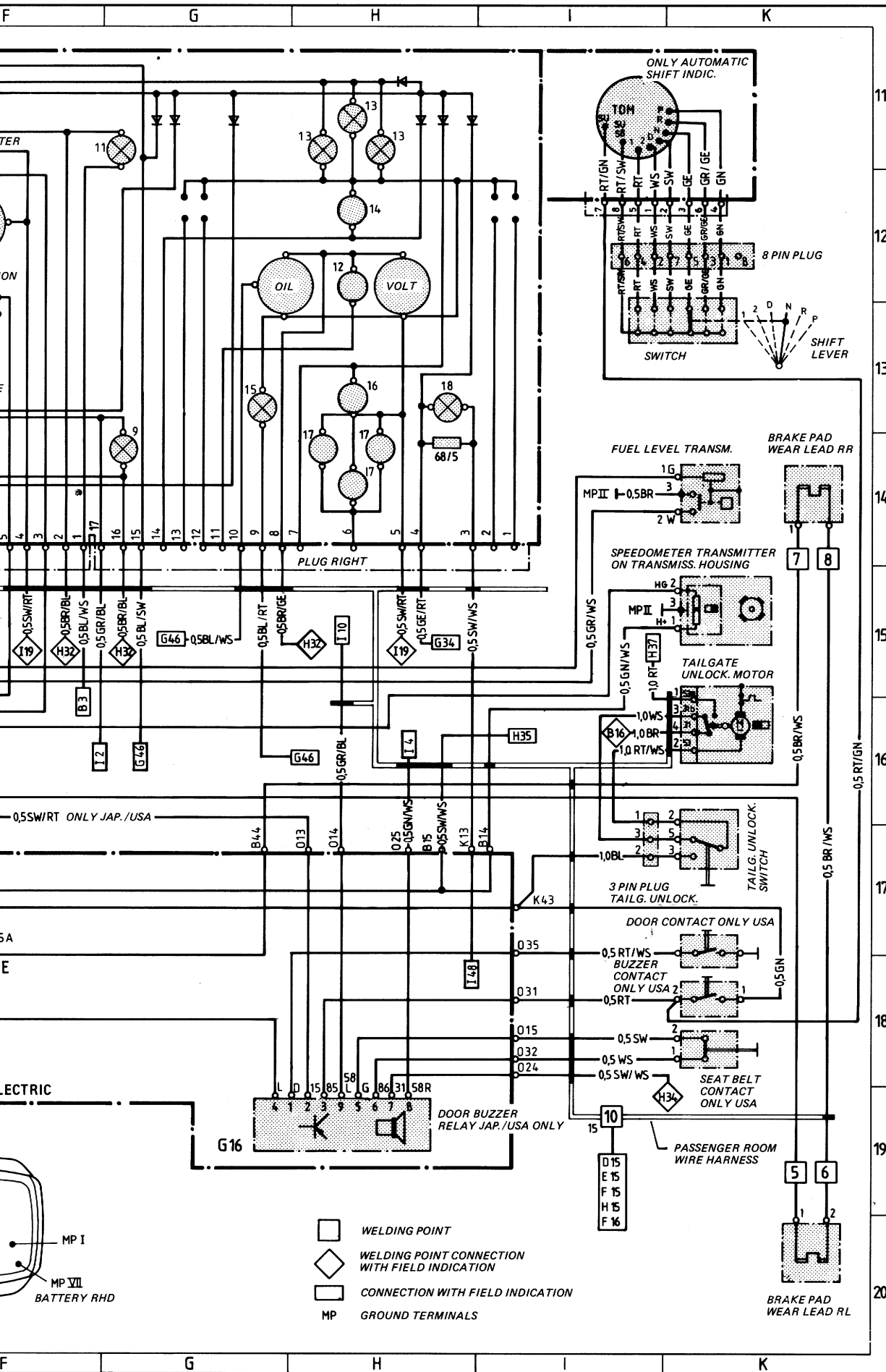

Wiring Diagram Type 944, 944 turbo Model 85/2 page 5

HEATING, A/C, VENTILATION, ELECTR.
SEATS, WIPER AND WASHER SYSTEM

Attention!

Only for vehicles up to vehicle identification No.

**94 FN401638
95 FN10 0122**

**94 FN45 1912
95 FN15 0106**

Wiring Diagram Type 944, 944 turbo Model 85/2 page 5

HEATING, A/C, VENTILATION, ELECTR. SEATS, WIPER AND WASHER SYSTEM

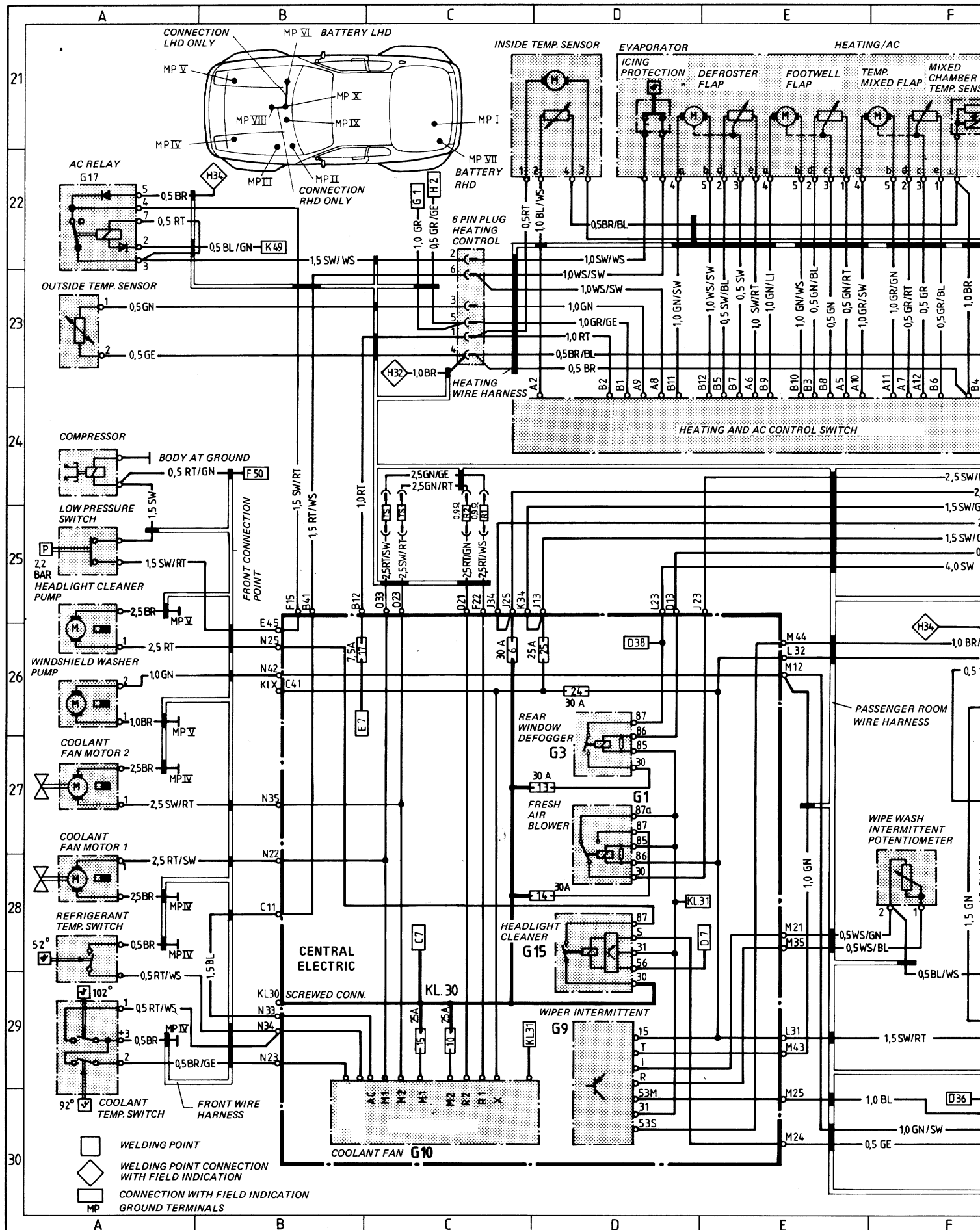

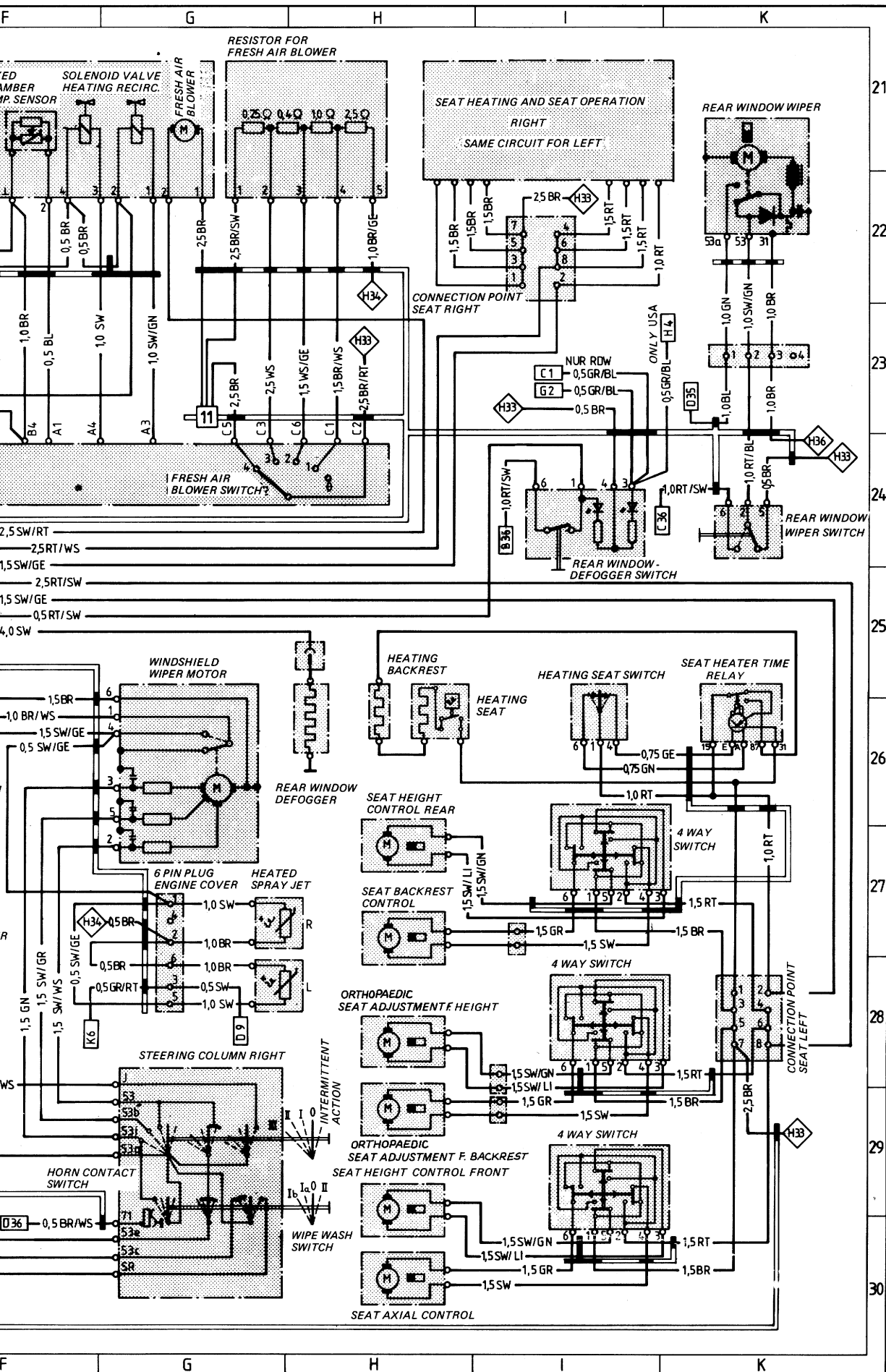

Wiring Diagram Type 944, 944 turbo Model 85/2 page 6

HORNS, MIRRORS, WINDOW LIFTERS,
ALARM SYSTEM, TILTING ROOF

Attention!

Only for vehicles up to vehicle identification No.

**94 FN 40 1638
95 FN 10 0122**

**94 FN 45 1912
95 FN 15 0106**

HORNS, MIRRORS, WINDOW LIFTERS, ALARM SYSTEM, TILTING ROOF

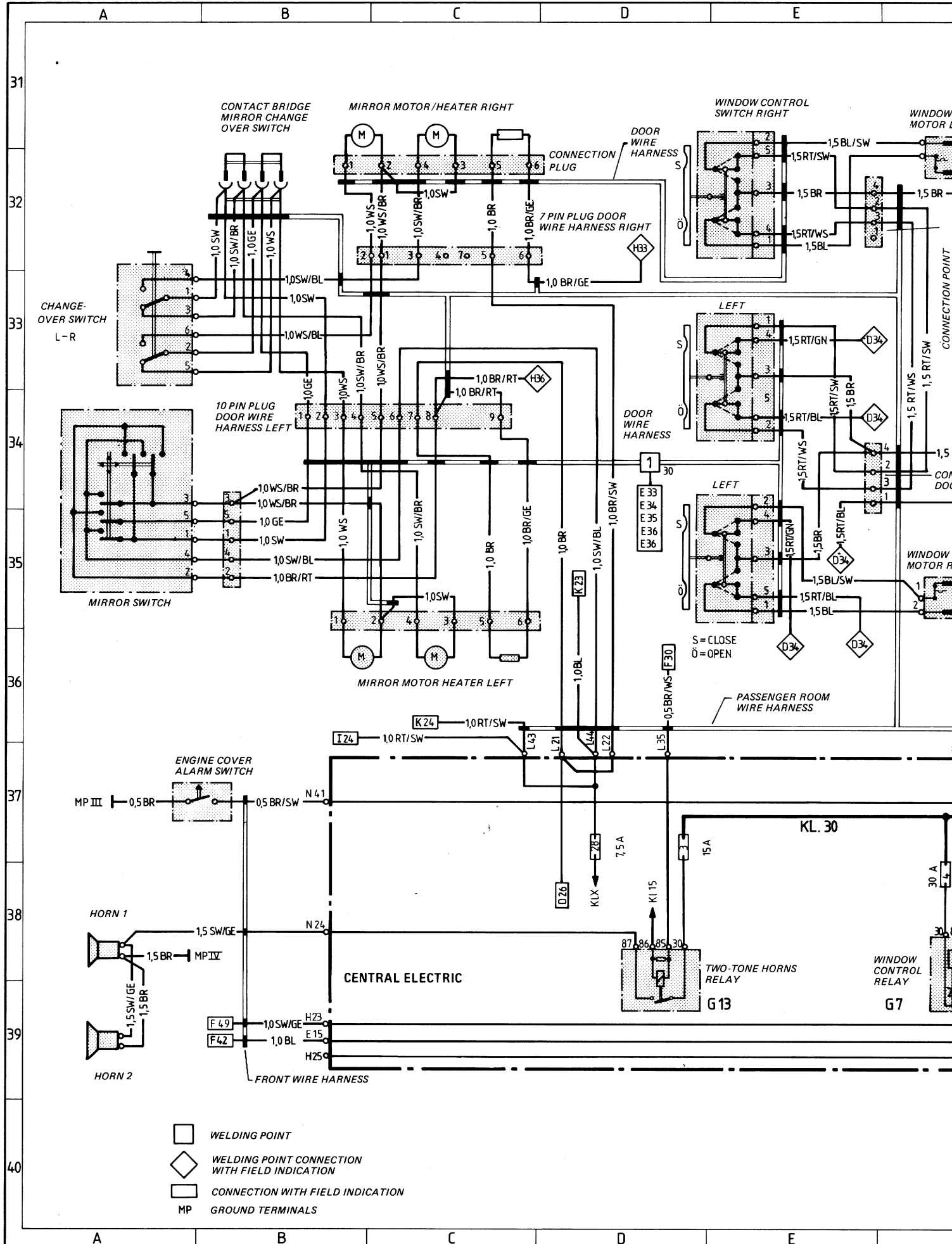

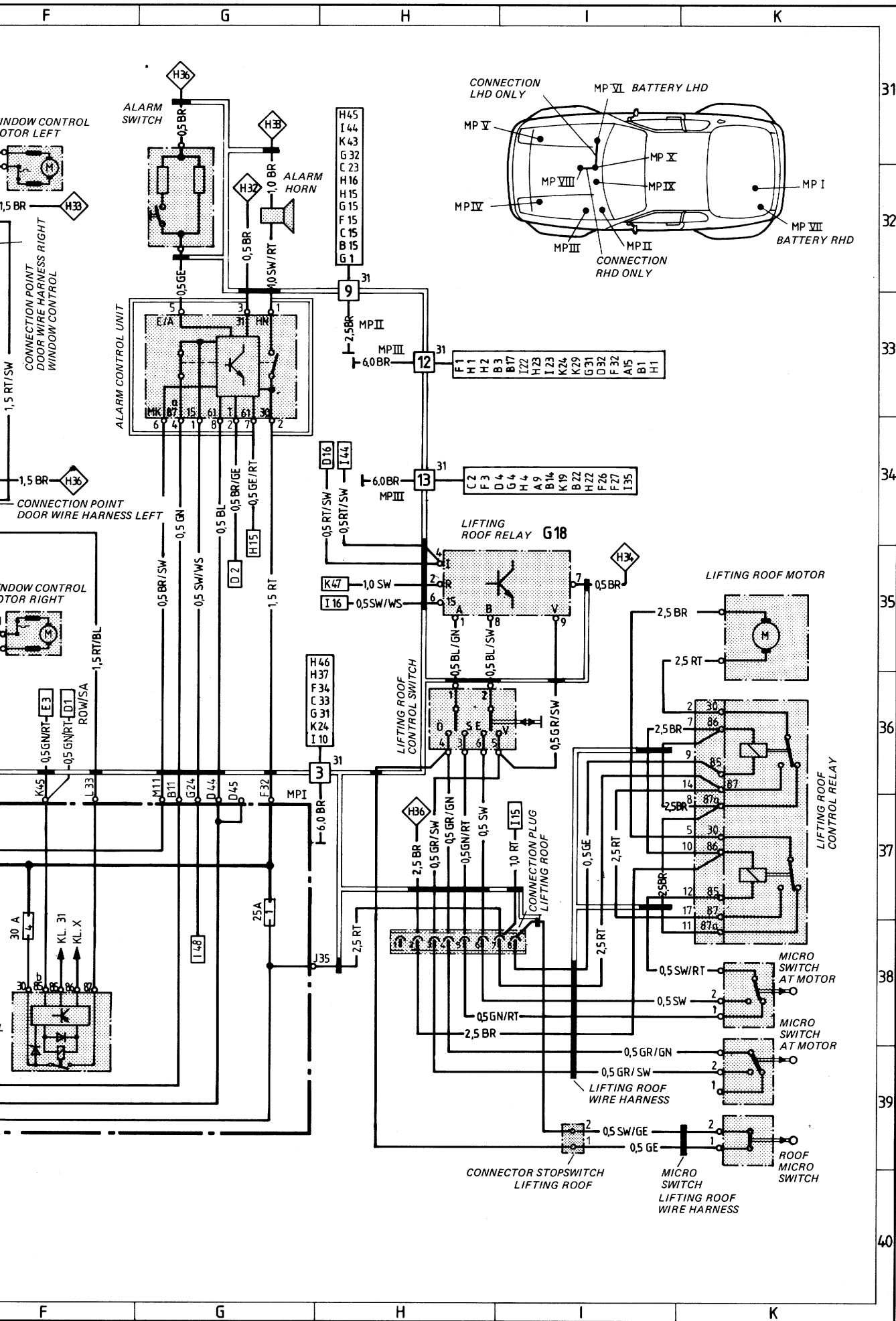

Wiring Diagram Type 944, 944 turbo
Model 85/2 page 7

ENGINE COMPARTMENT

Attention!

Only for vehicles up to vehicle identification No.

94 FN 40 1638

94 FN 45 1912

95 FN 10 0122

95 FN 15 0106

Wiring Diagram Type 944, 944 turbo Model 85/2 page

ENGINE COMPARTMENT

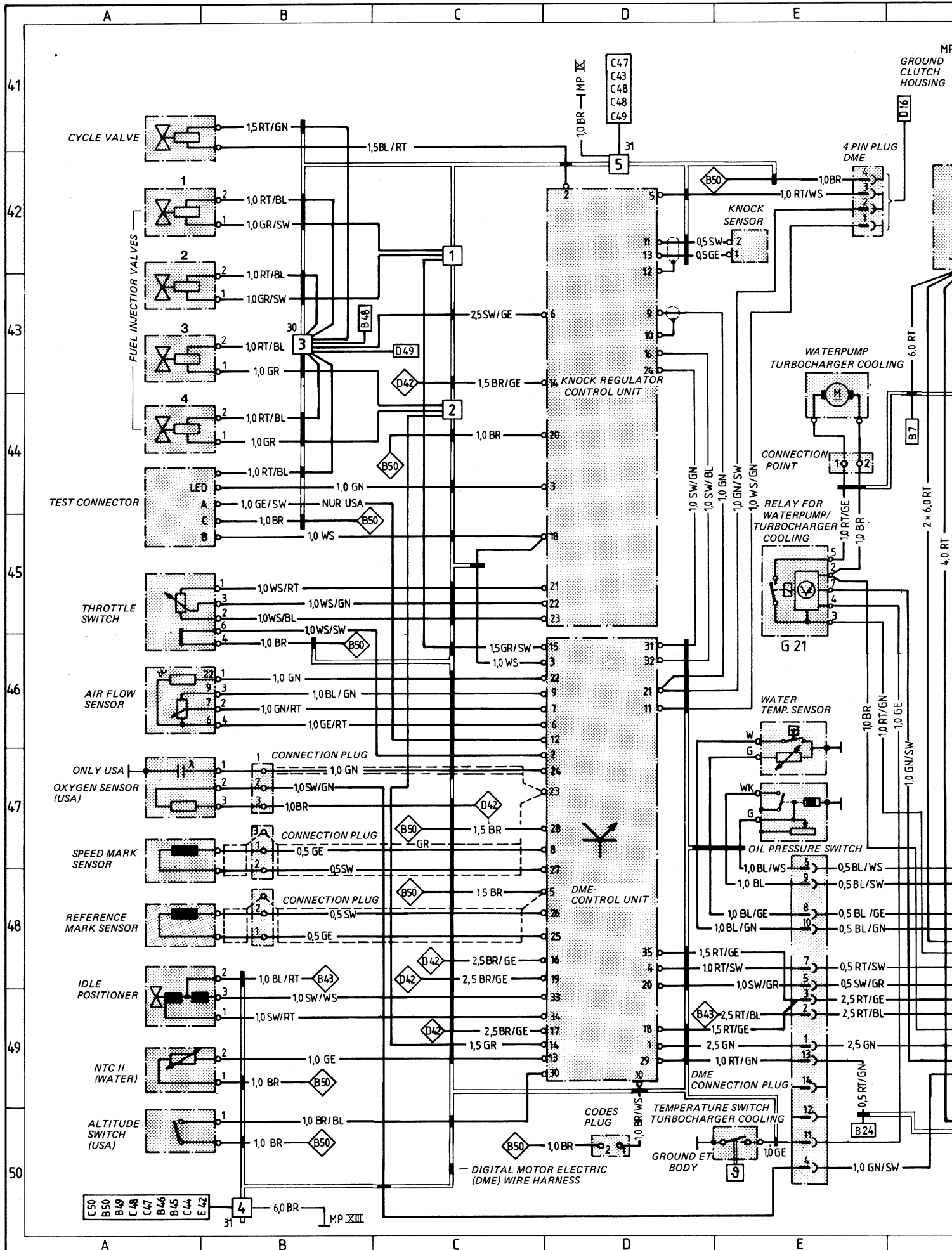

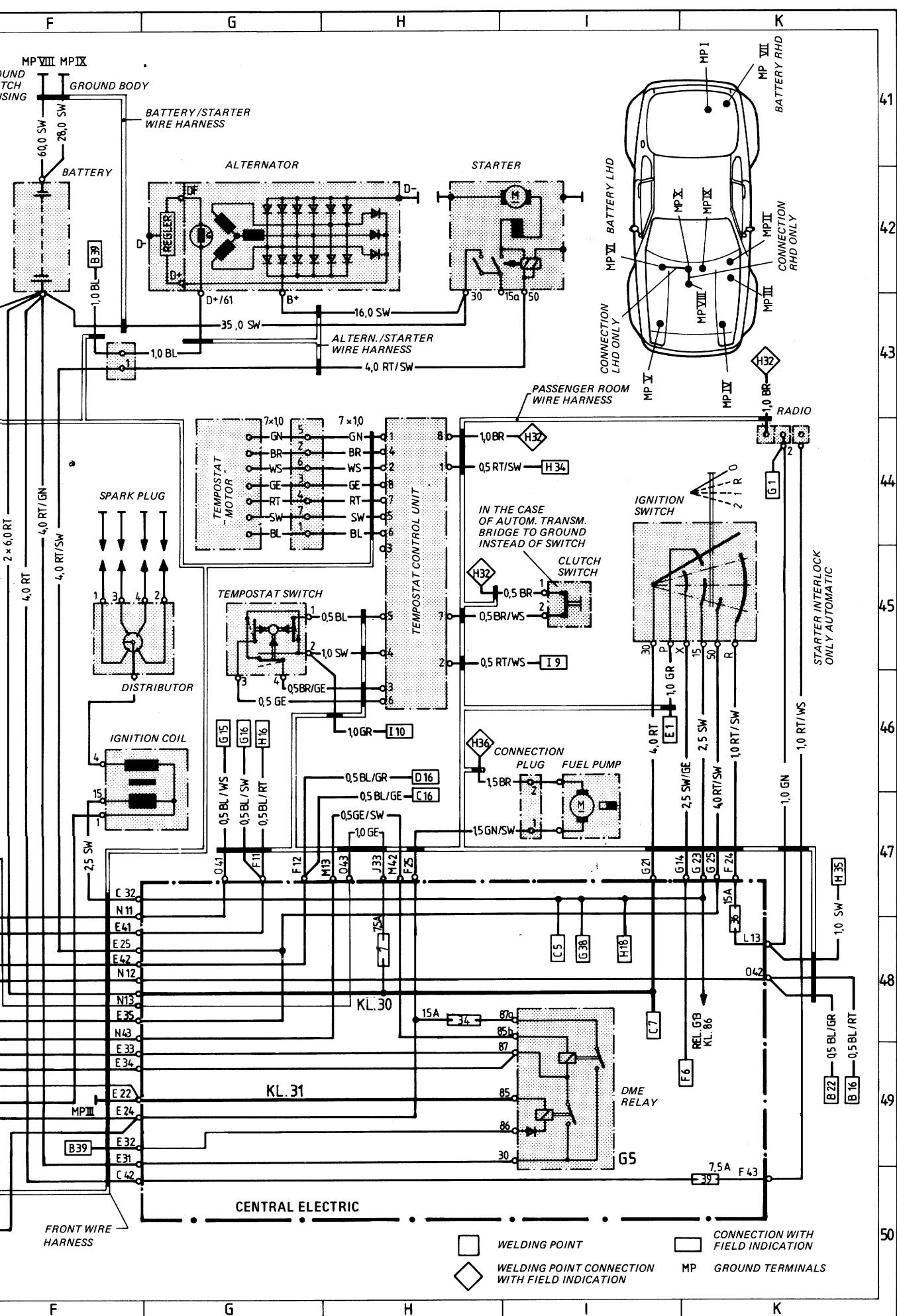

Wiring Diagram Type 944, 944 turbo
Model 85/2 page 8

CENTRAL-ELECTRICS BOX

Attention!

Only for vehicles up to vehicle identification No.

94 FN 401638
95 FN 100122

94 FN 45 1912
95 FN 15 0106

CENTRAL-ELECTRICS BOX

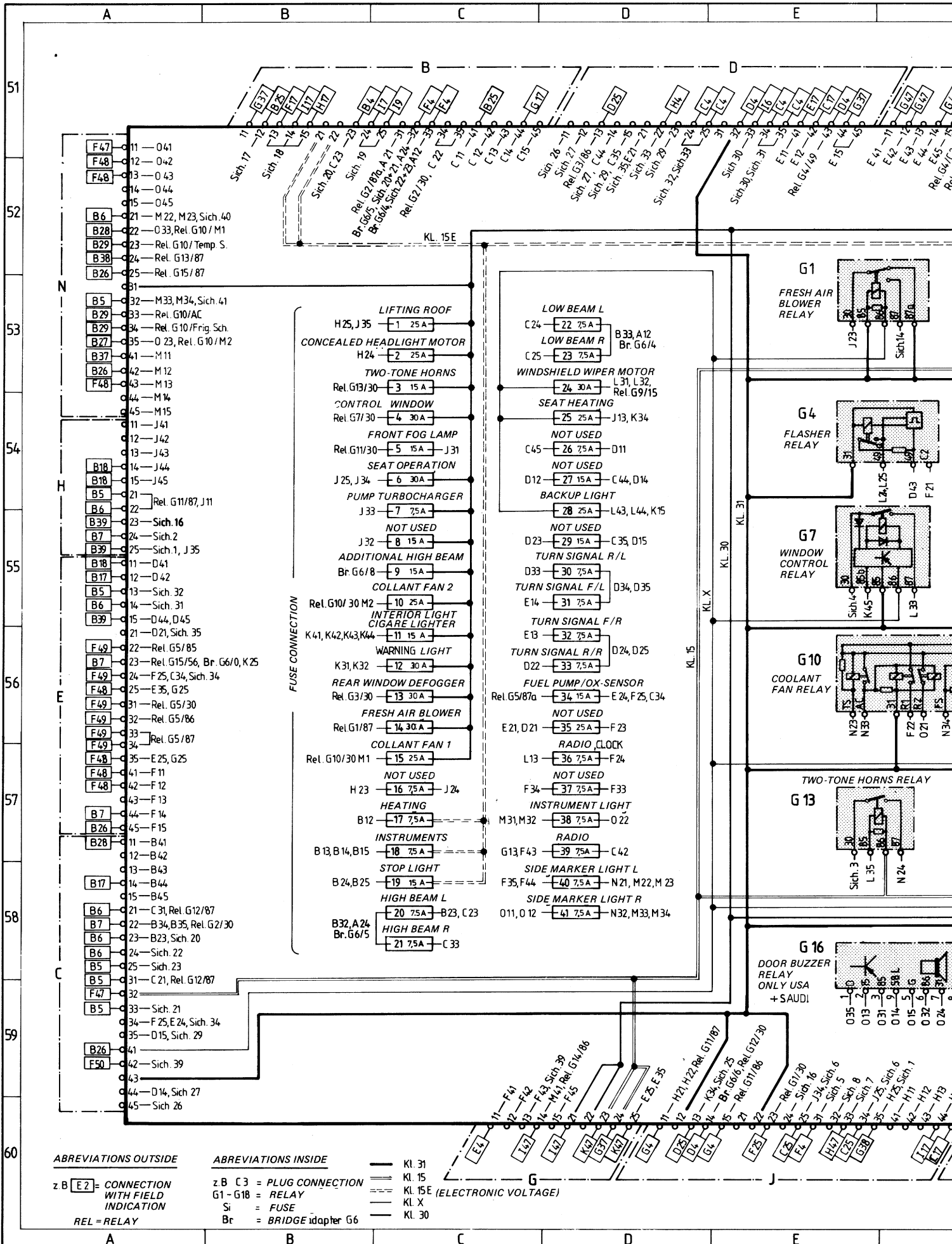

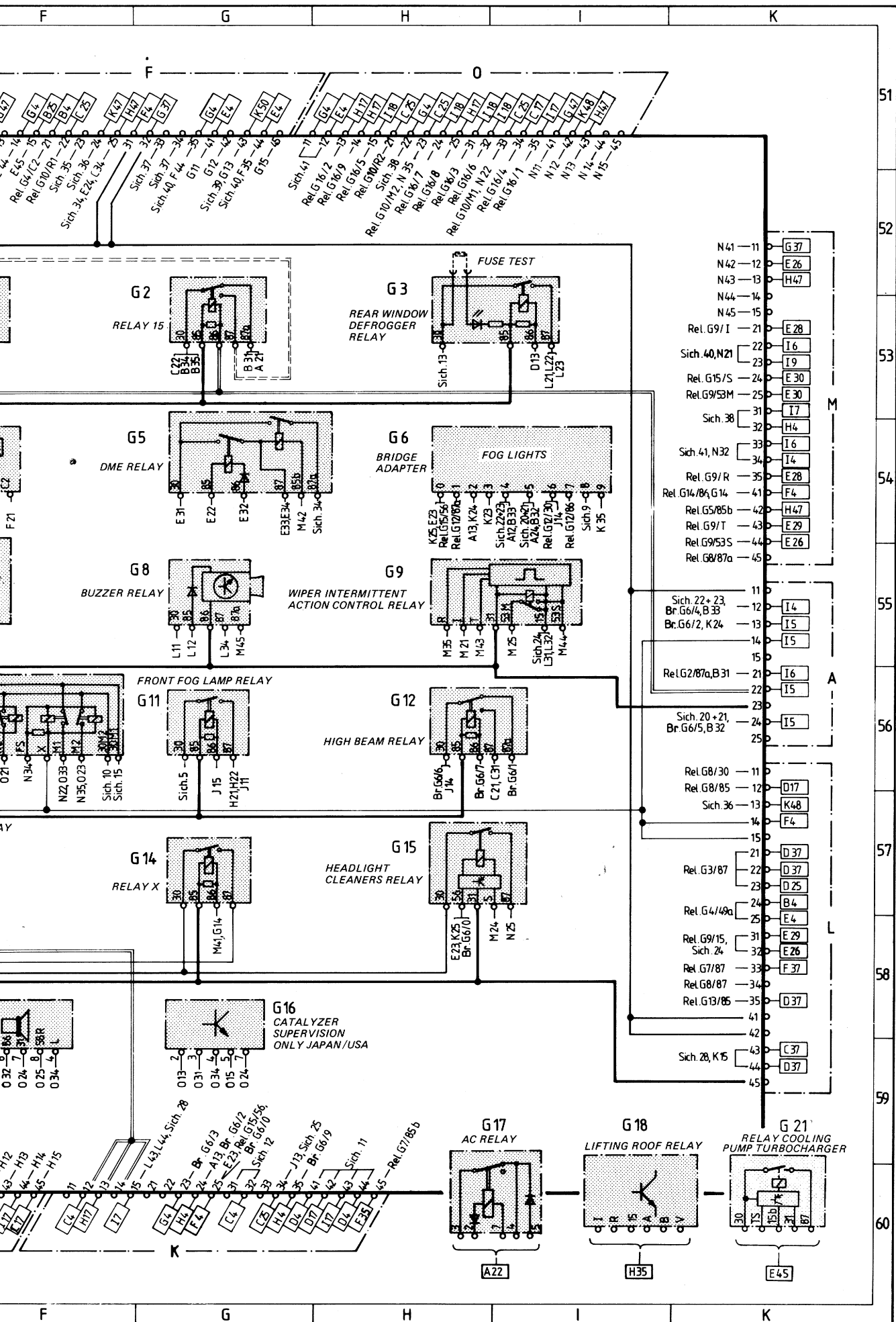

Wiring Diagram Type 944, 944 turbo Model 85/2

SHEET 1	LIGHTING ROW/SA
SHEET 2	LIGHTING USA
SHEET 3	INSTRUMENT CLUSTER AND SENSORS ROW
SHEET 4	INSTRUMENT CLUSTER AND SENSORS USA/SA
SHEET 5	HEATING, A/C, VENTILATION, ELECTR. SEATS, WIPER AND WASHER SYSTEM
SHEET 6	HORNS, MIRRORS, WINDOW LIFTERS, ALARM SYSTEM, TILTING ROOF
SHEET 7	ENGINE COMPARTMENT
SHEET 8	CENTRAL-ELECTRICS BOX

Wiring Diagram Type 944, 944 turbo Model 85/2

The 944, 85/2 model, is being accompanied by a new generation of wiring diagrams.

The wiring diagram consists of eight individual wiring diagrams. These are divided into coordinate fields.

Each individual wiring diagram contains a part of the central-electrics box in a dash-dotted frame.

This part of the central-electrics box shows all the lines and relays necessary for the individual wiring diagram.

The earth/ground points are identified by "MP" and their location is shown in a vehicle diagram.

The 20-pin connectors on the central-electrics box are new. They are clipped together out of 5 parts.

Part 1, with the moulded-on fastening lug, is the "starting element".

Parts 2, 3 and 4 are "module elements".

Parts 1 to 4 are identified by the numbers 1 5.

Part 5 is a "coding element".

The designations of the plug connections in the wiring diagram of the central-electrics box refer to the "starting element" from, for example, B 11 15, and to the first module element from B 21 25.

Wiring Diagram Type 944, 944 turbo Model 85/2 page 1

LIGHTING ROW/SA

Wiring Diagram Type 944, 944 turbo Model 85/2 page 1

LIGHTING ROW/SA

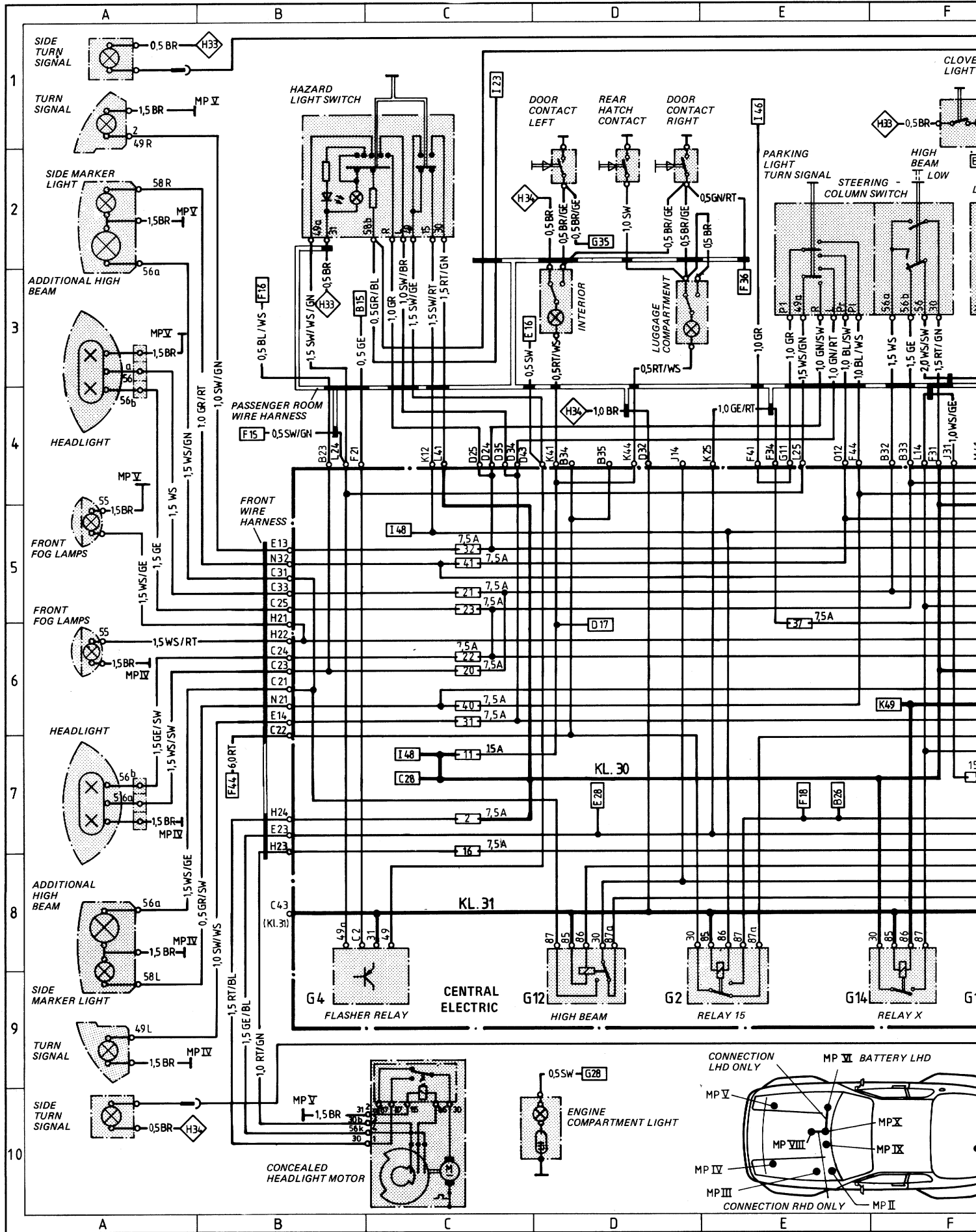

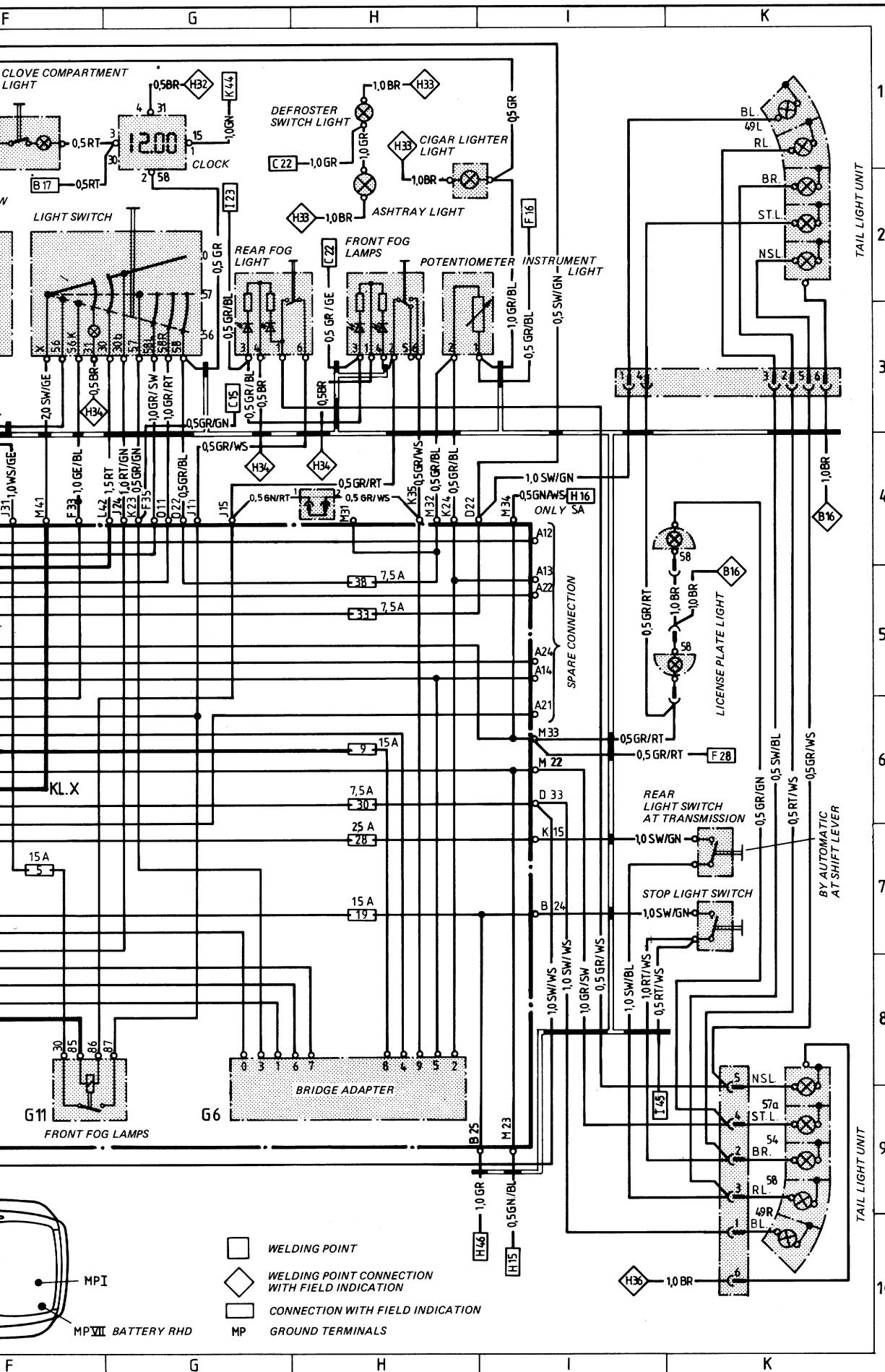

Wiring Diagram Type 944, 944 turbo Model 85/2 page 2

LIGHTING USA

Wiring Diagram Type 944, 944 turbo Model 85/2 page 2

LIGHTING USA

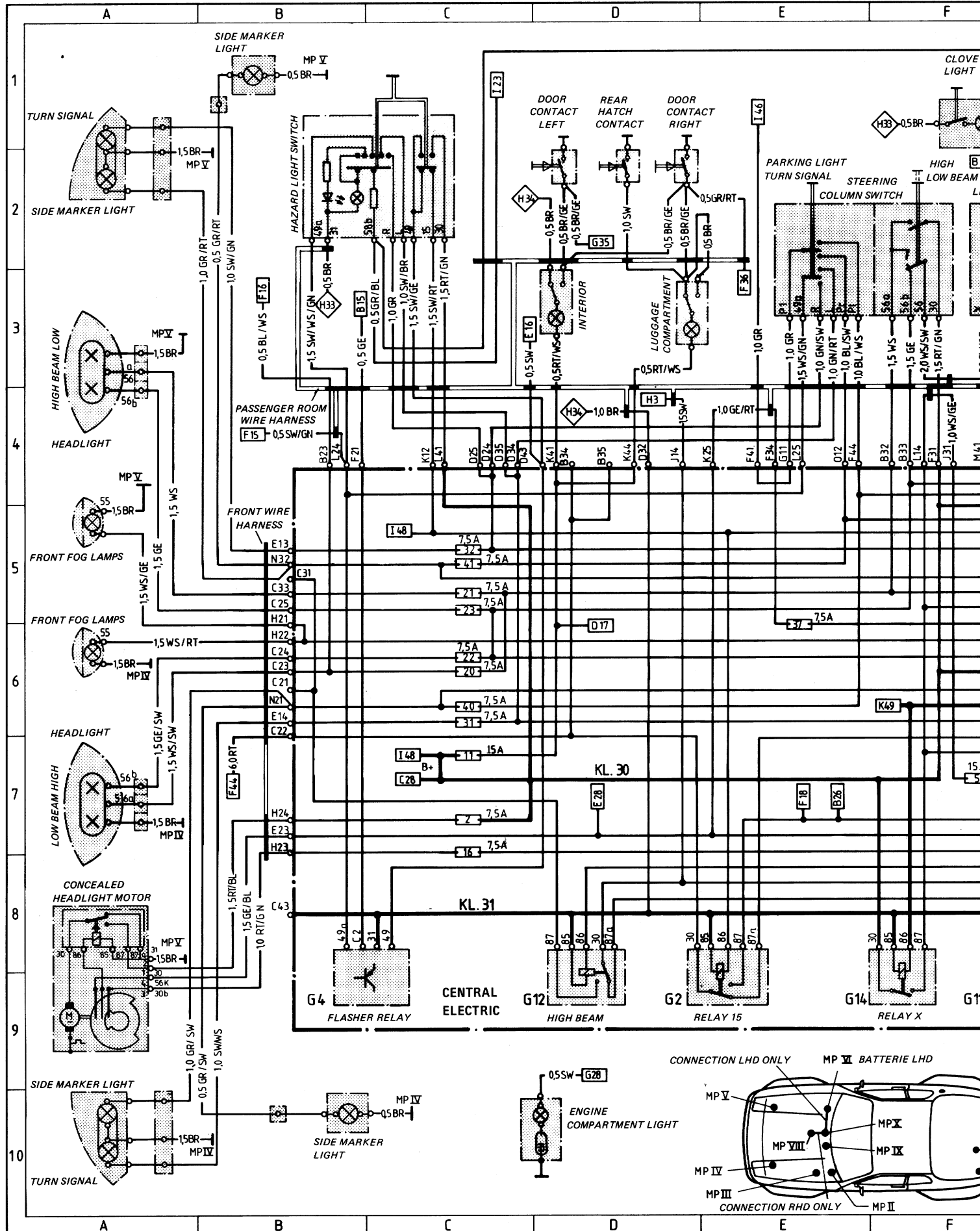

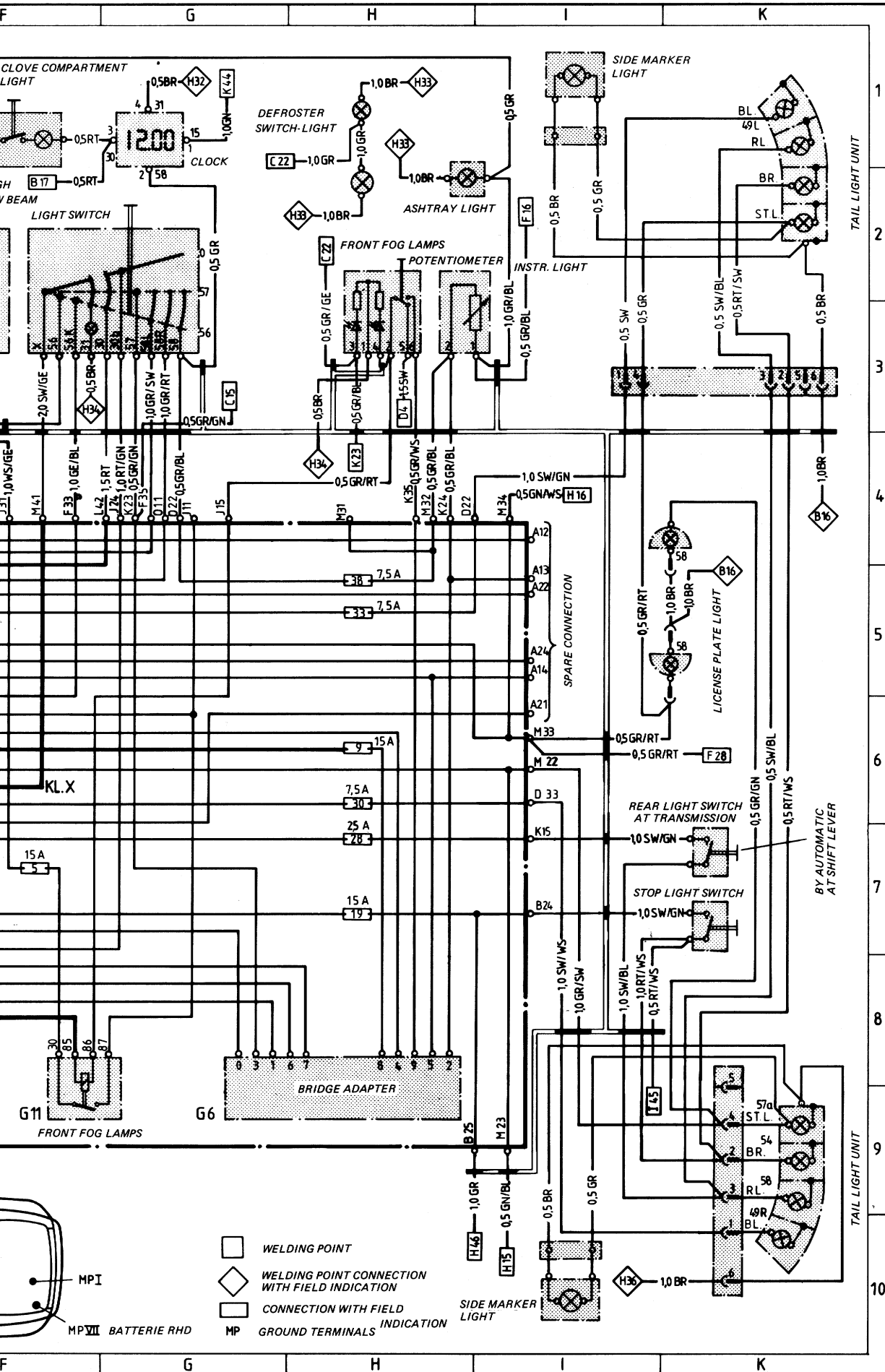

Wiring Diagram Type 944, 944 turbo Model 85/2 page 3

INSTRUMENT CLUSTER AND SENSORS
ROW

Wiring Diagram Type 944, 944 turbo Model 85/2 page 3

INSTRUMENT CLUSTER AND SENSORS ROW

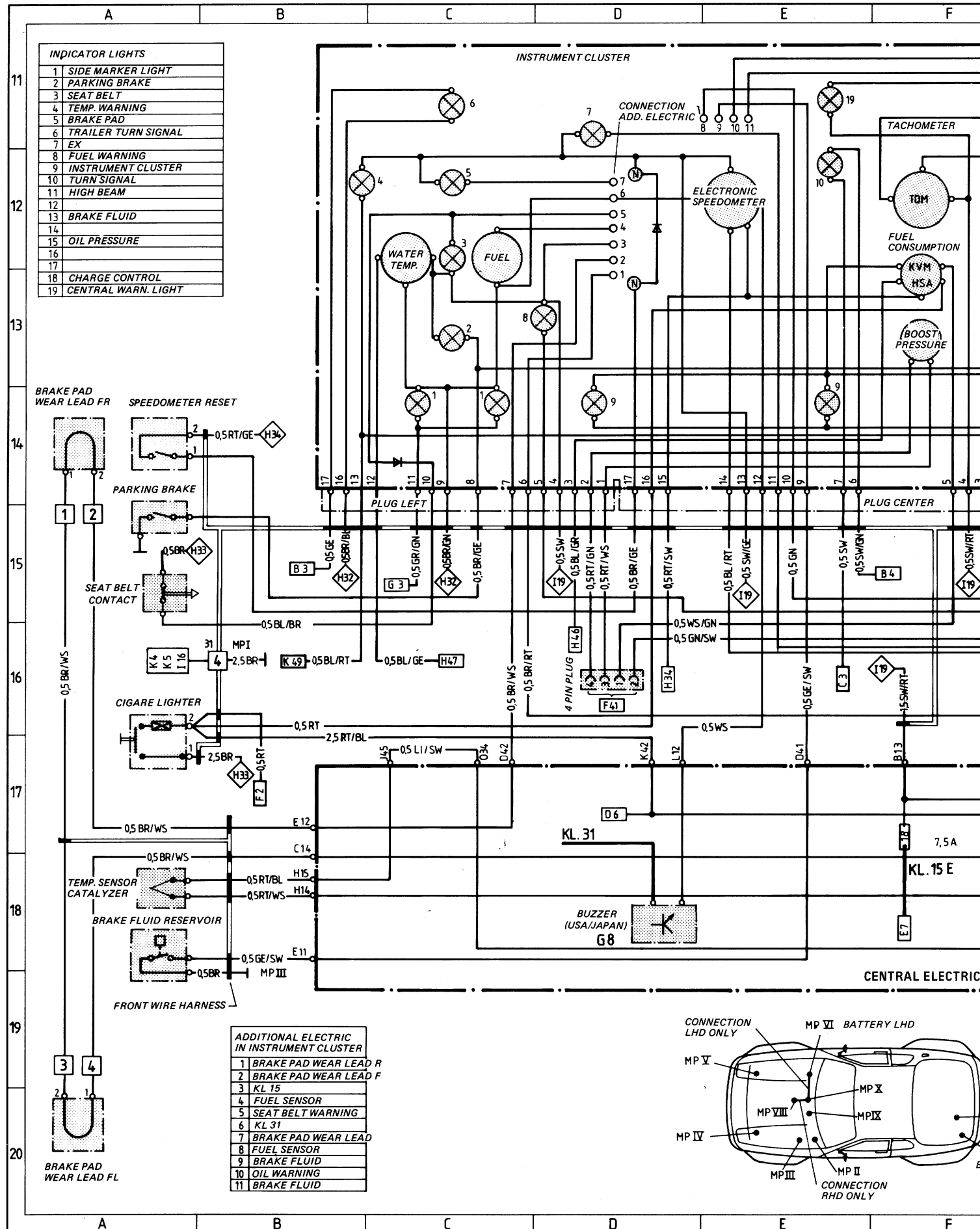

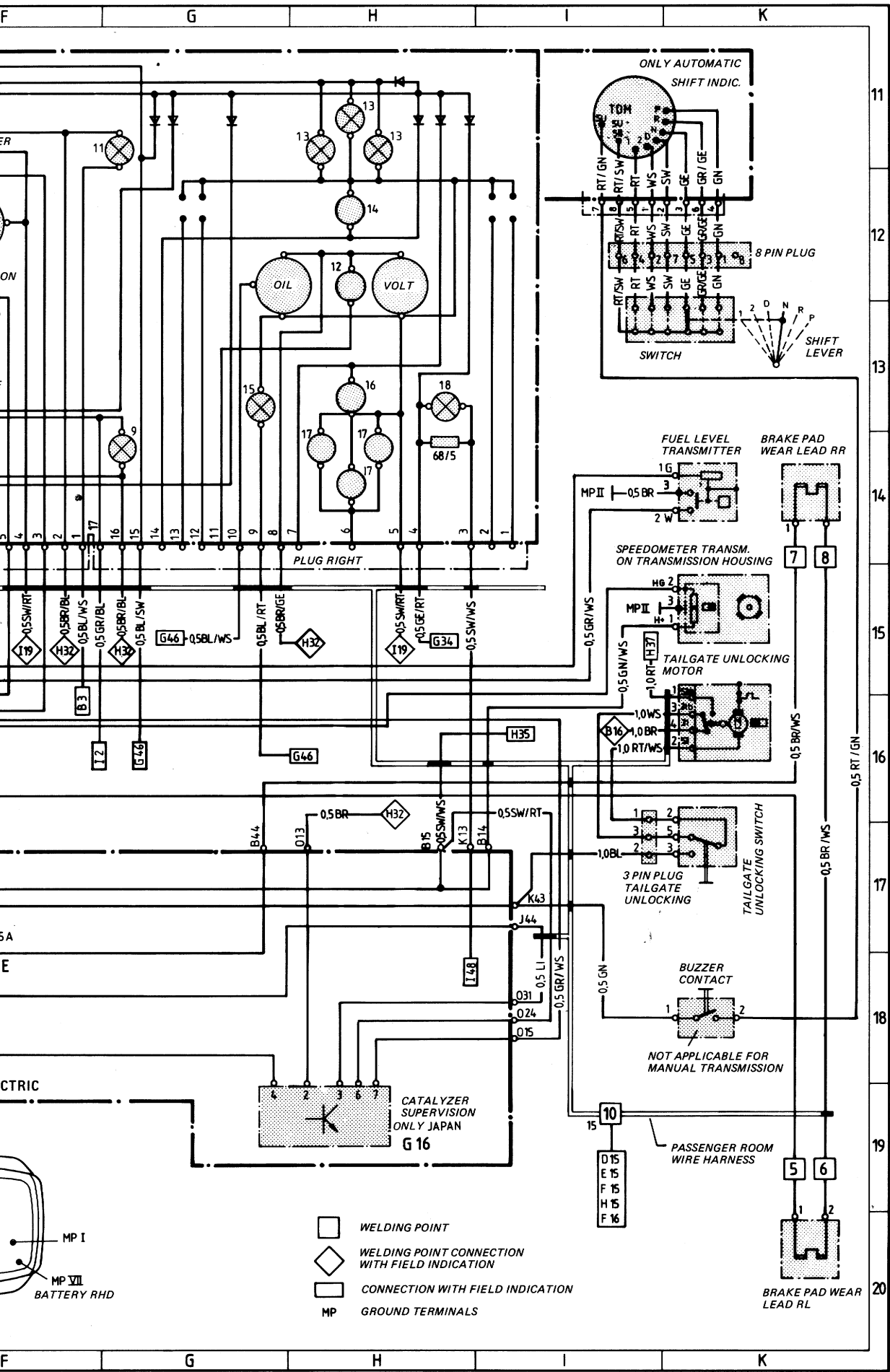

Wiring Diagram Type 944, 944 turbo Model 85/2 page 4

INSTRUMENT CLUSTER AND SENSORS
USA/SA

Wiring Diagram Type 944, 944 turbo Model 85/2 page 4

INSTRUMENT CLUSTER AND SENSORS USA/SA

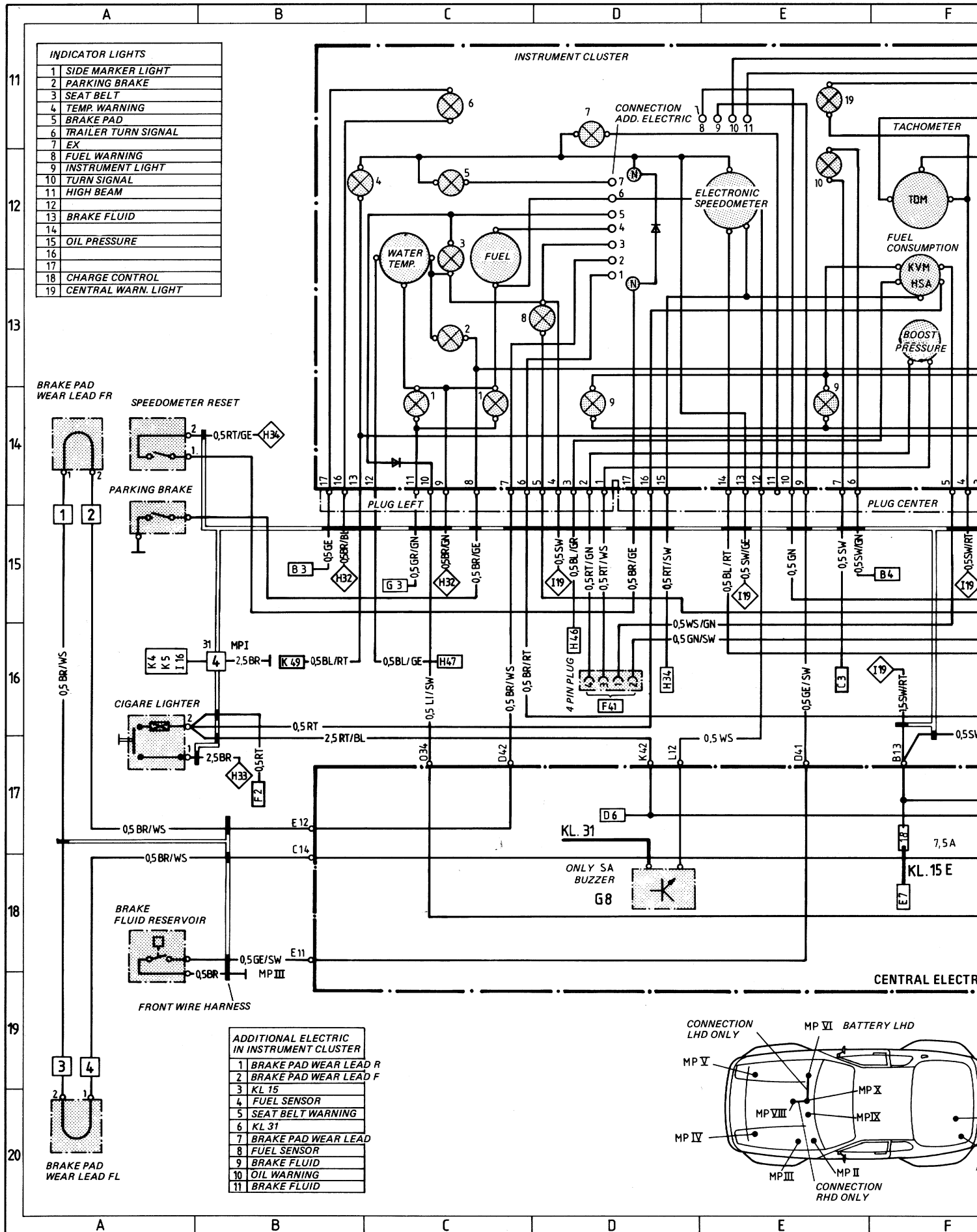

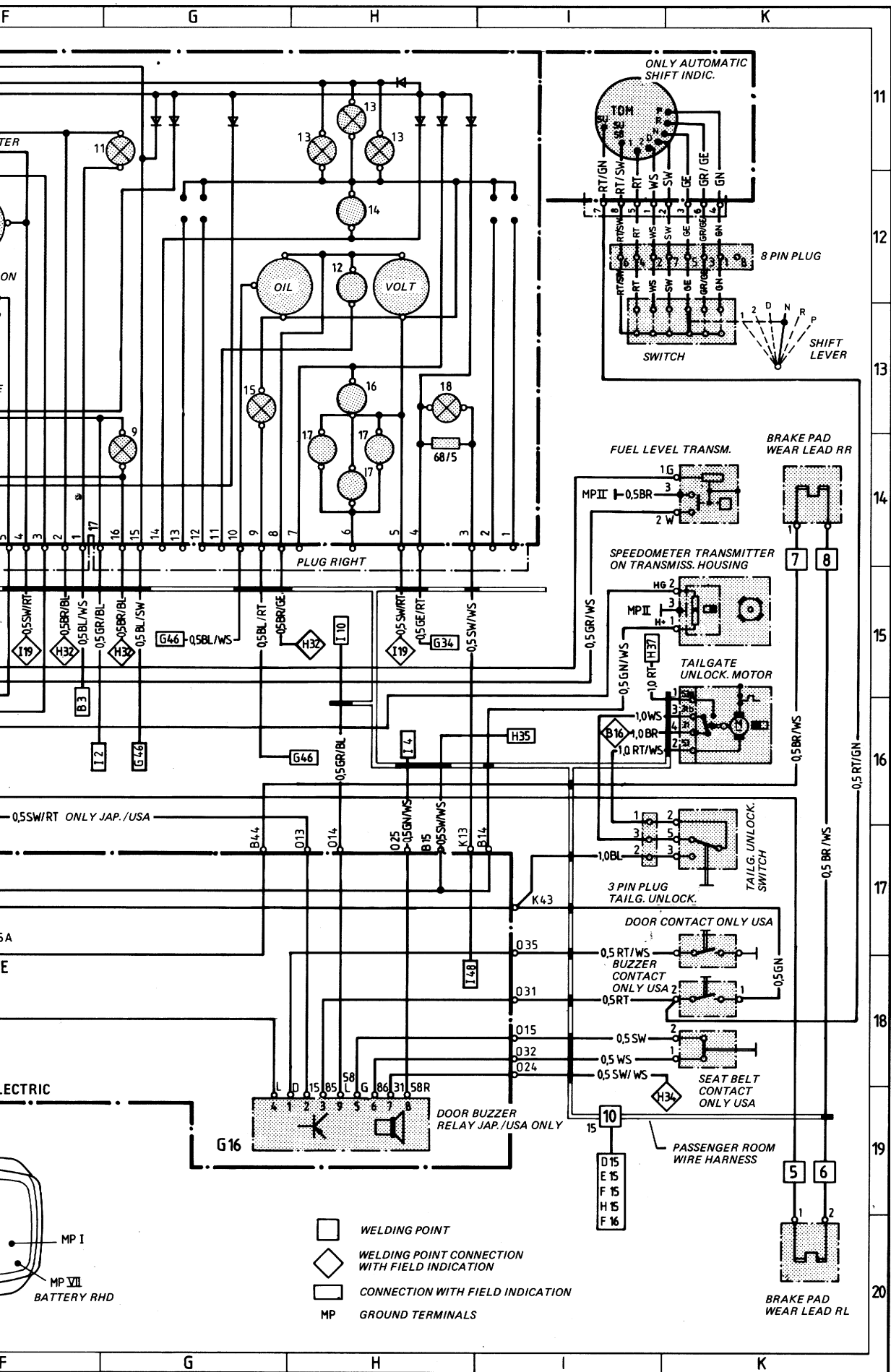

Wiring Diagram Type 944, 944 turbo Model 85/2 page 5

HEATING, A/C, VENTILATION, ELECTR.
SEATS, WIPER AND WASHER SYSTEM

Wiring Diagram Type 944, 944 turbo Model 85/2 page 5

HEATING, A/C, VENTILATION, ELECTR. SEATS, WIPER AND WASHER SYSTEM

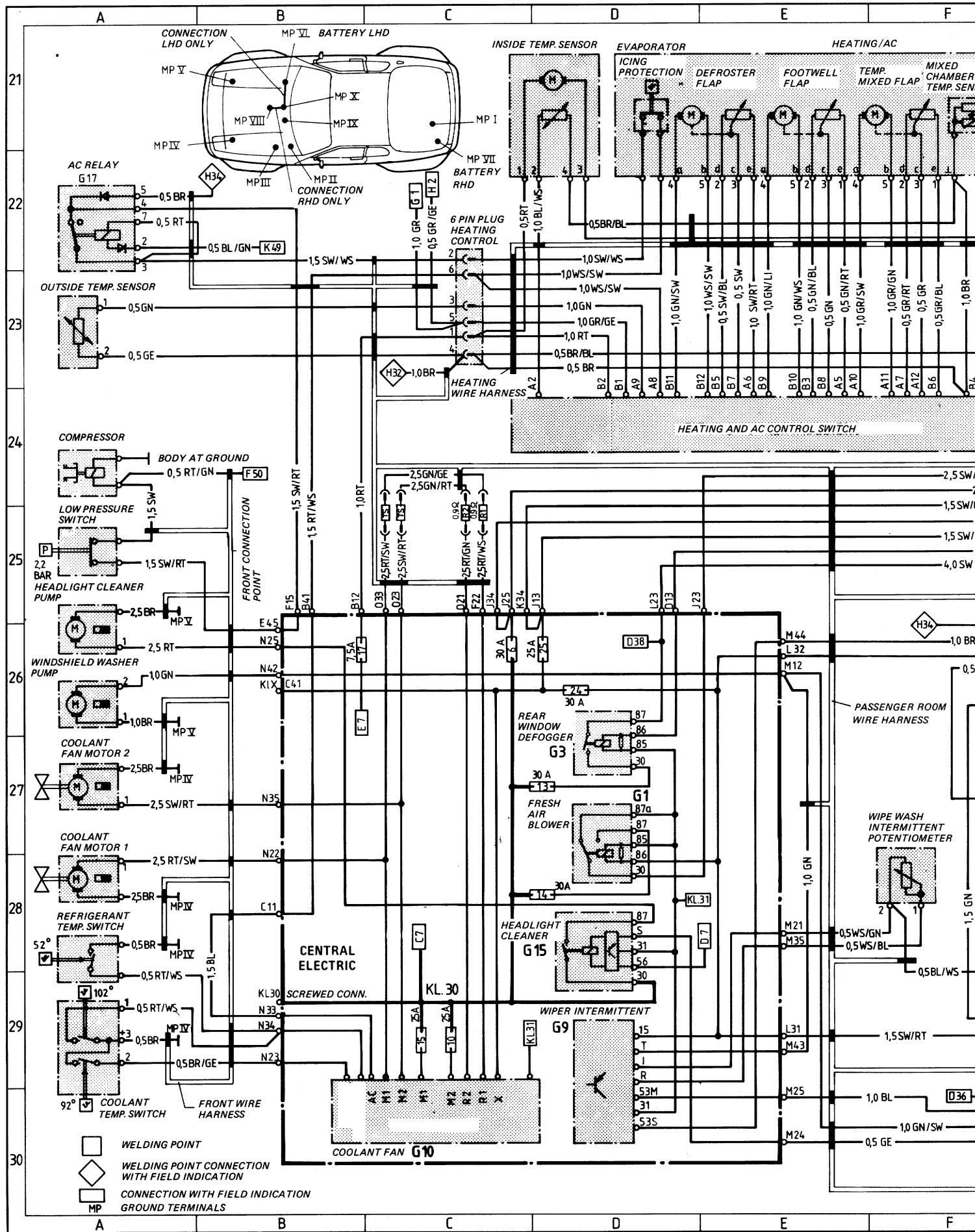

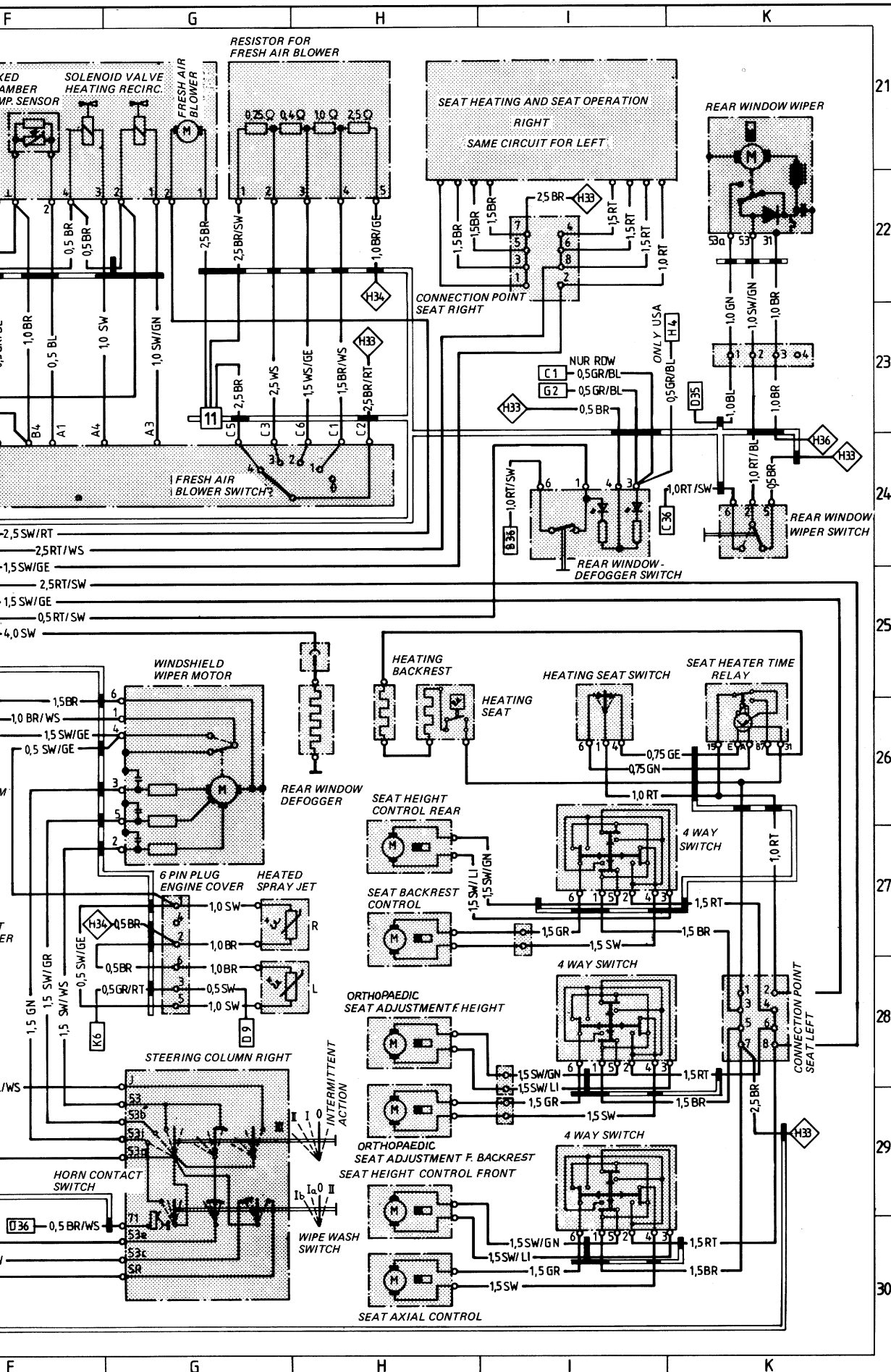

Wiring Diagram Type 944, 944 turbo Model 85/2 page 6

HORNS, MIRRORS, WINDOW LIFTERS,
ALARM SYSTEM, TILTING ROOF

Wiring Diagram Type 944, 944 turbo Model 85/2 page 6

HORNS, MIRRORS, WINDOW LIFTERS, ALARM SYSTEM, TILTING ROOF

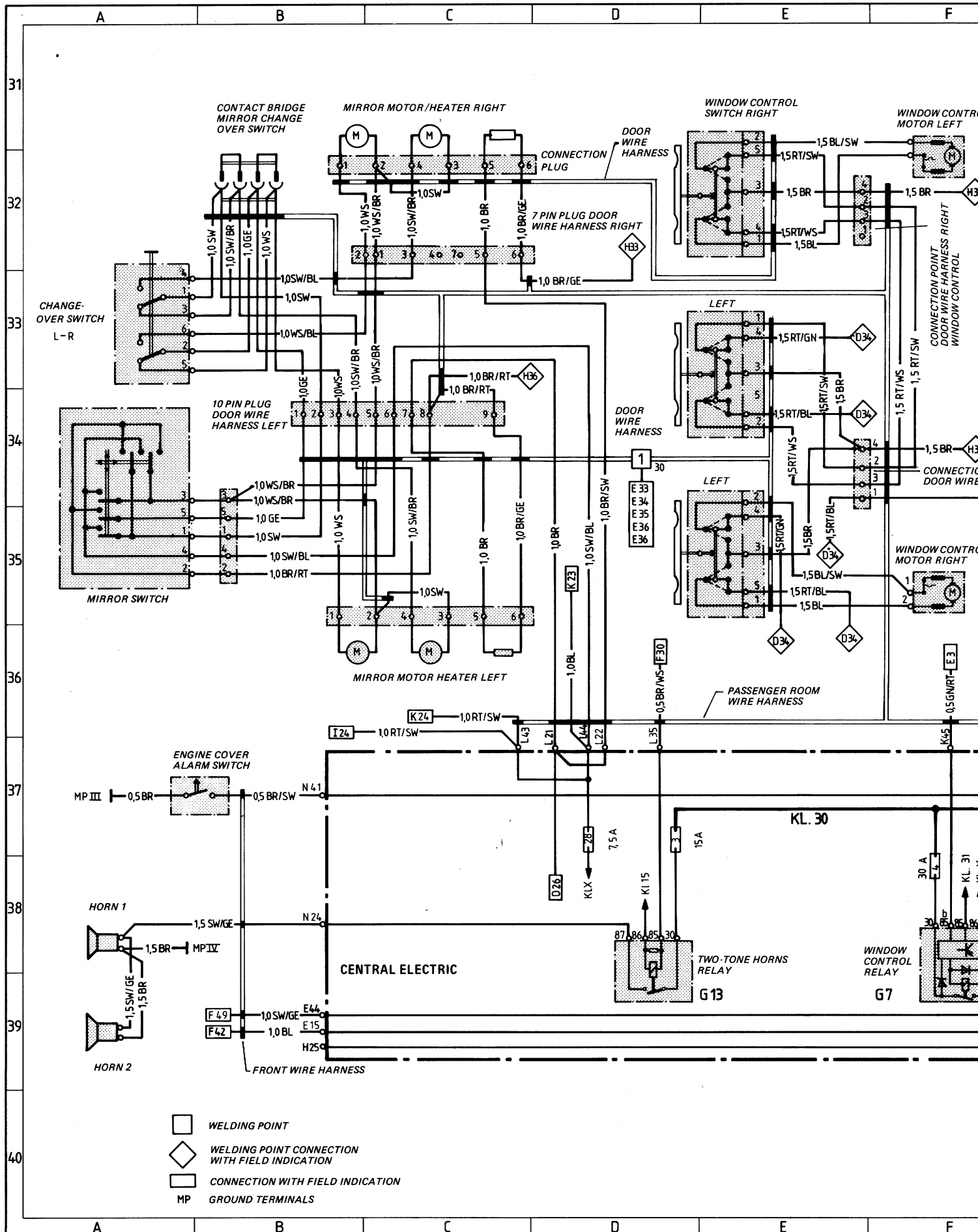

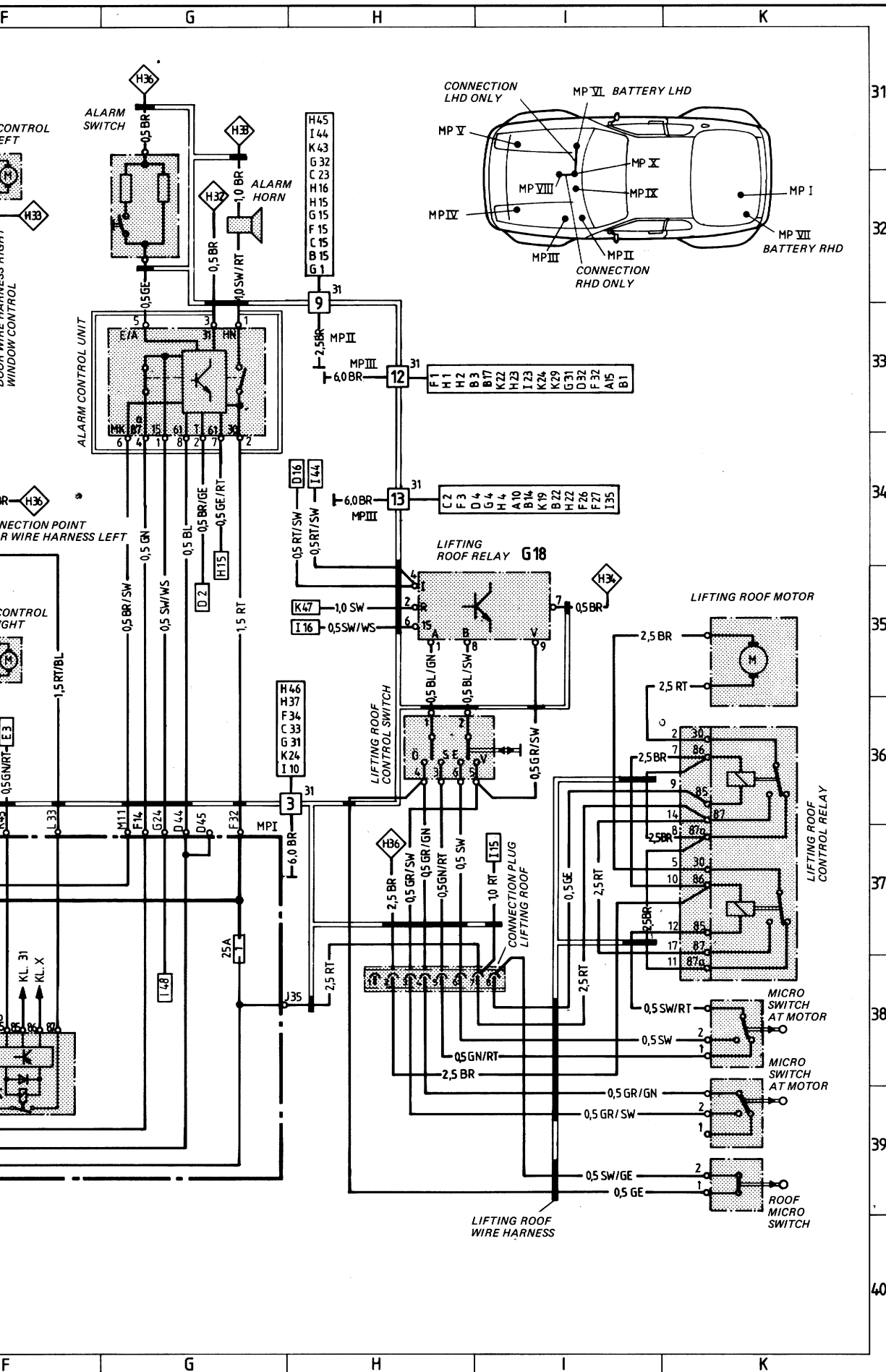

Wiring Diagram Type 944, 944 turbo Model 85/2 page 7

ENGINE COMPARTMENT

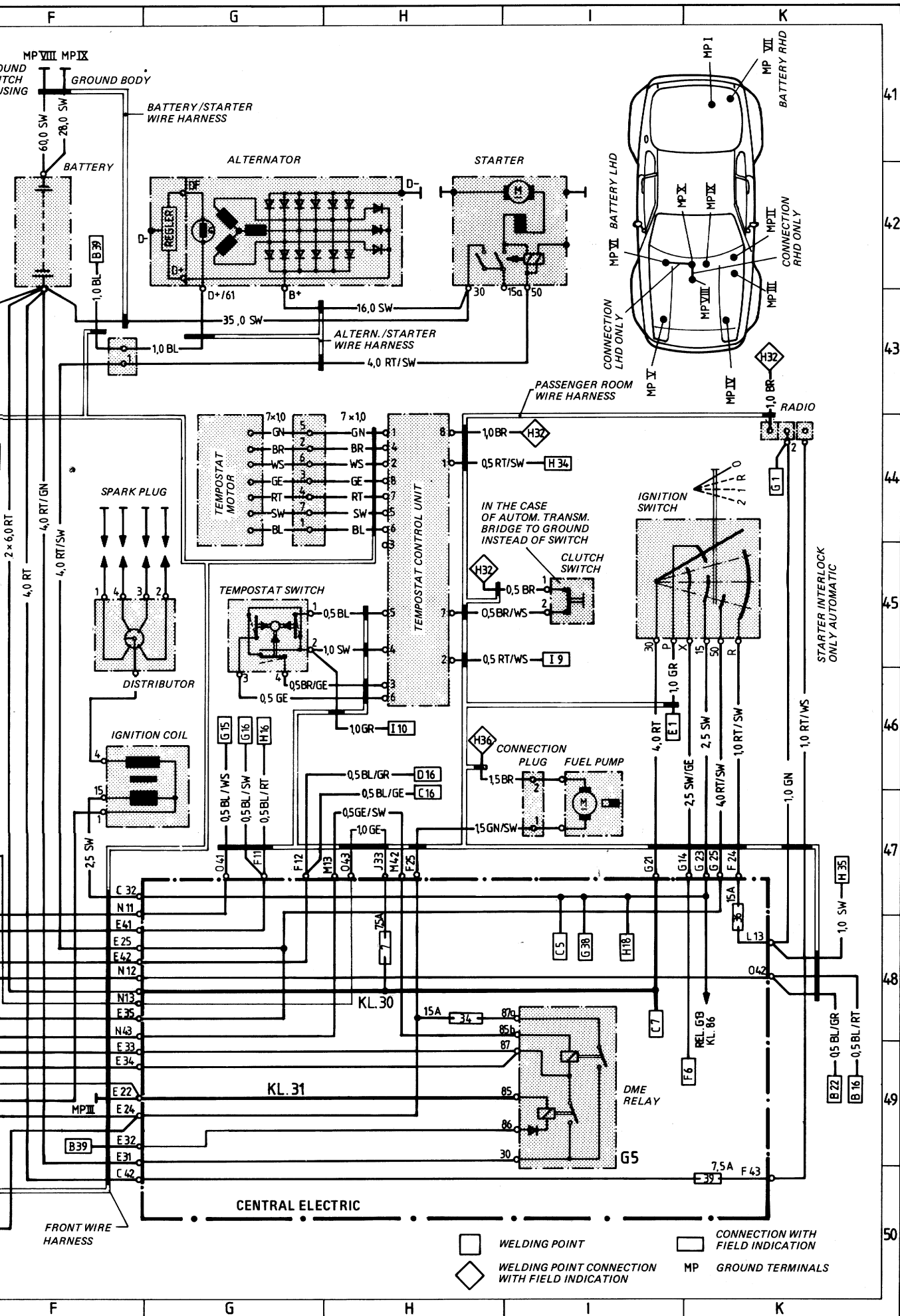

Wiring Diagram Type 944, 944 turbo Model 85/2 page 8

CENTRAL-ELECTRICS BOX

CENTRAL-ELECTRICS BOX

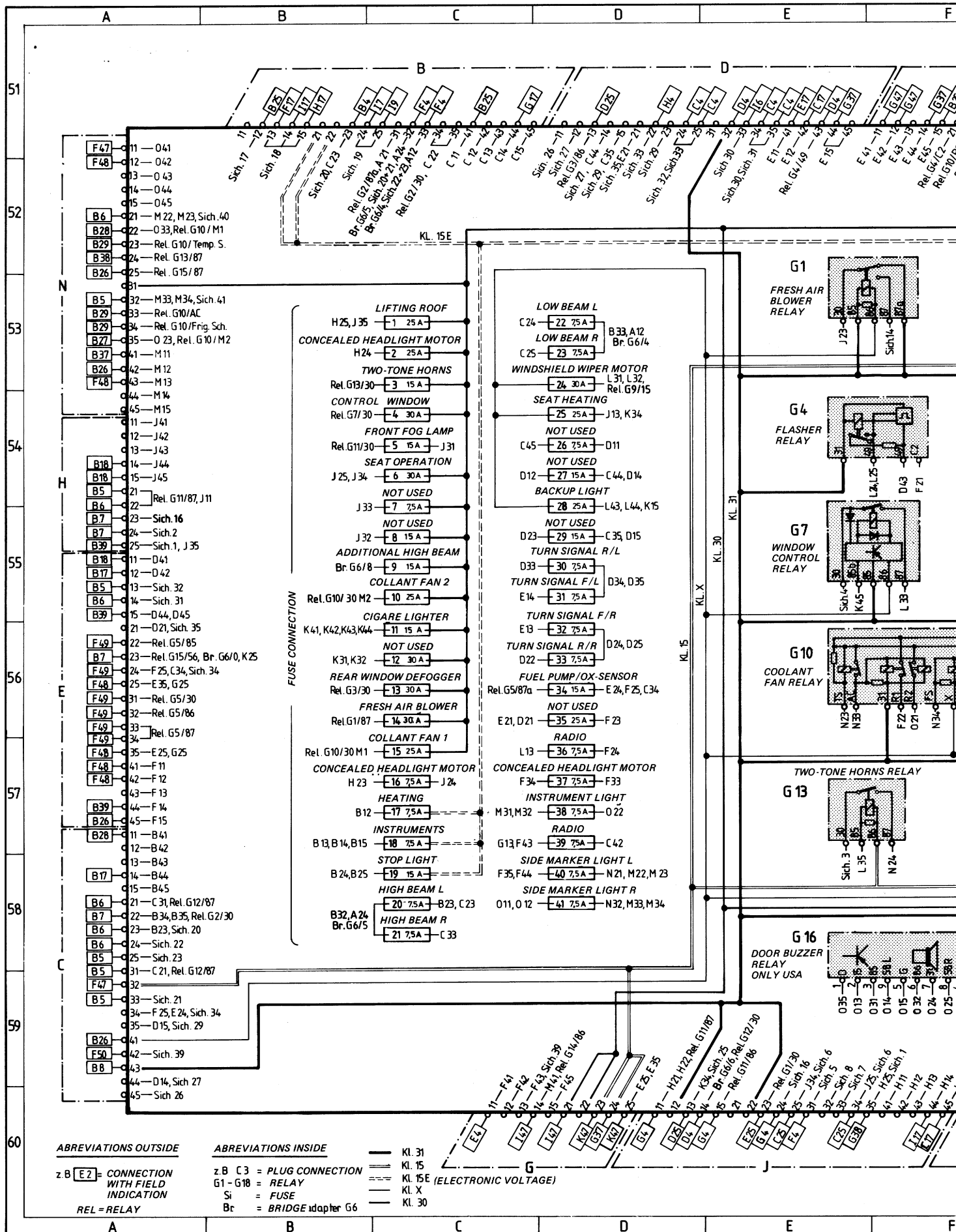

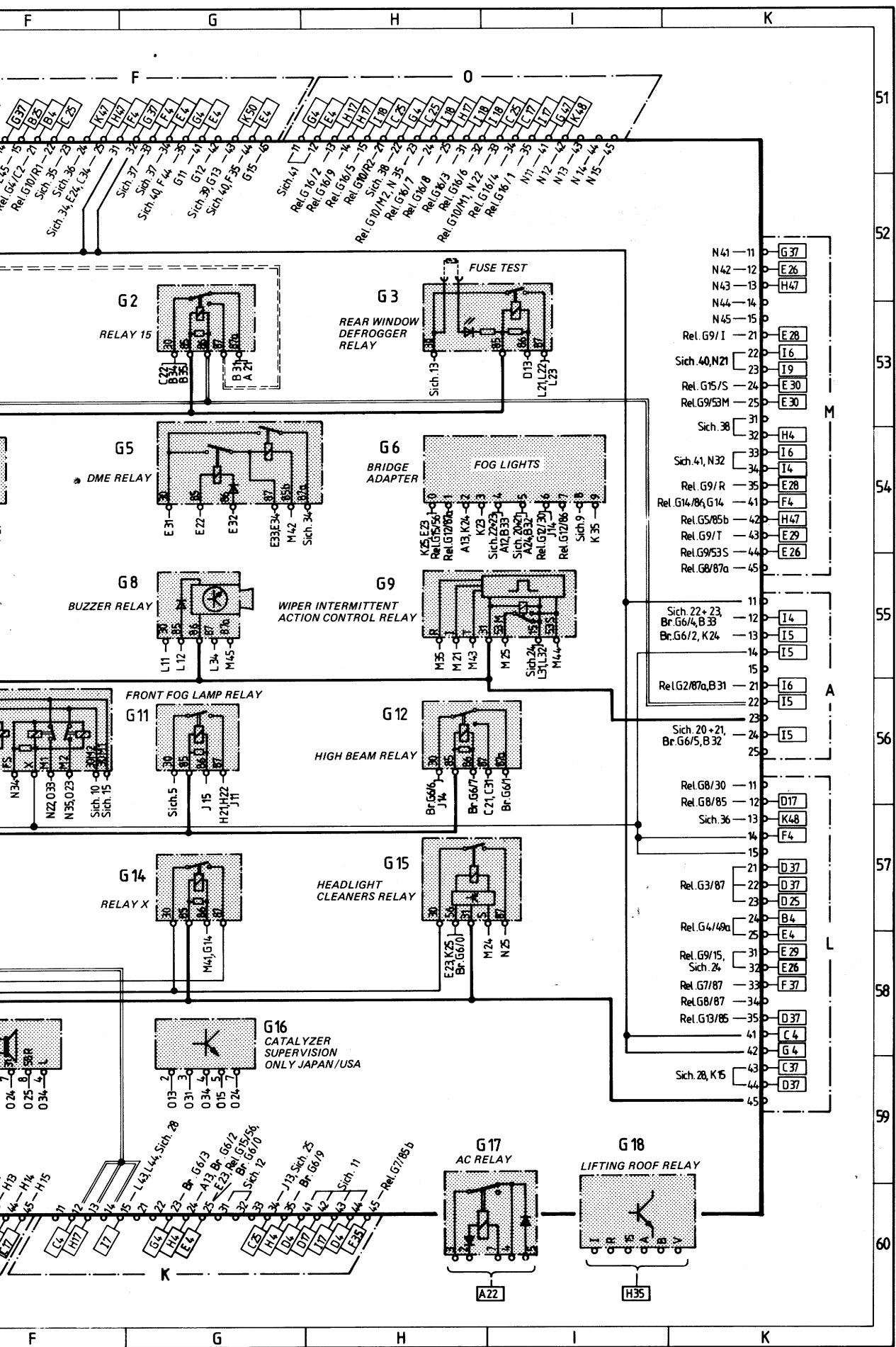

GR = GREY BR = BROWN BL = BLUE LI = VIOLET

Wiring Diagram Type 944, 944 turbo Model 86

SHEET 1	LIGHTING ROW/SA
SHEET 2	LIGHTING USA
SHEET 3	INSTRUMENT CLUSTER AND SENSORS ROW
SHEET 4	INSTRUMENT CLUSTER AND SENSORS USA/SA
SHEET 5	HEATING, AC, VENTILATION, ELECTR. SEATS, WIPER AND WASHER SYSTEM
SHEET 6	HORNS, MIRRORS, WINDOW LIFTERS, ALARM SYSTEM, TILTING ROOF
SHEET 7	ENGINE COMPARTMENT, TEMPOSTAT - 944
SHEET 8	ENGINE COMPARTMENT, TEMPOSTAT - 944 TURBO
SHEET 9	CENTRAL ELECTRICAL SYSTEM
SHEET 10	CENTRAL LOCKING SYSTEM
SHEET 11	FOG LIGHT, FOG TAIL LIGHT
SHEET 12	RADIO

Wiring Diagram Type 944, 944 turbo Model 86

The wiring diagram consists of twelve individual wiring diagrams. These are divided into coordinate fields.

Each individual wiring diagram contains a part of the central-electrics box in a dash-dotted frame.

This part of the central-electrics box shows all the lines and relays necessary for the individual wiring diagram.

The earth/ground points are identified by "MP" and their location is shown in a vehicle diagram.

The 20-pin connectors on the central-electrics box are clipped together out of 5 parts.

Part 1, with the moulded-on fastening lug, is the "starting element".

Parts 2, 3 and 4 are "module elements".

Parts 1 to 4 are identified by the numbers 1 5.

Part 5 is a "coding element".

The designations of the plug connections in the wiring diagram of the central-electrics box refer to the "starting element" from, for example, B 11 15, and to the first module element from B 21 25.

Wiring Diagram Type 944, 944 turbo Model 86 Sheet 1

LIGHTING ROW/SA

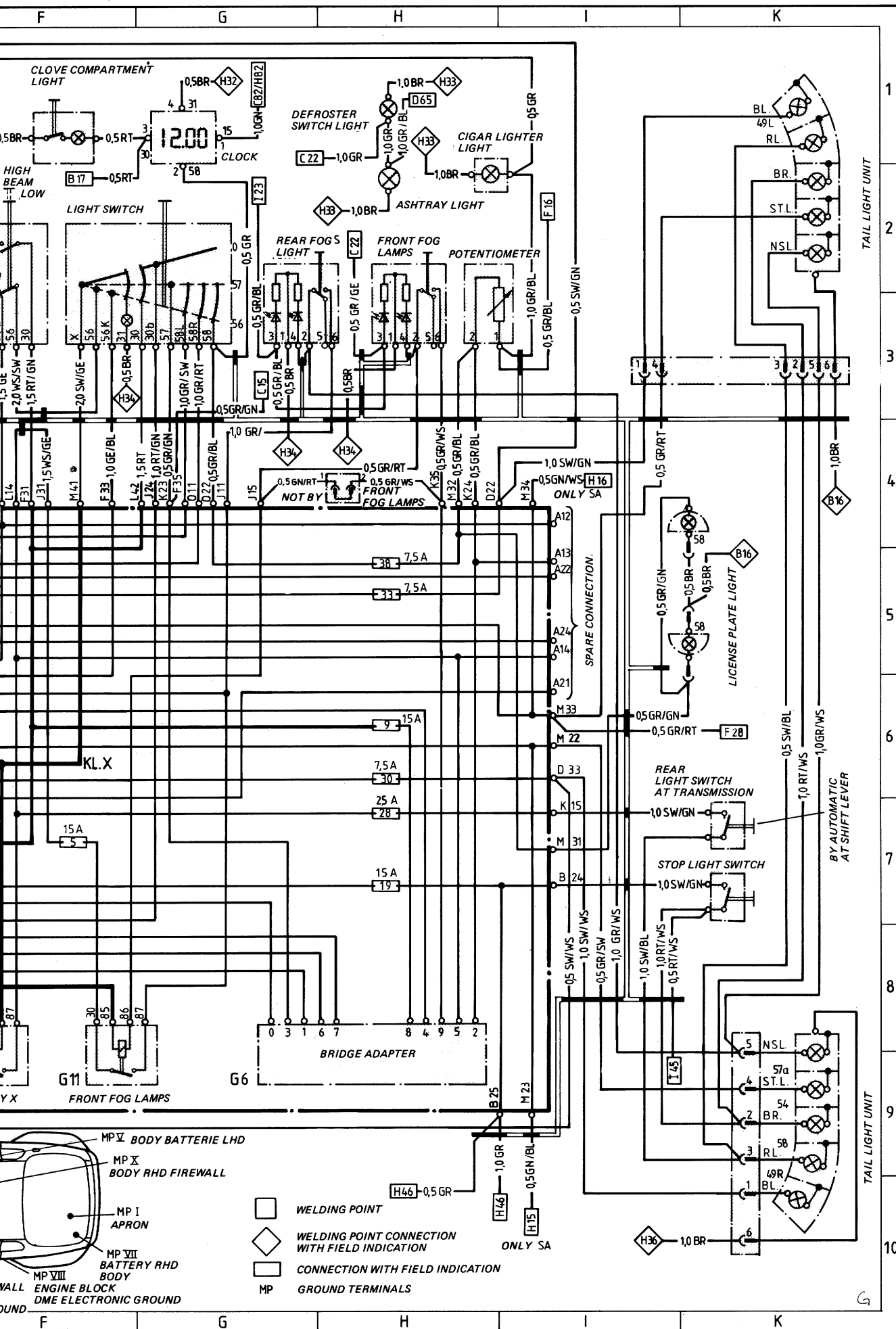

Wiring Diagram Type 944, 944 turbo Model 86 Sheet 2

LIGHTING USA

Wiring Diagram Type 944, 944 turbo Model 86 Sheet 2

LIGHTING USA

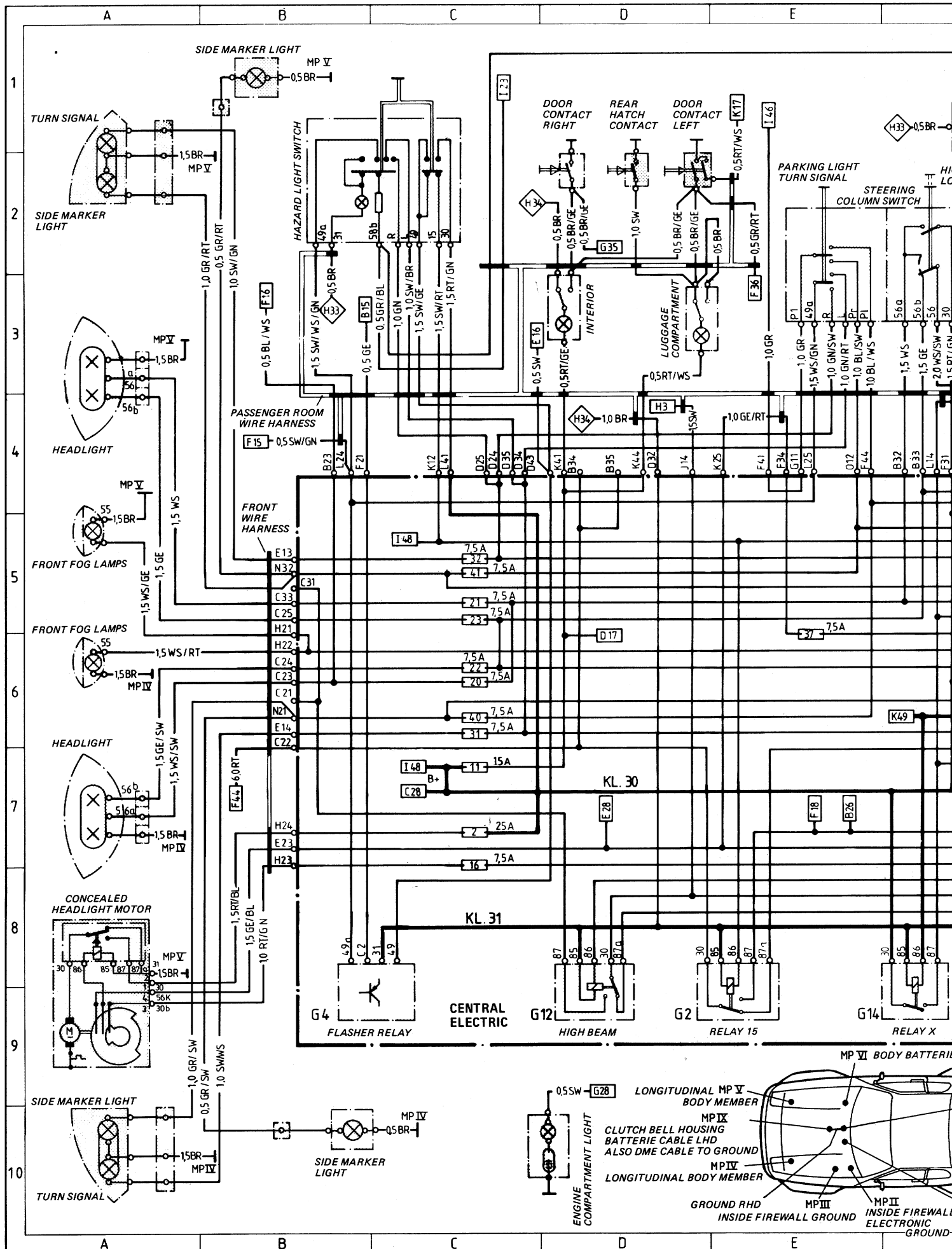

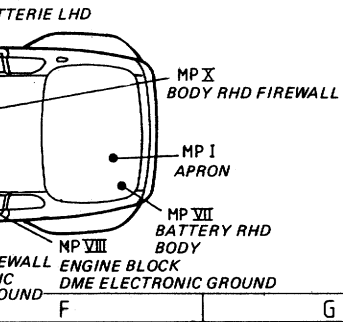
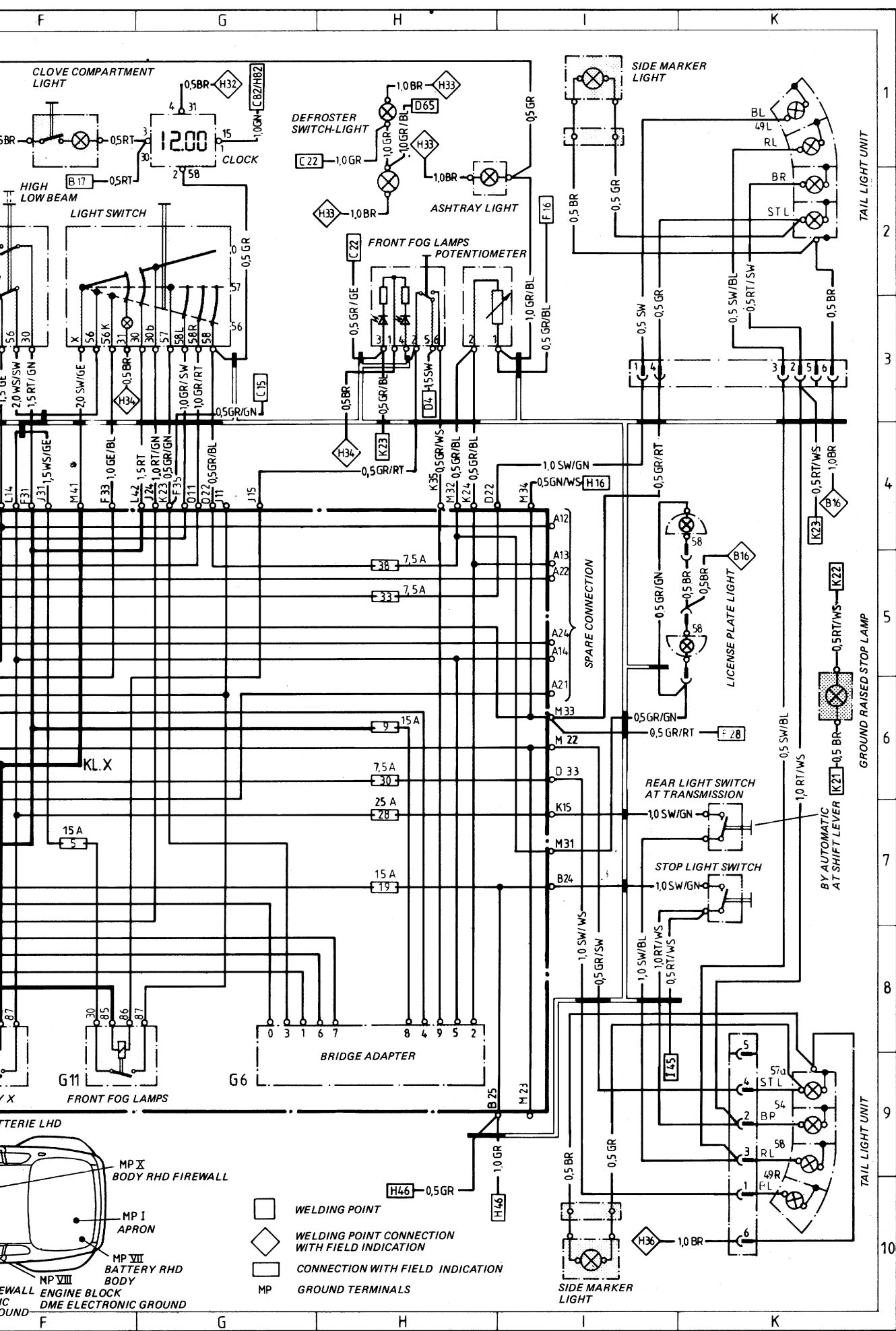

- WELDING POINT
- WELDING POINT CONNECTION WITH FIELD INDICATION
- CONNECTION WITH FIELD INDICATION
- GROUND TERMINALS

TAIL LIGHT UNIT

GROUND RAISED STOP LAMP

TAIL LIGHT UNIT

BY AUTOMATIC AT SHIFT LEVER

SIDE MARKER LIGHT

SPARE CONNECTION

LICENSE PLATE LIGHT

REAR LIGHT SWITCH AT TRANSMISSION

STOP LIGHT SWITCH

CLOVE COMPARTMENT LIGHT

HIGH LOW BEAM LIGHT SWITCH

DEFROSTER SWITCH-LIGHT

ASHTRAY LIGHT

FRONT FOG LAMP POTENTIOMETER

SIDE MARKER LIGHT

SIDE MARKER LIGHT

FRONT FOG LAMP

BRIDGE ADAPTER

BATTERY LHD

MP X BODY RHD FIREWALL

MP I APRON

MP VII BATTERY RHD BODY

MP VIII ENGINE BLOCK

FIREWALL

DME ELECTRONIC GROUND

GROUND

F G H I K

1
2
3
4
5
6
7
8
9
10

Wiring Diagram Type 944, 944 turbo Model 86 Sheet 3

INSTRUMENT CLUSTER AND SENSORS
ROW

Wiring Diagram Type 944, 944 turbo Model 86 Sheet 3

INSTRUMENT CLUSTER AND SENSORS ROW

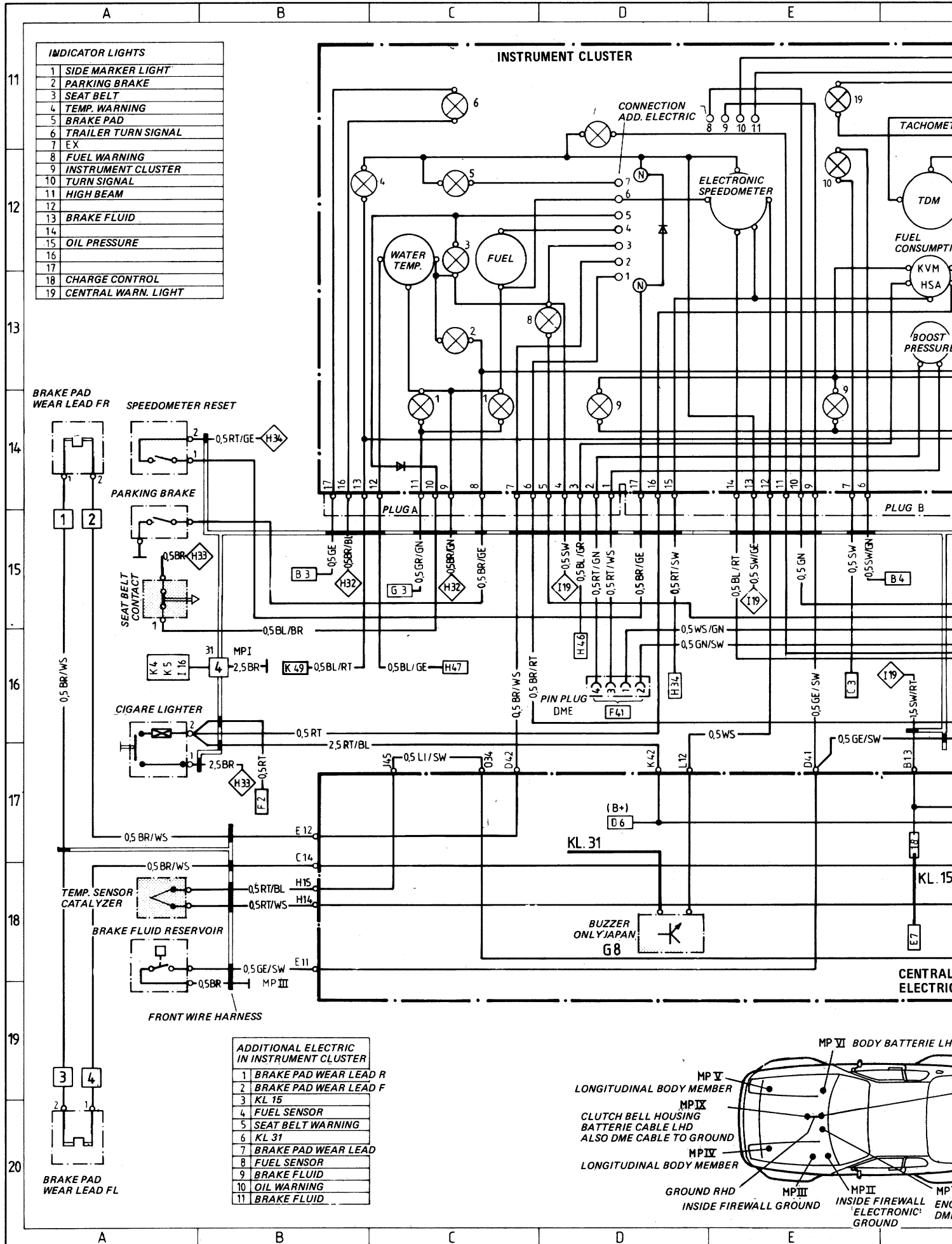

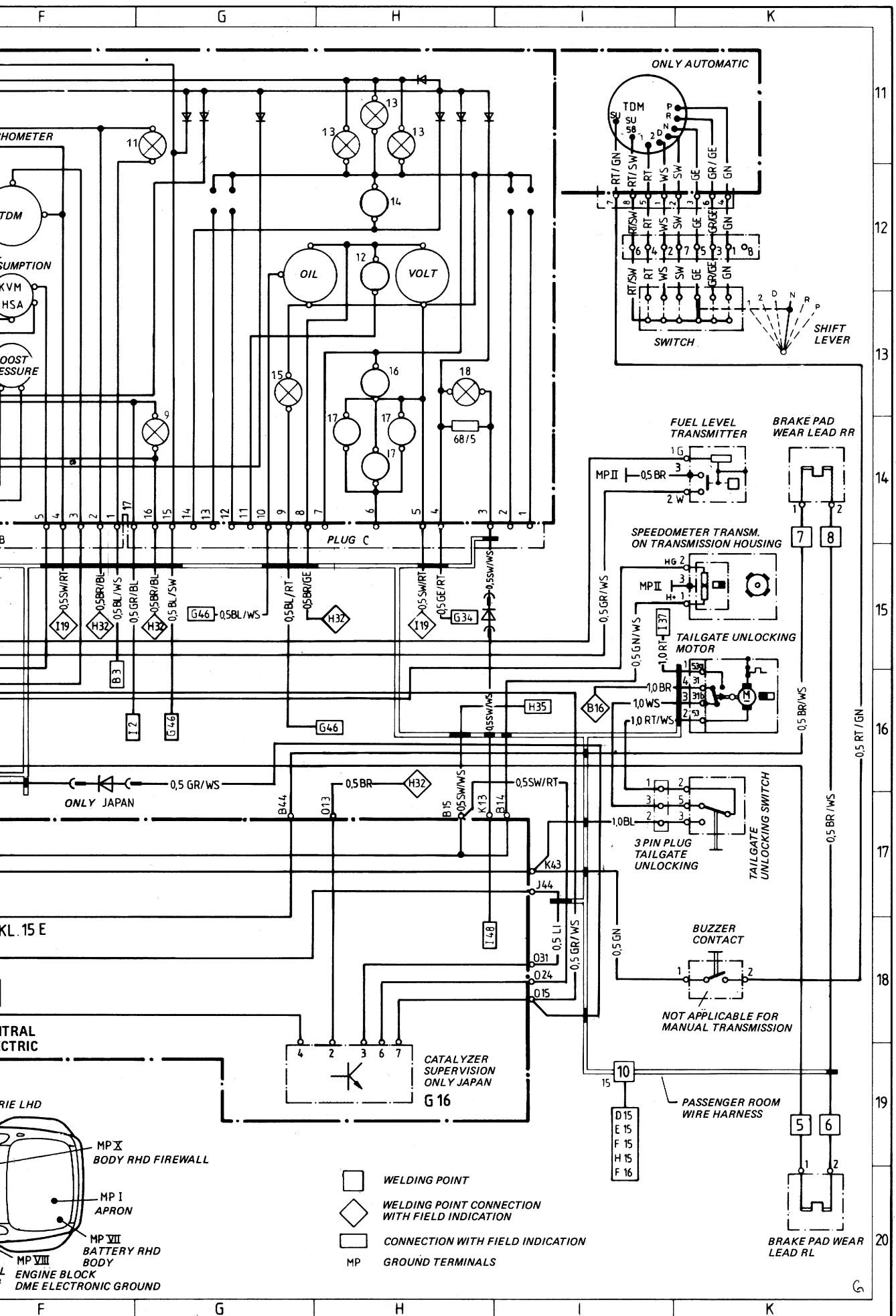

HOMETER
 TDM
 CONSUMPTION
 KVM
 HSA
 BOOST PRESSURE

ONLY AUTOMATIC

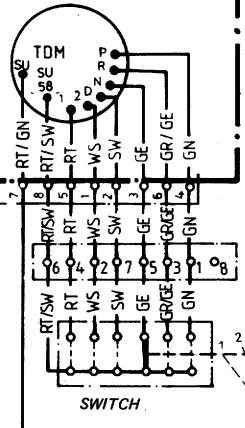

FUEL LEVEL TRANSMITTER
 BRAKE PAD WEAR LEAD RR

SPEEDOMETER TRANSM.
 ON TRANSMISSION HOUSING

TAILGATE UNLOCKING MOTOR

3 PIN PLUG
 TAILGATE UNLOCKING
 TAILGATE UNLOCKING SWITCH

BUZZER CONTACT

NOT APPLICABLE FOR MANUAL TRANSMISSION

PASSENGER ROOM WIRE HARNESS

BRAKE PAD WEAR LEAD RL

- WELDING POINT
- WELDING POINT CONNECTION WITH FIELD INDICATION
- CONNECTION WITH FIELD INDICATION
- GROUND TERMINALS

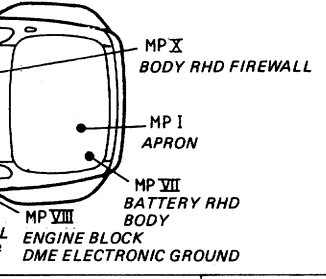

KL 15 E

CENTRAL ELECTRIC

MP X

MP I

MP VII

MP VIII

ENGINE BLOCK

DME ELECTRONIC GROUND

G

Wiring Diagram Type 944, 944 turbo Model 86 Sheet 4

INSTRUMENT CLUSTER AND SENSORS
USA/SA

Wiring Diagram Type 944, 944 turbo Model 86 Sheet 4

INSTRUMENT CLUSTER AND SENSORS USA/SA

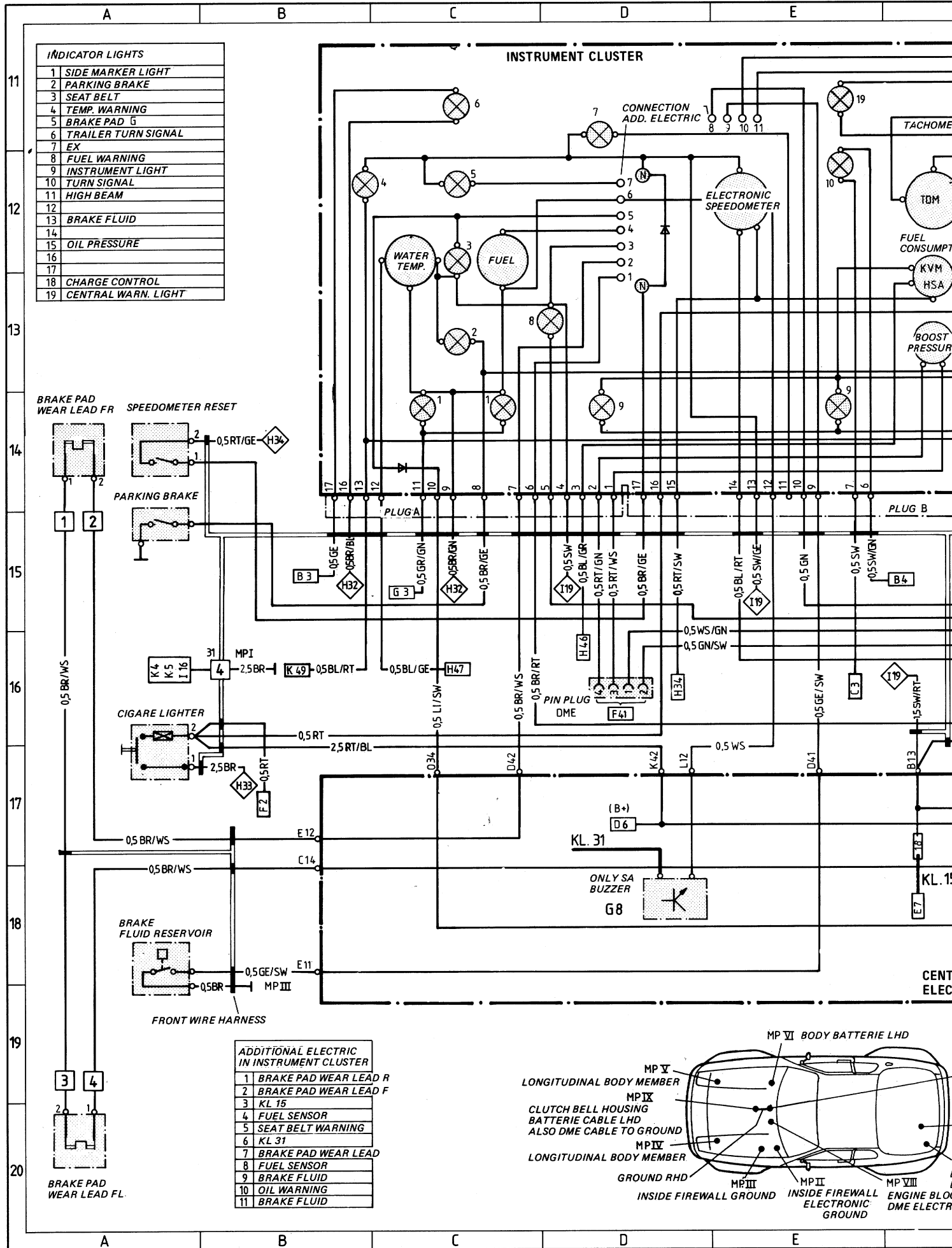

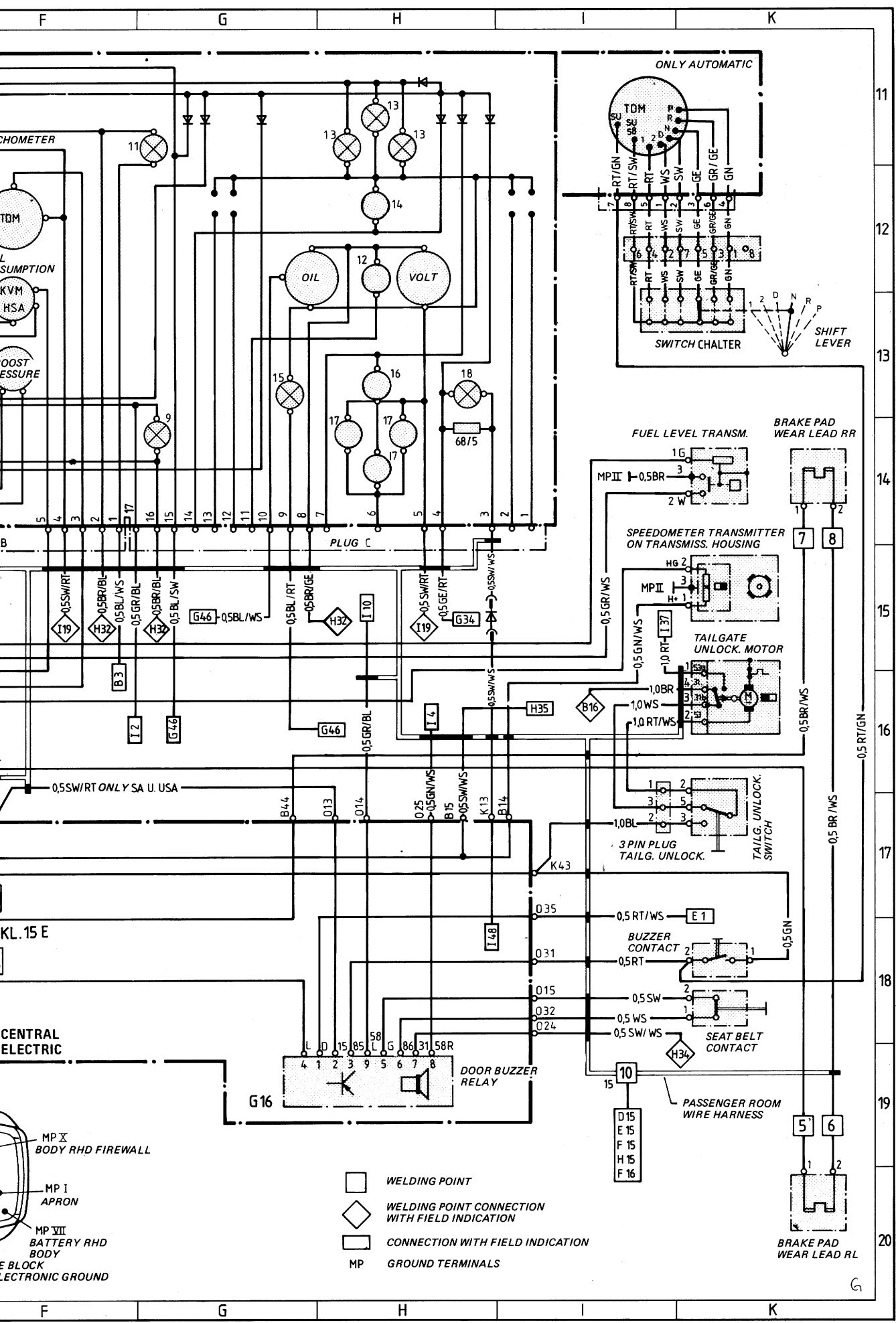

CHOMETER
TDM
L
SUMPTION
KVM
HSA
OOST
ESSURE

PLUG C

0.5 SW/RT ONLY SA U. USA

KL. 15 E

CENTRAL
ELECTRIC

MP X
BODY RHD FIREWALL

MP I
APRON

MP VII
BATTERY RHD
BODY

E BLOCK
ELECTRONIC GROUND

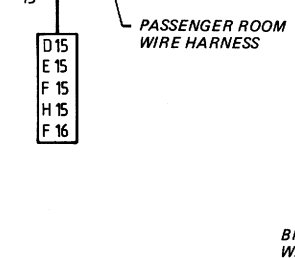
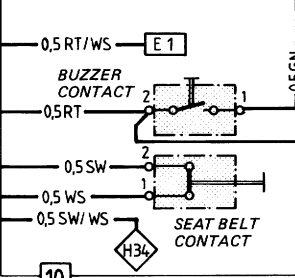
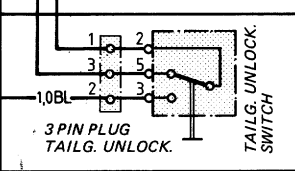
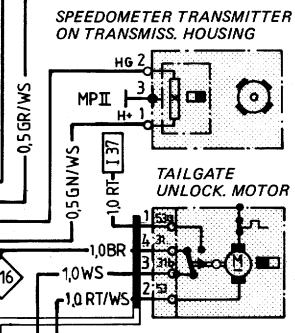
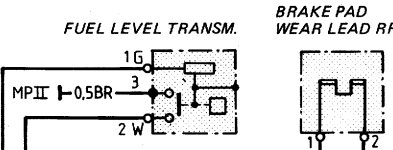
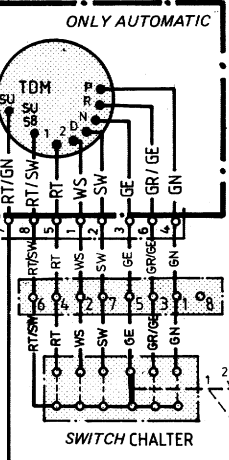

- WELDING POINT
- ◇ WELDING POINT CONNECTION WITH FIELD INDICATION
- ▭ CONNECTION WITH FIELD INDICATION
- MP GROUND TERMINALS

Wiring Diagram Type 944, 944 turbo Model 86 Sheet 5

HEATING, A C, VENTILATION, ELECTR.
SEATS, WIPER AND WASHER SYSTEM

Wiring Diagram Type 944, 944 turbo Model 86 Sheet 5

HEATING, AC, VENTILATION, ELECTR. SEATS, WIPER AND WASHER SYSTEM

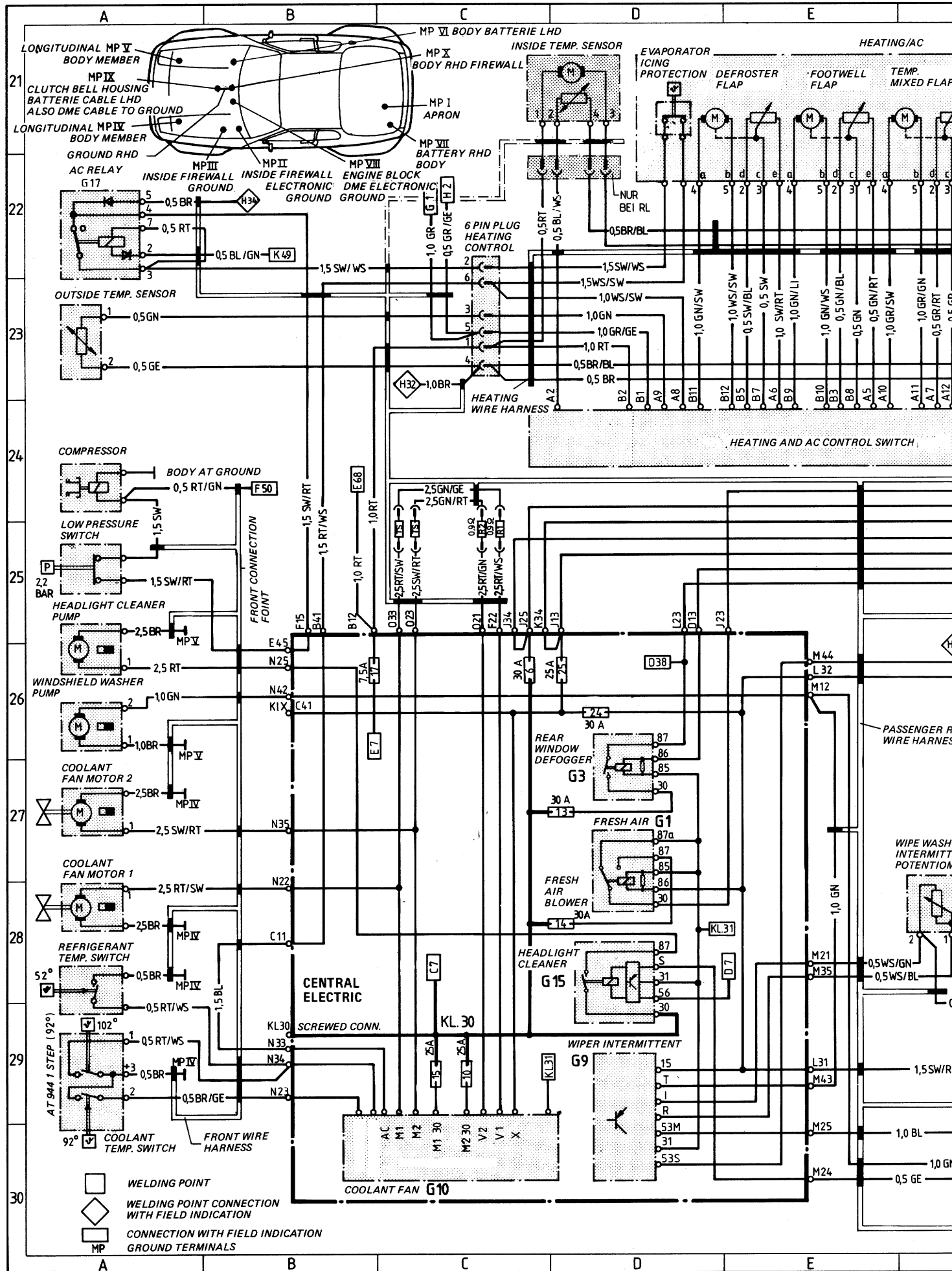

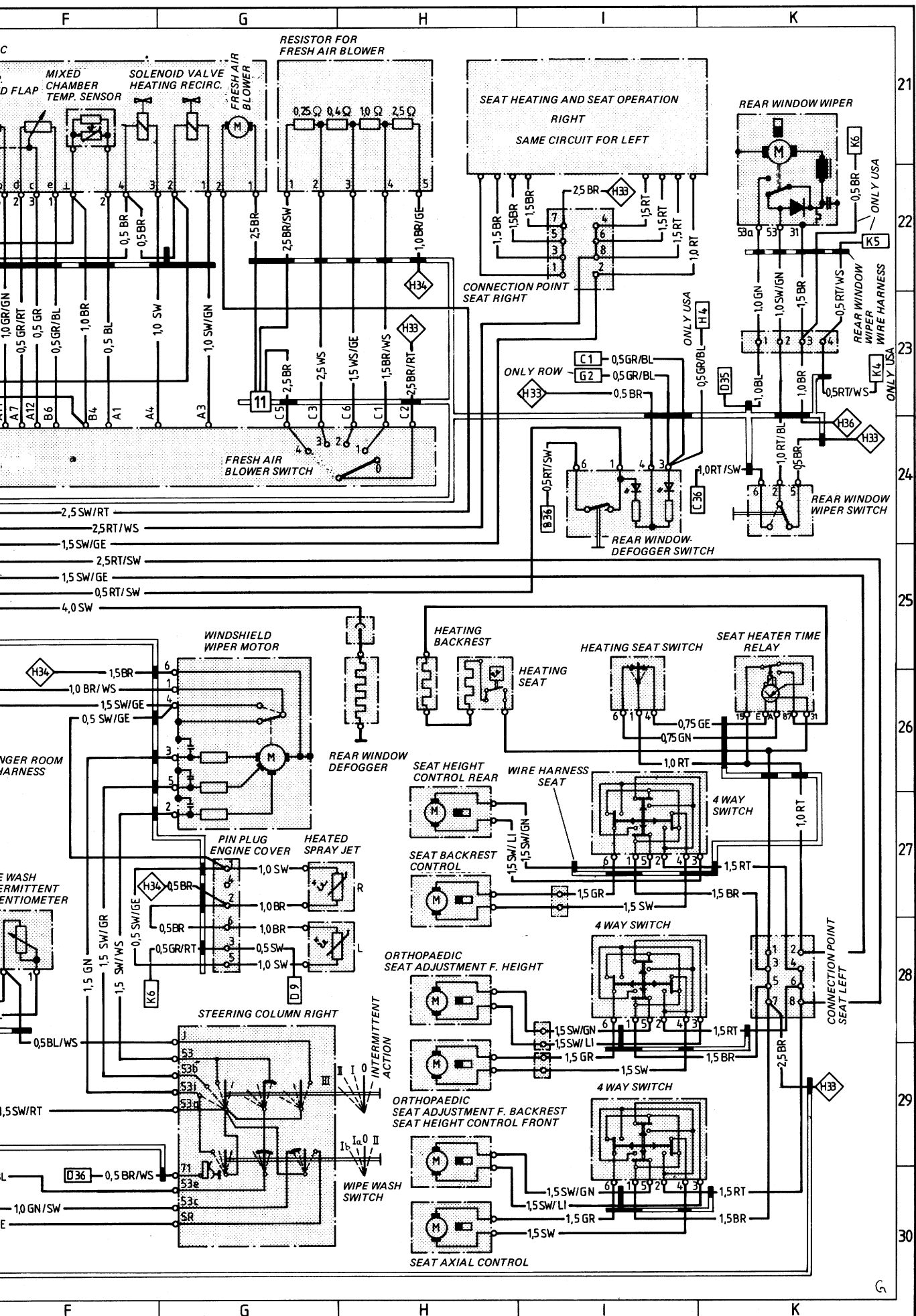

Wiring Diagram Type 944, 944 turbo Model 86 Sheet 6

HORNS, MIRRORS, WINDOW LIFTERS,
ALARM SYSTEM, TILTING ROOF

Wiring Diagram Type 944, 944 turbo Model 86 Sheet 6

HORNS, MIRRORS, WINDOW LIFTERS, ALARM SYSTEM, TILTING ROOF

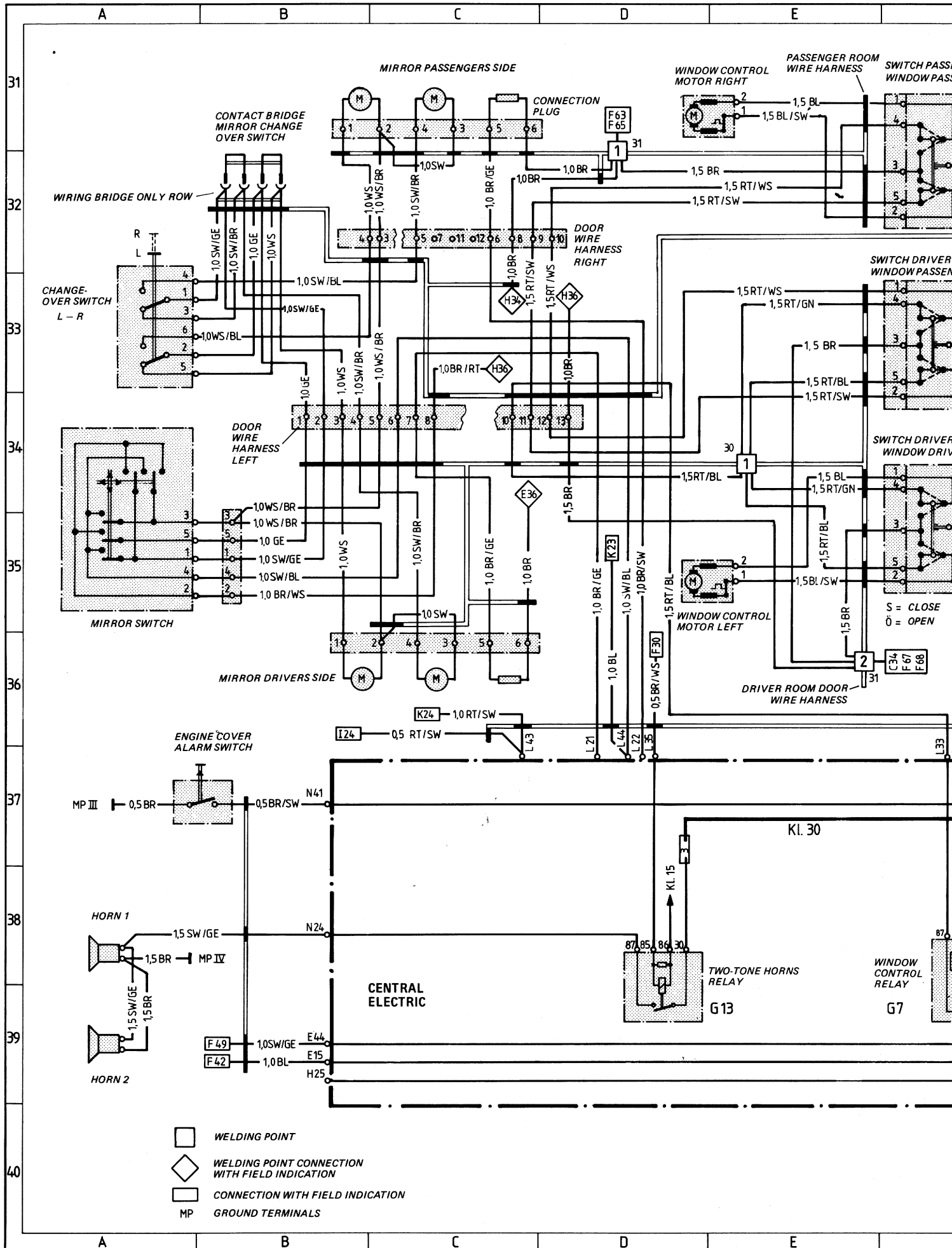

- WELDING POINT
- WELDING POINT CONNECTION WITH FIELD INDICATION
- CONNECTION WITH FIELD INDICATION
- MP GROUND TERMINALS

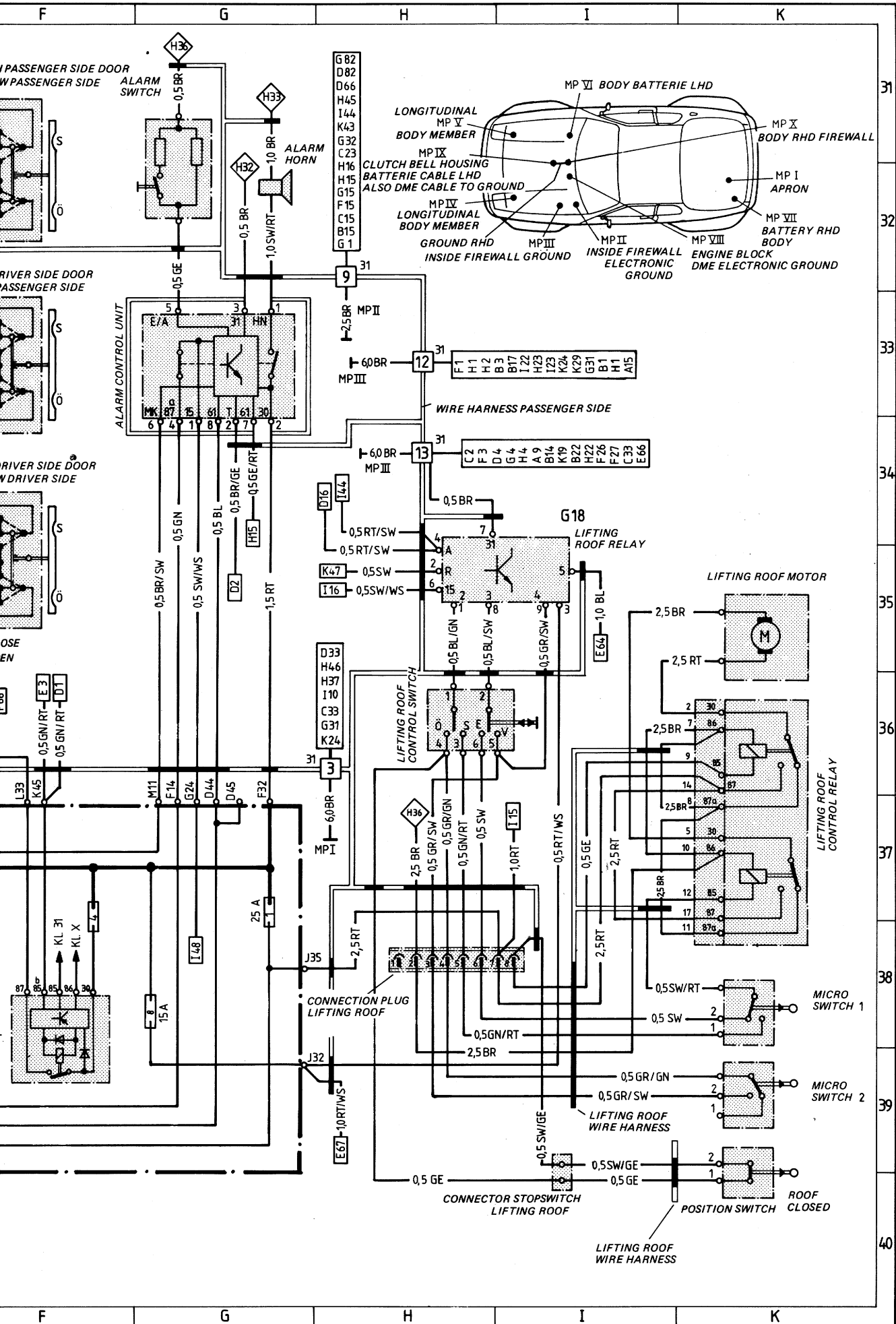

Wiring Diagram Type 944, 944 turbo Model 86 Sheet 7

ENGINE COMPARTMENT, TEMPOSTAT - 944

Wiring Diagram Type 944, 944 turbo Model 86 Sheet 7

ENGINE COMPARTMENT, TEMPOSTAT - 944

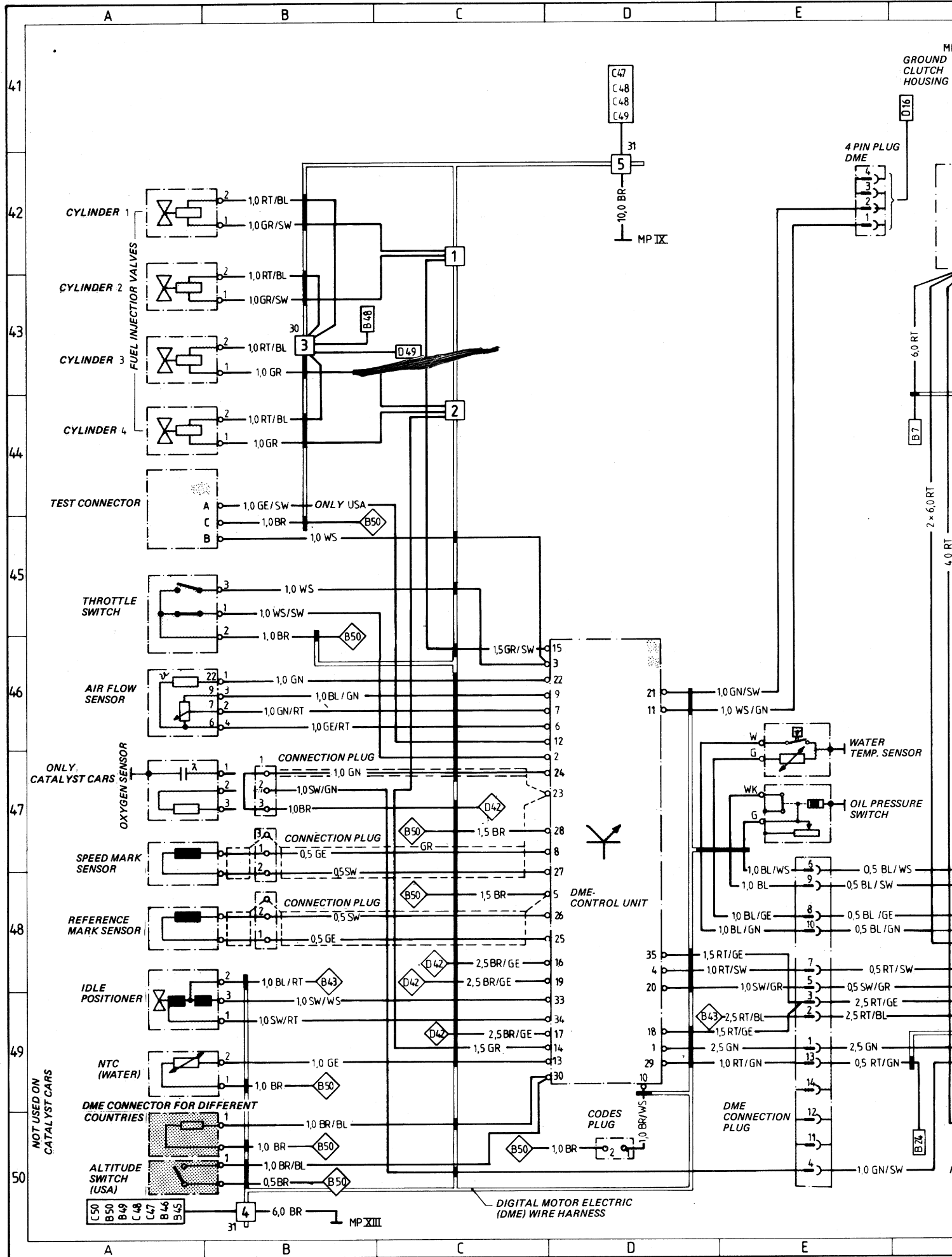

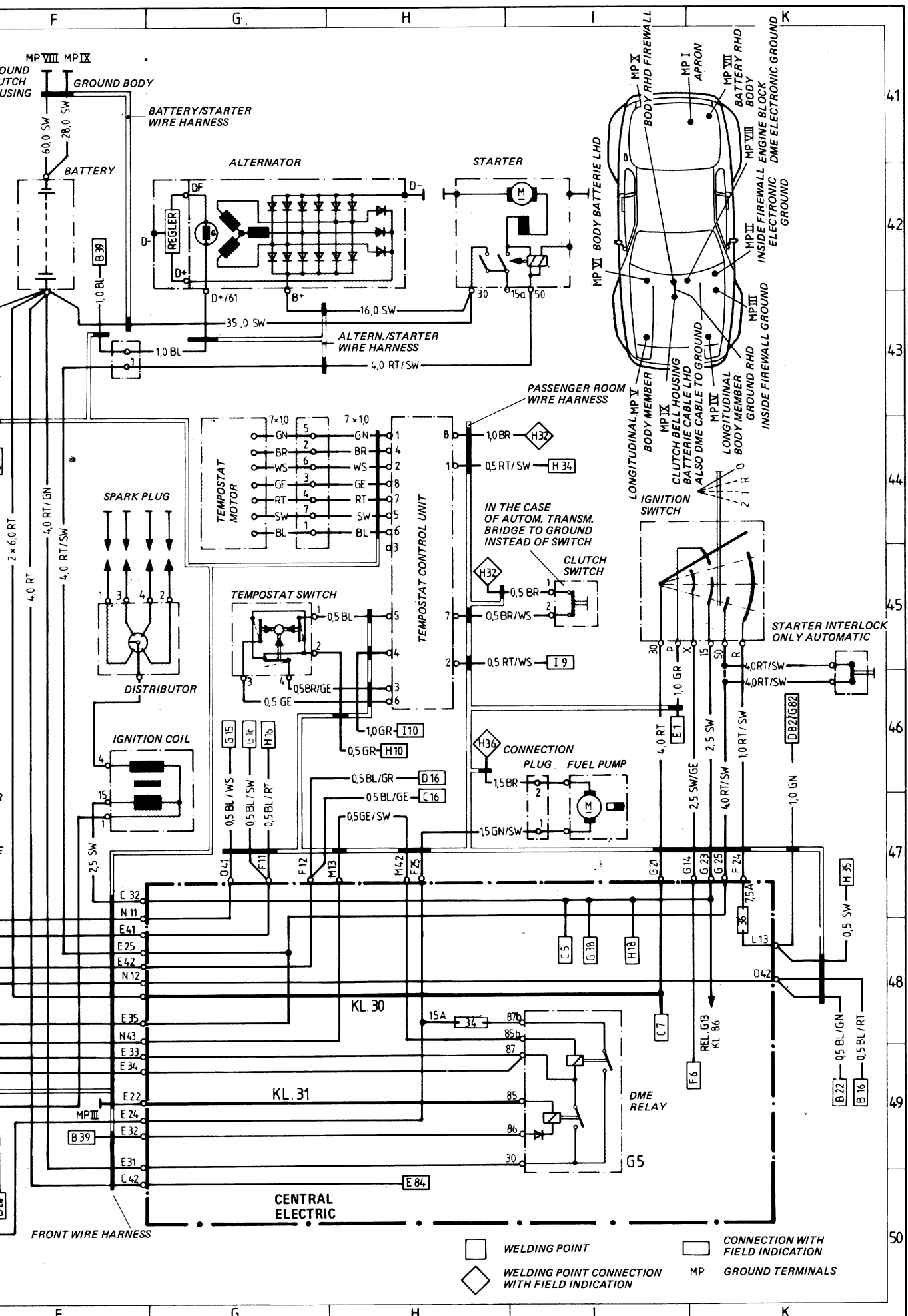

Wiring Diagram Type 944, 944 turbo Model 86 Sheet 8

ENGINE COMPARTMENT, TEMPOSTAT - 944 TURBO

Wiring Diagram Type 944, 944 turbo Model 86 Sheet 8

ENGINE COMPARTMENT, TEMPOSTAT - 944 TURBO

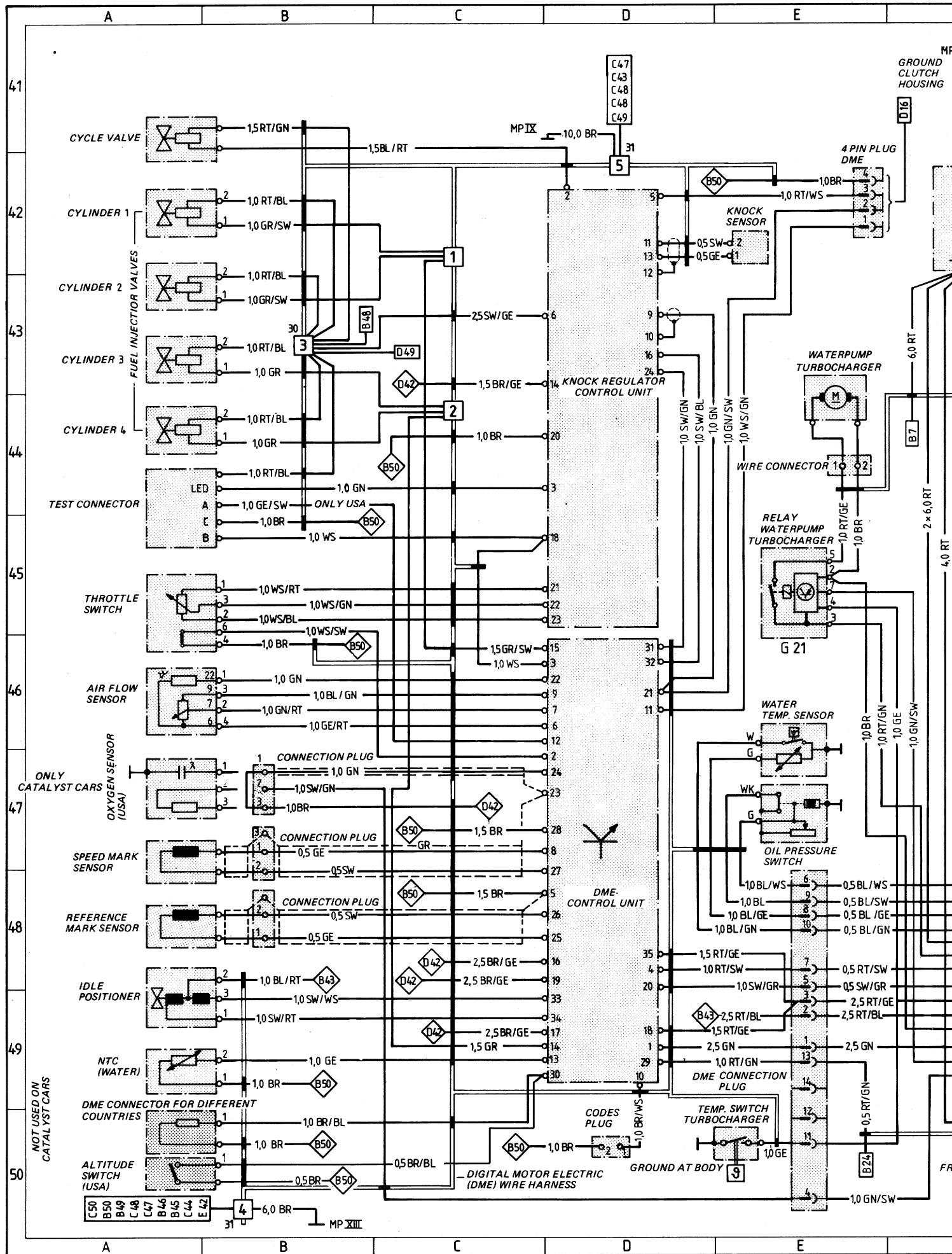

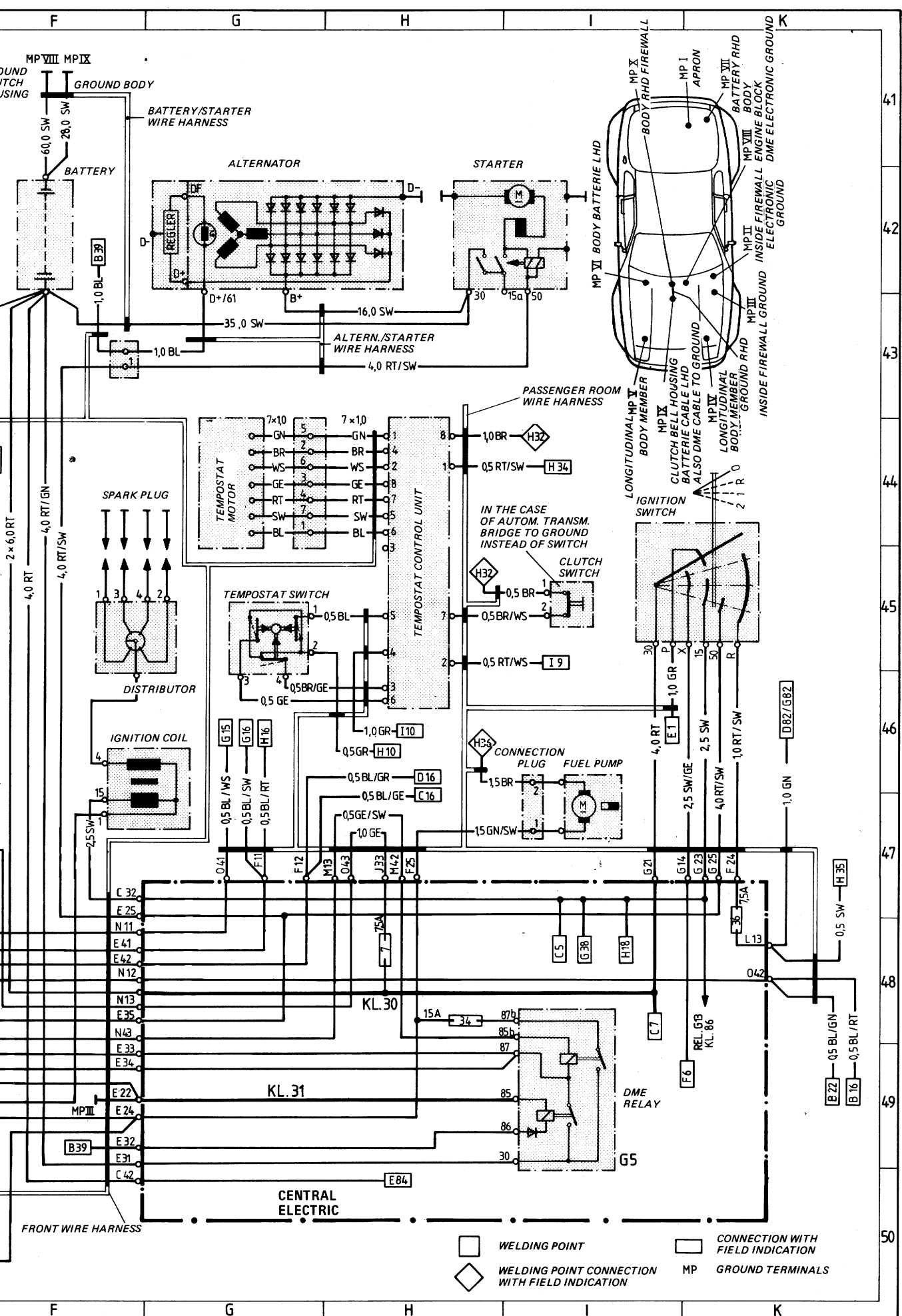

Wiring Diagram Type 944, 944 turbo Model 86 Sheet 9

CENTRAL ELECTRICAL SYSTEM

Wiring Diagram Type 944, 944 turbo Model 86 Sheet 9

CENTRAL ELECTRICAL SYSTEM

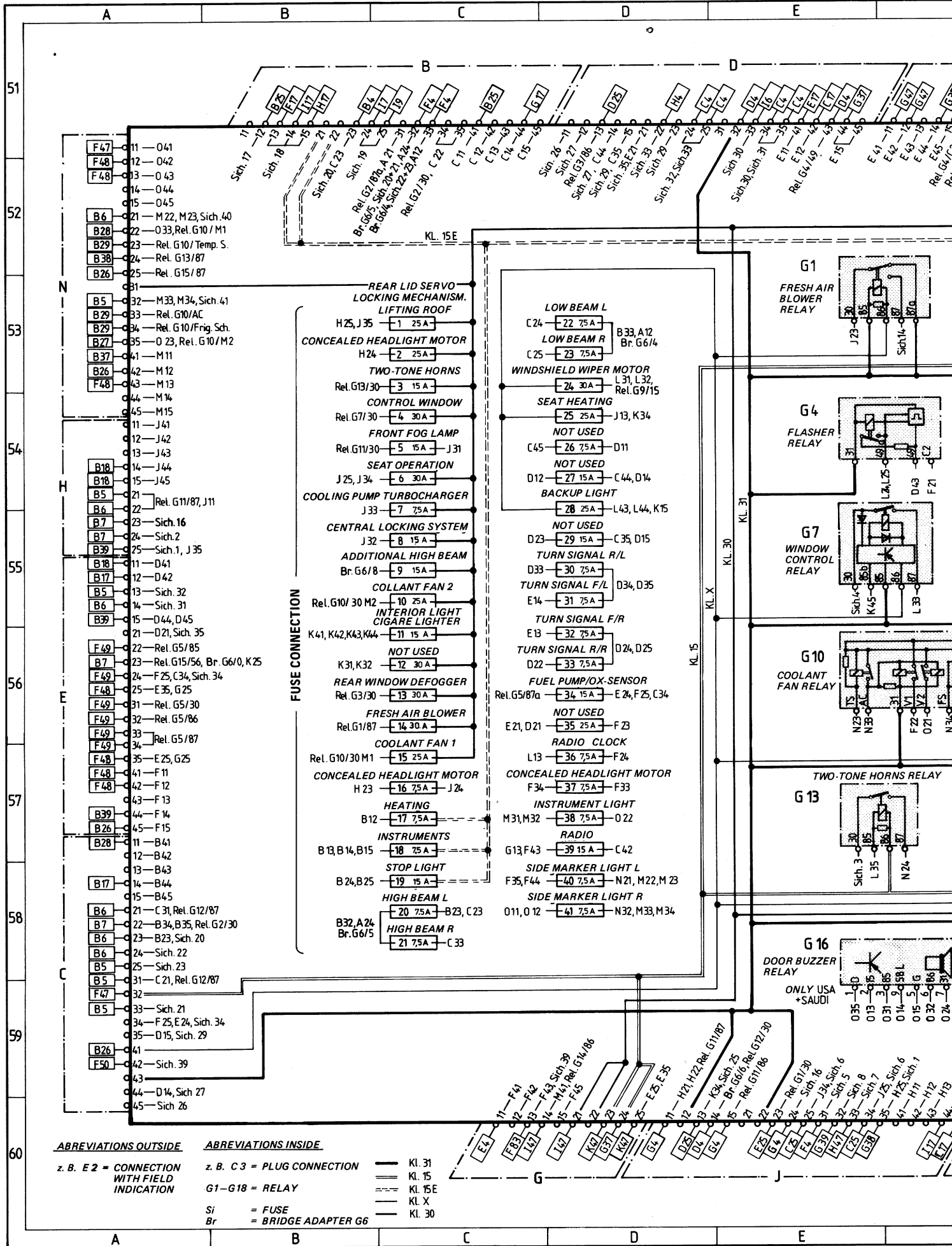

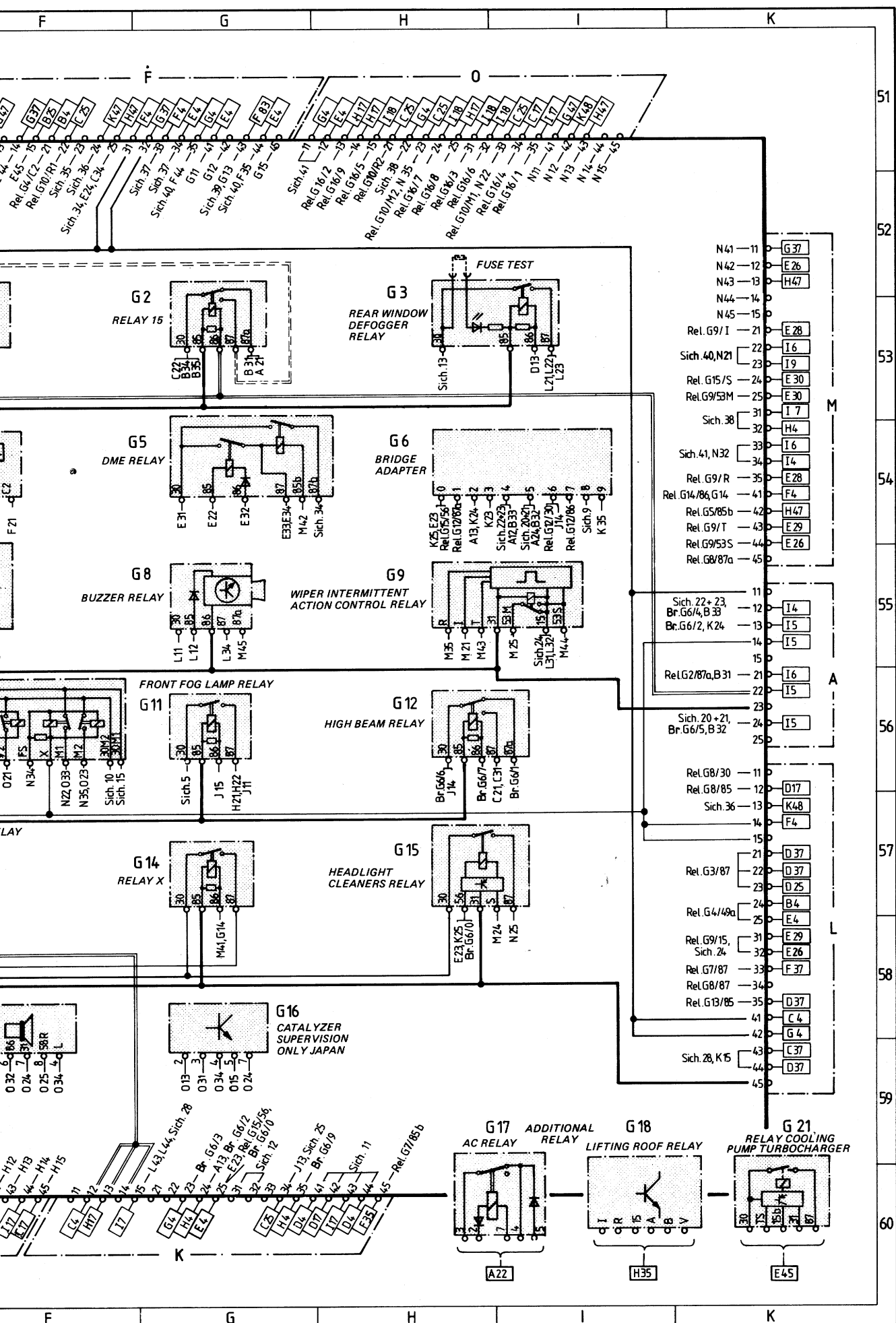

Wiring Diagram Type 944, 944 turbo Model 86 Sheet 10

CENTRAL LOCKING SYSTEM

Wiring Diagram Type 944, 944 turbo Model 86 Sheet 10

CENTRAL LOCKING SYSTEM

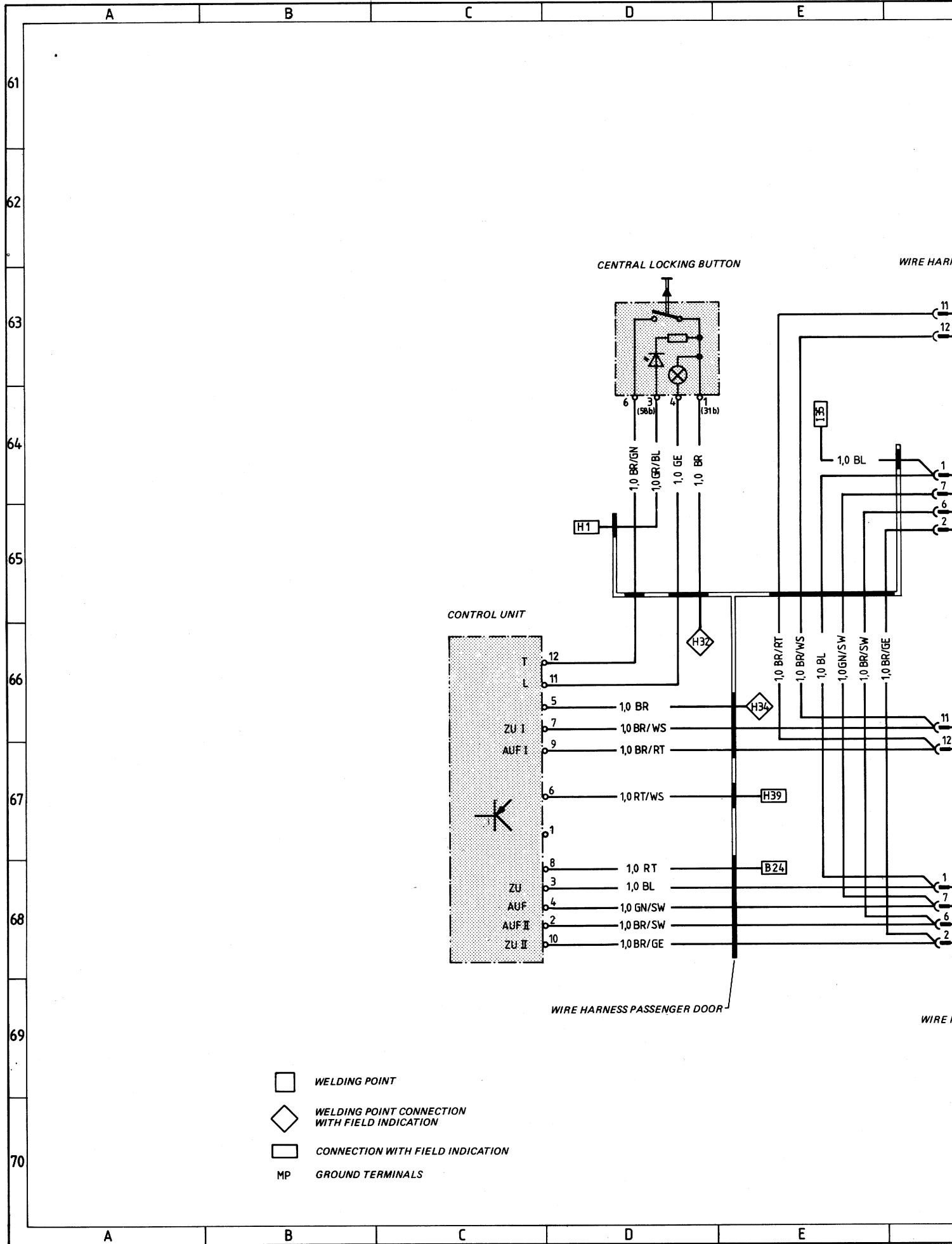

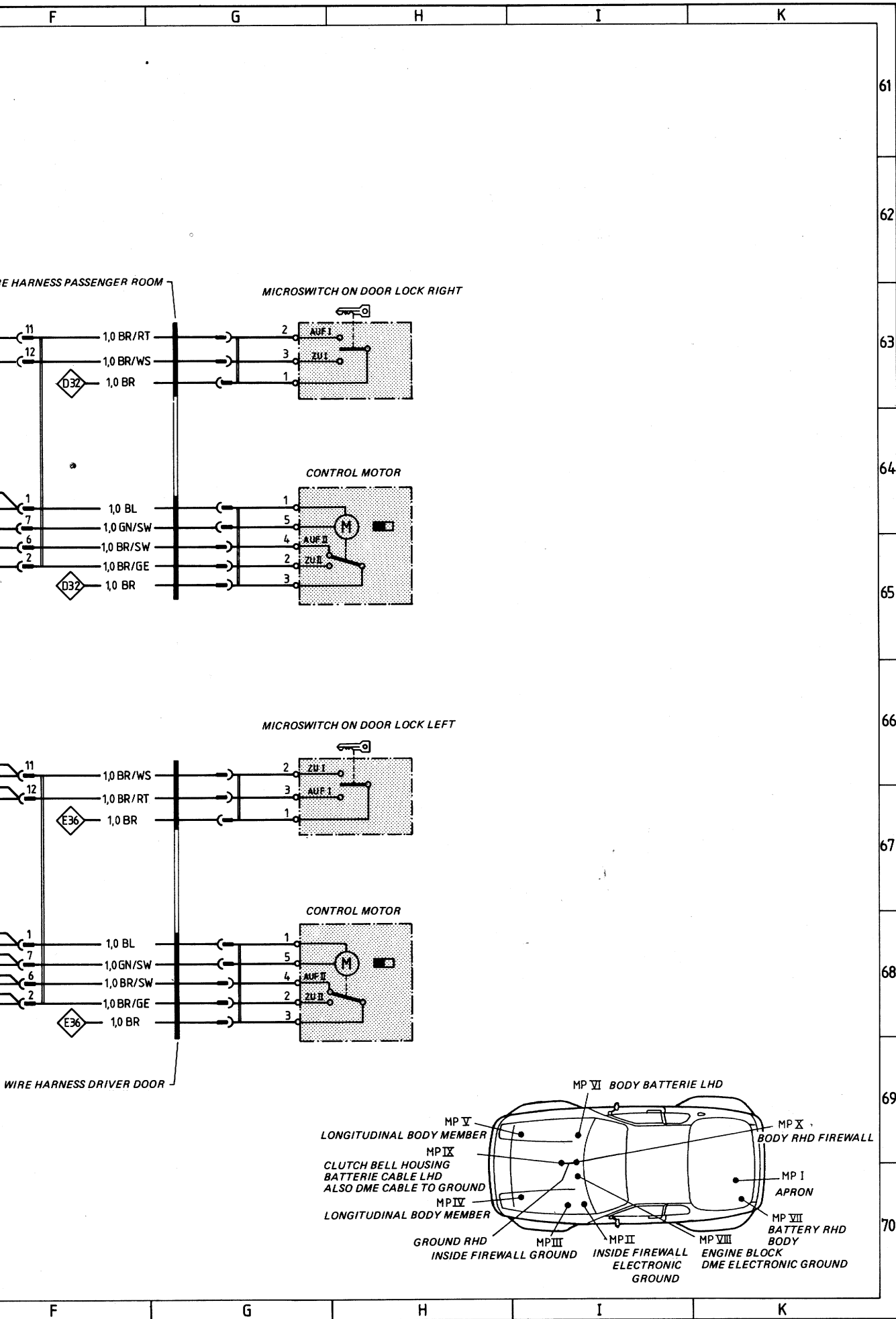

Wiring Diagram Type 944, 944 turbo Model 86 Sheet 11

FOG LIGHT, FOG TAIL LIGHT

Wiring Diagram Type 944, 944 turbo Model 86 Sheet 1

FOG LIGHT, FOG TAIL LIGHT

FOG LIGHT AND REAR FOG LIGHT-CIRCUIT

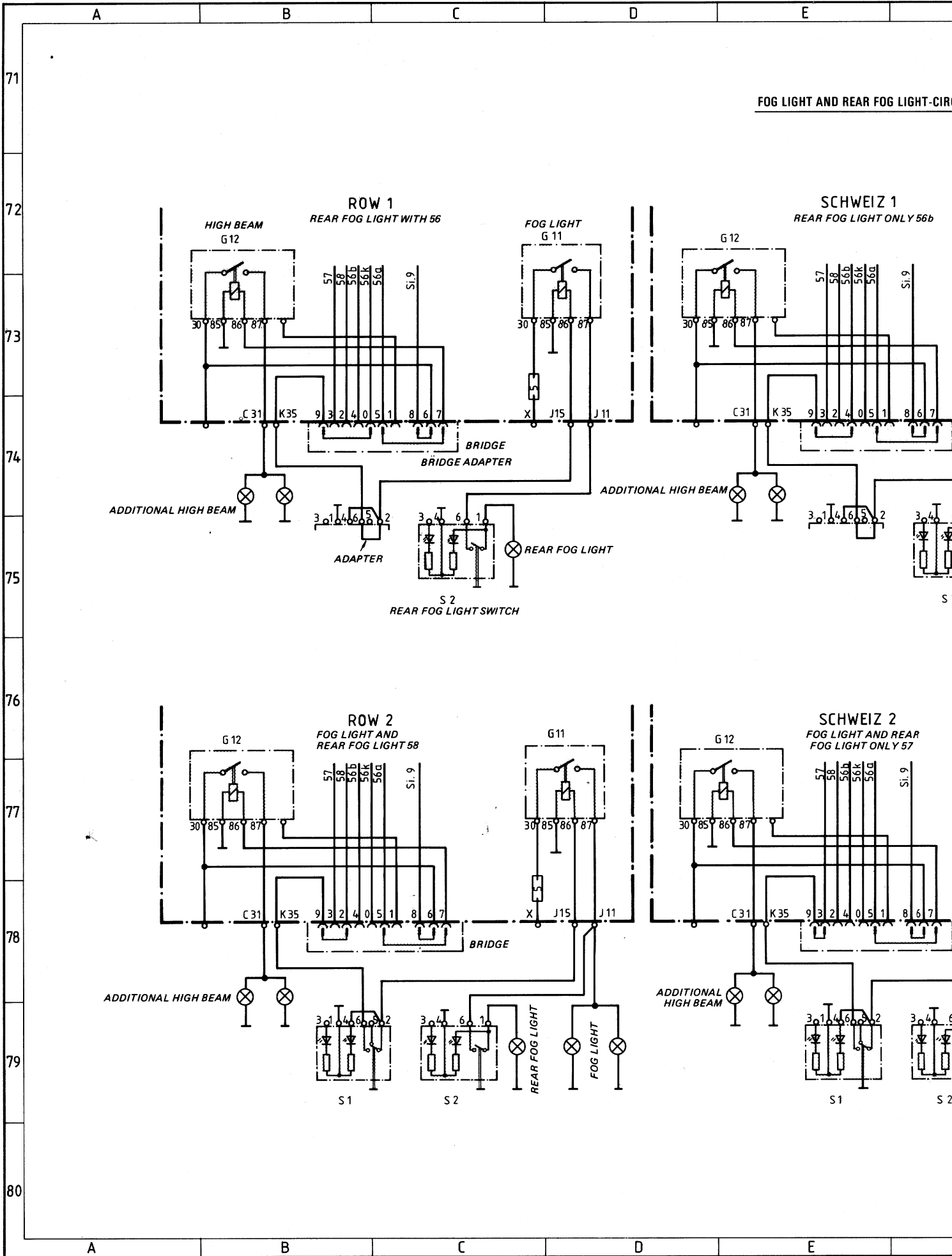

T-CIRCUIT

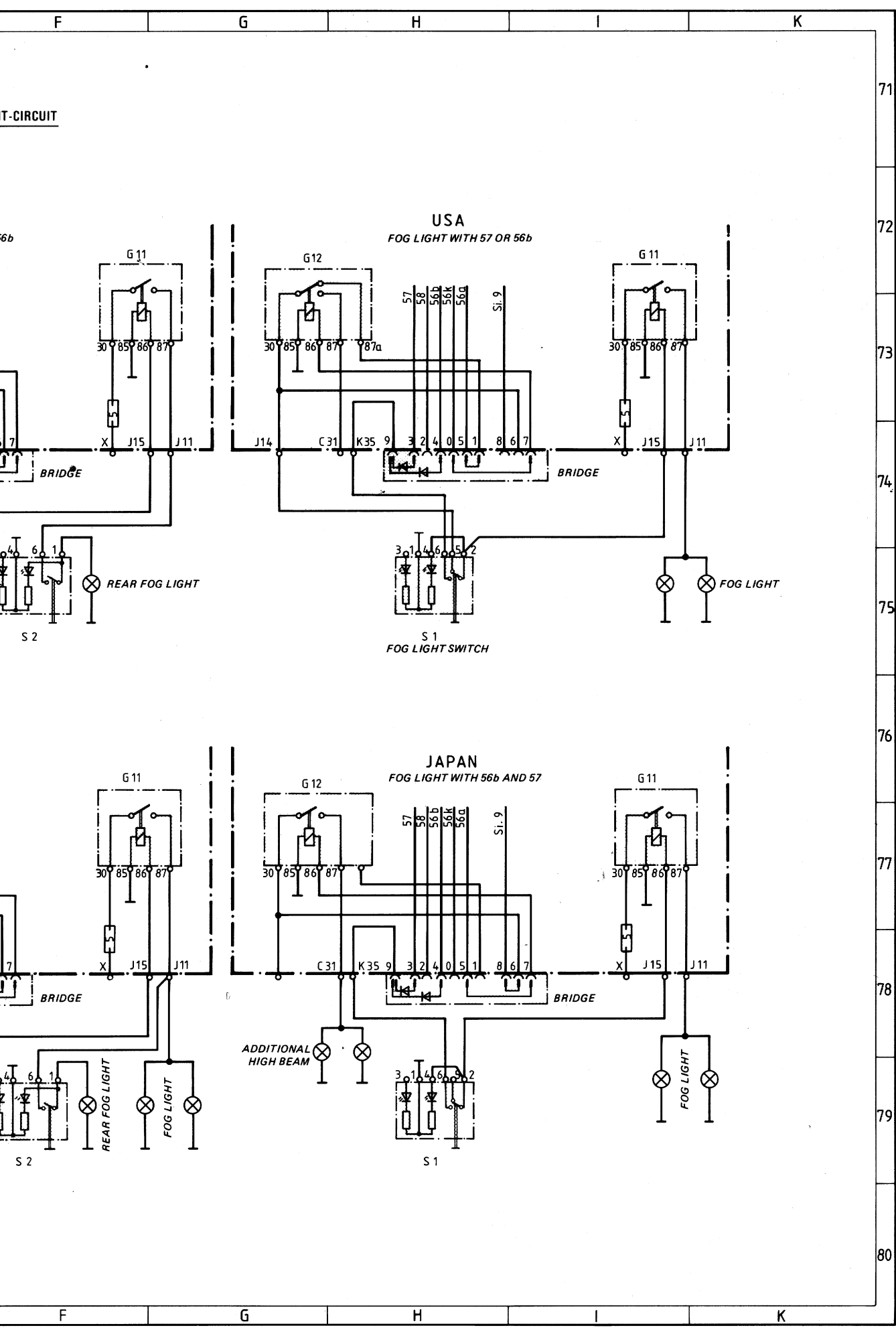

71
72
73
74
75
76
77
78
79
80

Wiring Diagram Type 944, 944 turbo Model 86 Sheet 12

RADIO

Wiring Diagram Type 944, 944 turbo Model 86 Sheet 12

RADIO

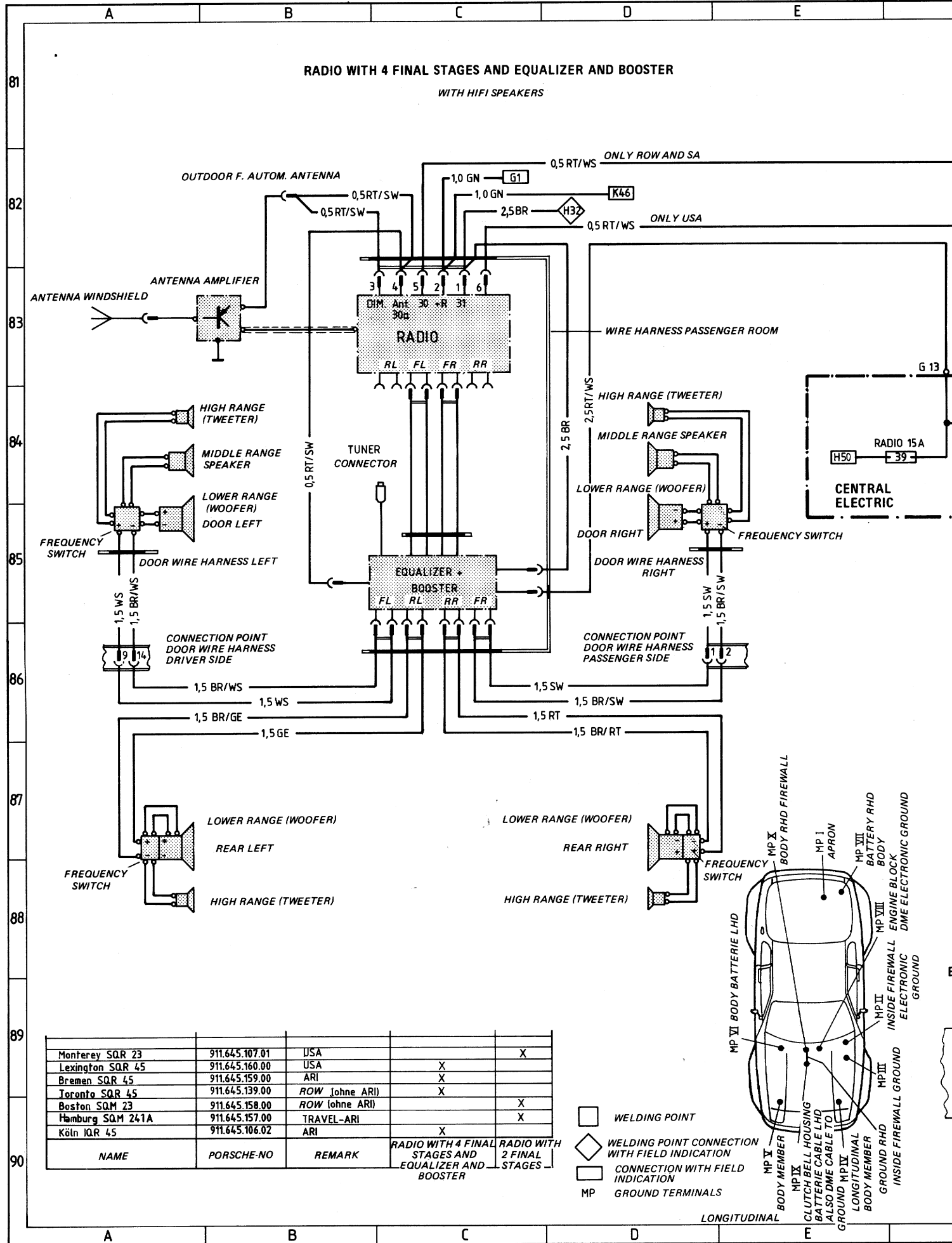

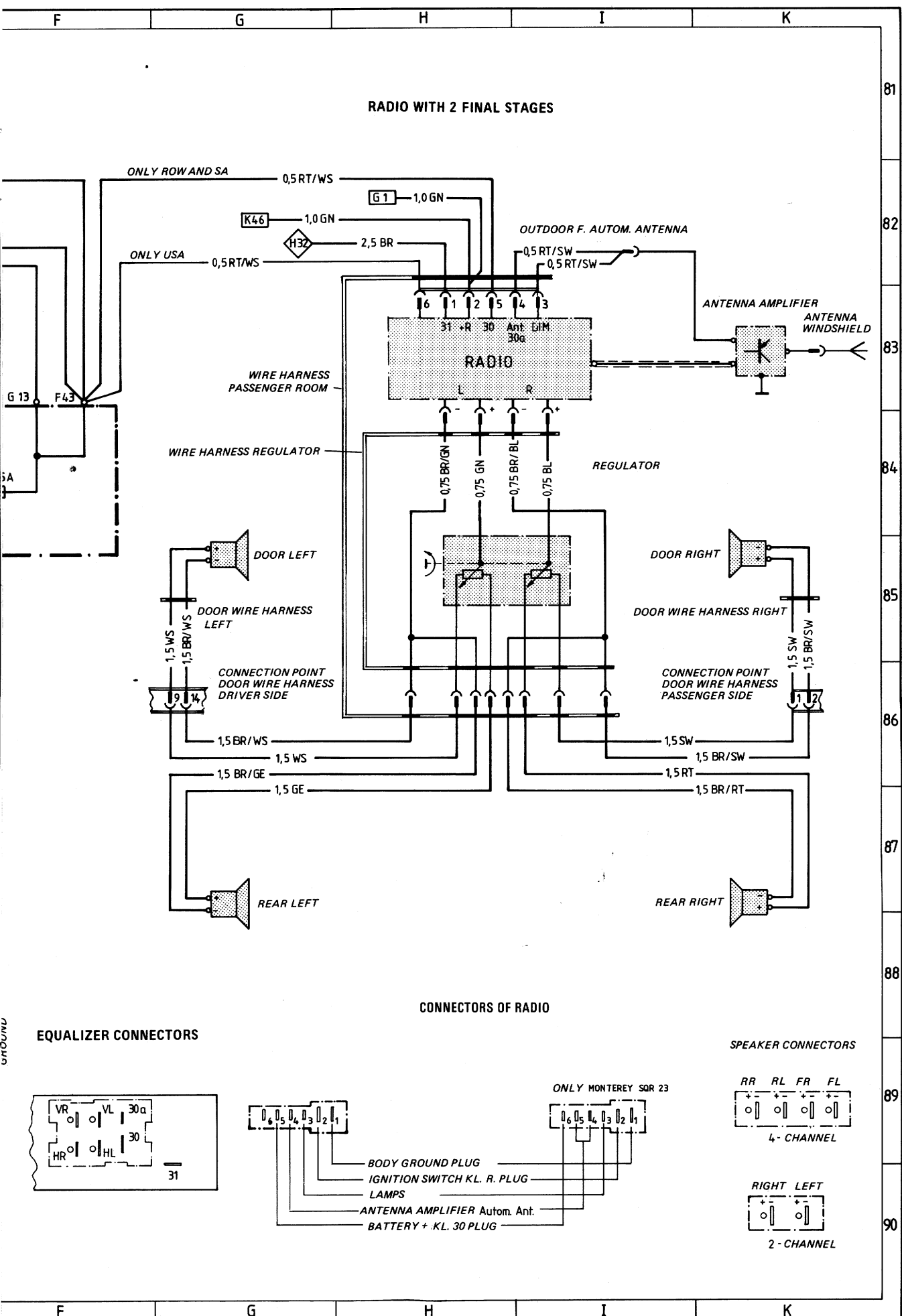

Wiring Diagram Type 944, 944 turbo 944 S Model 87

SHEET 1	LIGHTING ROW/SA
SHEET 2	LIGHTING USA
SHEET 3	INSTRUMENT CLUSTER AND SENSORS ROW
SHEET 4	INSTRUMENT CLUSTER AND SENSORS USA/SA
SHEET 5	HEATING, AC, VENTILATION, ELECTR. SEATS, WIPER AND WASHER SYSTEM
SHEET 6	HORNS, MIRRORS, WINDOW LIFTERS, ALARM SYSTEM, TILTING ROOF
SHEET 7	ENGINE COMPARTMENT, TEMPOSTAT - 944
SHEET 8	ENGINE COMPARTMENT, TEMPOSTAT - 944 TURBO
SHEET 9	ENGINE COMPARTMENT, TEMPOSTAT 4-VALVES
SHEET 10	CENTRAL ELECTRICAL SYSTEM
SHEET 11	CENTRAL LOCKING SYSTEM
SHEET 12	FOG LIGHT, FOG TAIL LIGHT
SHEET 13	RADIO
SHEET 14	ABS, AIRBAG

Wiring Diagram Type 944, 944 turbo 944 S Model 87

The wiring diagram consists of **14** individual wiring diagrams. These are divided into coordinate fields.

Each individual wiring diagram contains a part of the central-electrics box in a dash-dotted frame.

This part of the central-electrics box shows all the lines and relays necessary for the individual wiring diagram.

The earth/ground points are identified by "MP" and their location is shown in a vehicle diagram.

The 20-pin connectors on the central-electrics box are clipped together out of 5 parts.

Part 1, with the moulded-on fastening lug, is the "starting element".

Parts 2, 3 and 4 are "module elements".

Parts 1 to 4 are identified by the numbers 1 5.

Part 5 is a "coding element".

The designations of the plug connections in the wiring diagram of the central-electrics box refer to the "starting element" from, for example, B 11 15, and to the first module element from B 21 25.

Wiring Diagram Type 944, 944 turbo 944 S Model 87 Sheet 1

LIGHTING ROW/SA

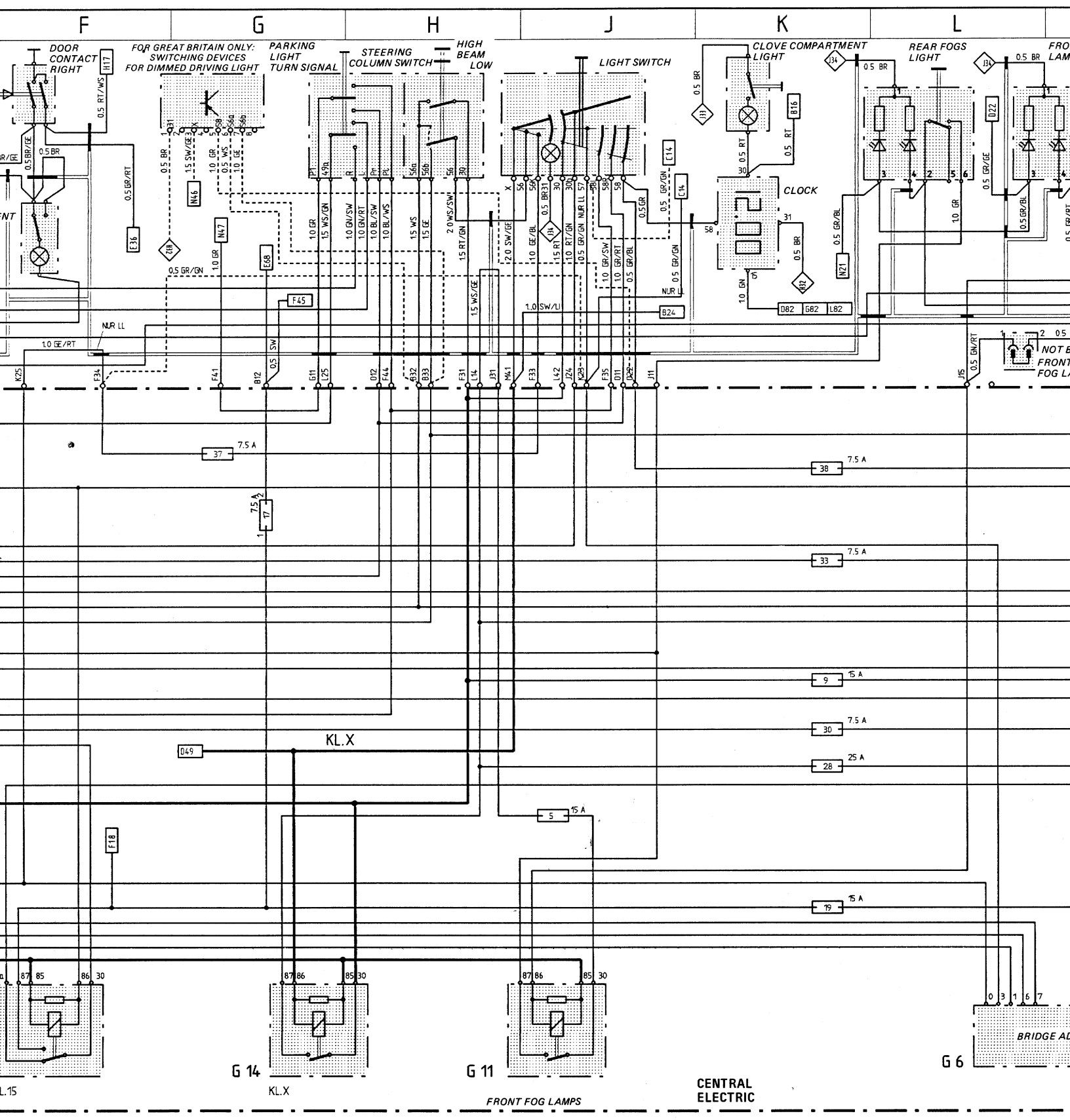

MP = GROUND TERMINALS

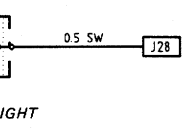

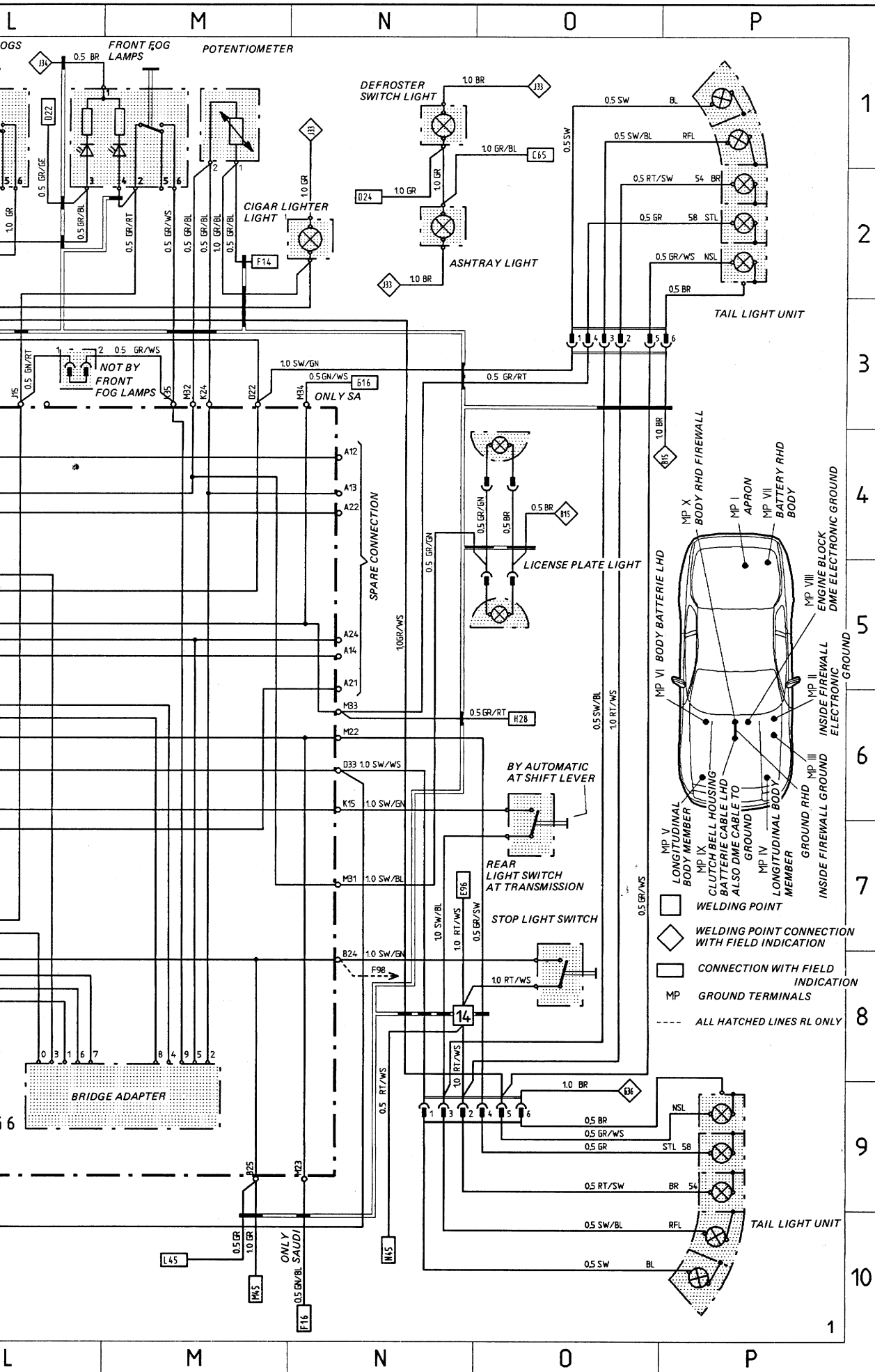

- MP V LONGITUDINAL BODY MEMBER
 - MP IX CLUTCH BELL HOUSING
 - MP X BATTERY CABLE TO GROUND
 - MP IV LONGITUDINAL BODY MEMBER
 - MP III GROUND RHD
 - MP II INSIDE FIREWALL ELECTRONIC GROUND
 - MP I APRON
 - MP VII BATTERY RHD BODY
 - MP VIII ENGINE BLOCK DME ELECTRONIC GROUND
- WELDING POINT
 - ◇ WELDING POINT CONNECTION WITH FIELD INDICATION
 - ▭ CONNECTION WITH FIELD INDICATION
 - MP GROUND TERMINALS
 - ALL HATCHED LINES RL ONLY

Wiring Diagram Type 944, 944 turbo 944 S Model 87 Sheet 2

LIGHTING USA

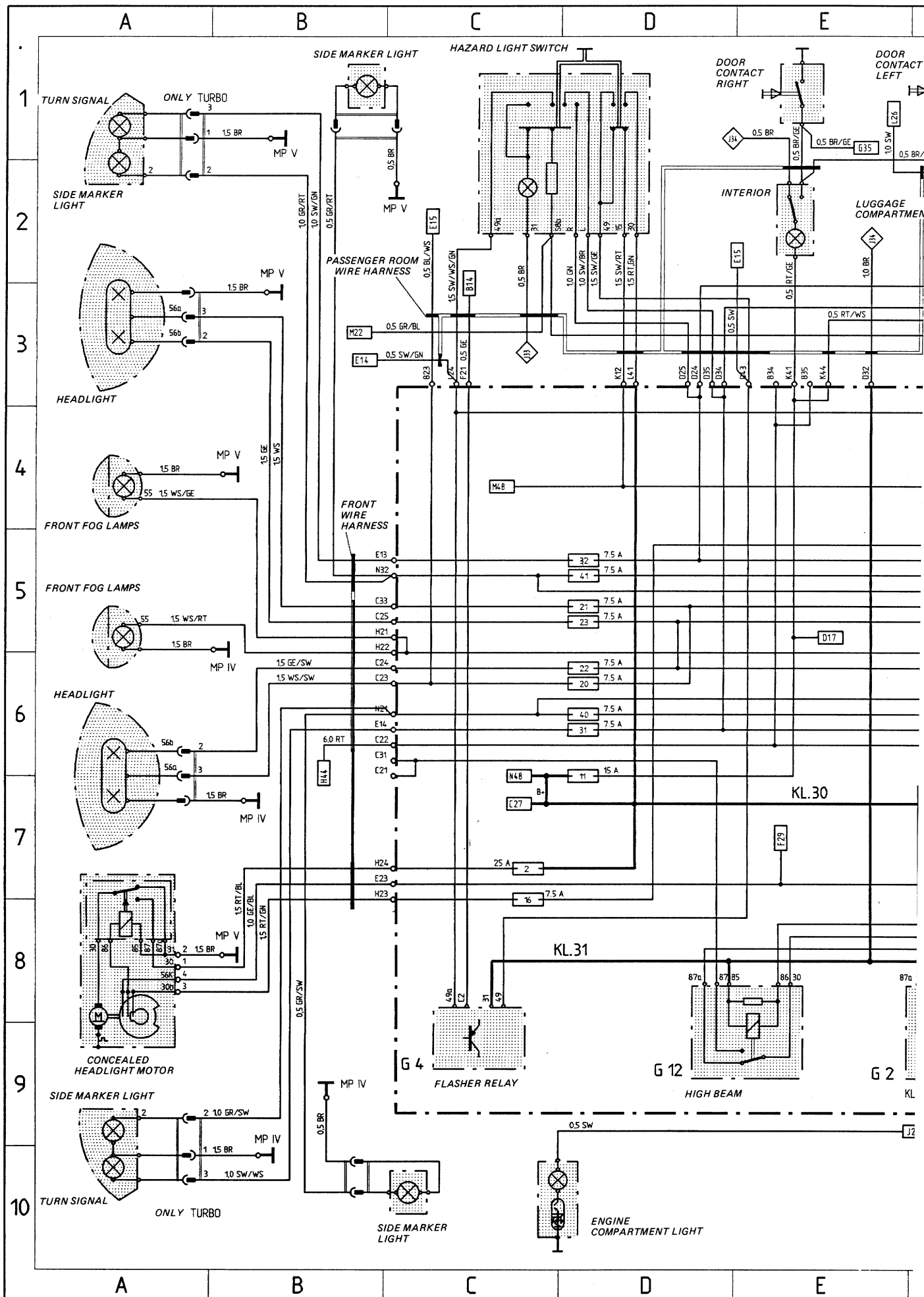

Wiring Diagram Type 944, 944 turbo, 944 S Model 87

LIGHTING USA

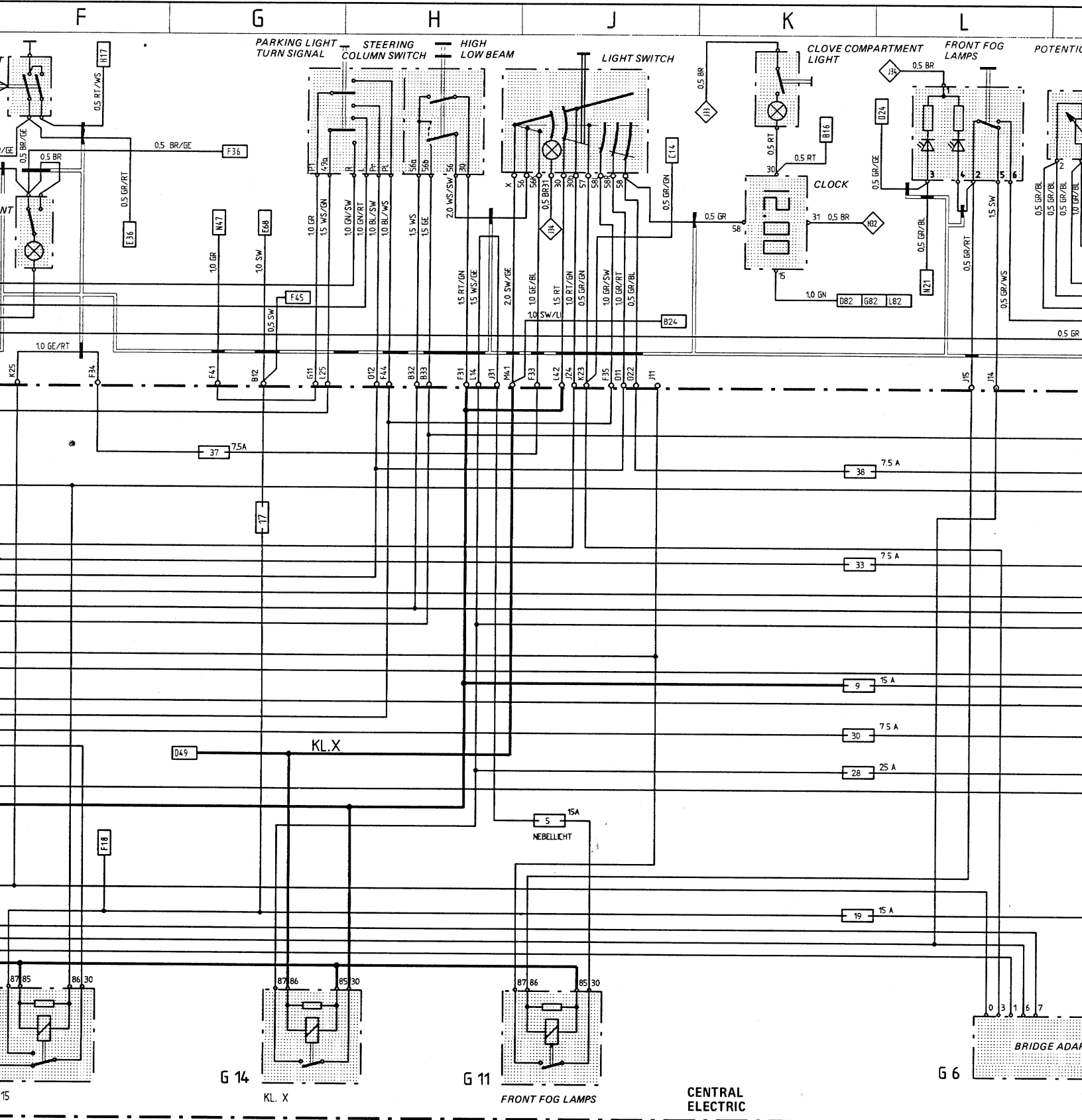



MP = GROUND TERMINALS

-  WELDING POINT
-  WELDING POINT CONNECTION WITH FIELD INDICATION
-  CONNECTION WITH FIELD INDICATION
- MP GROUND TERMINALS

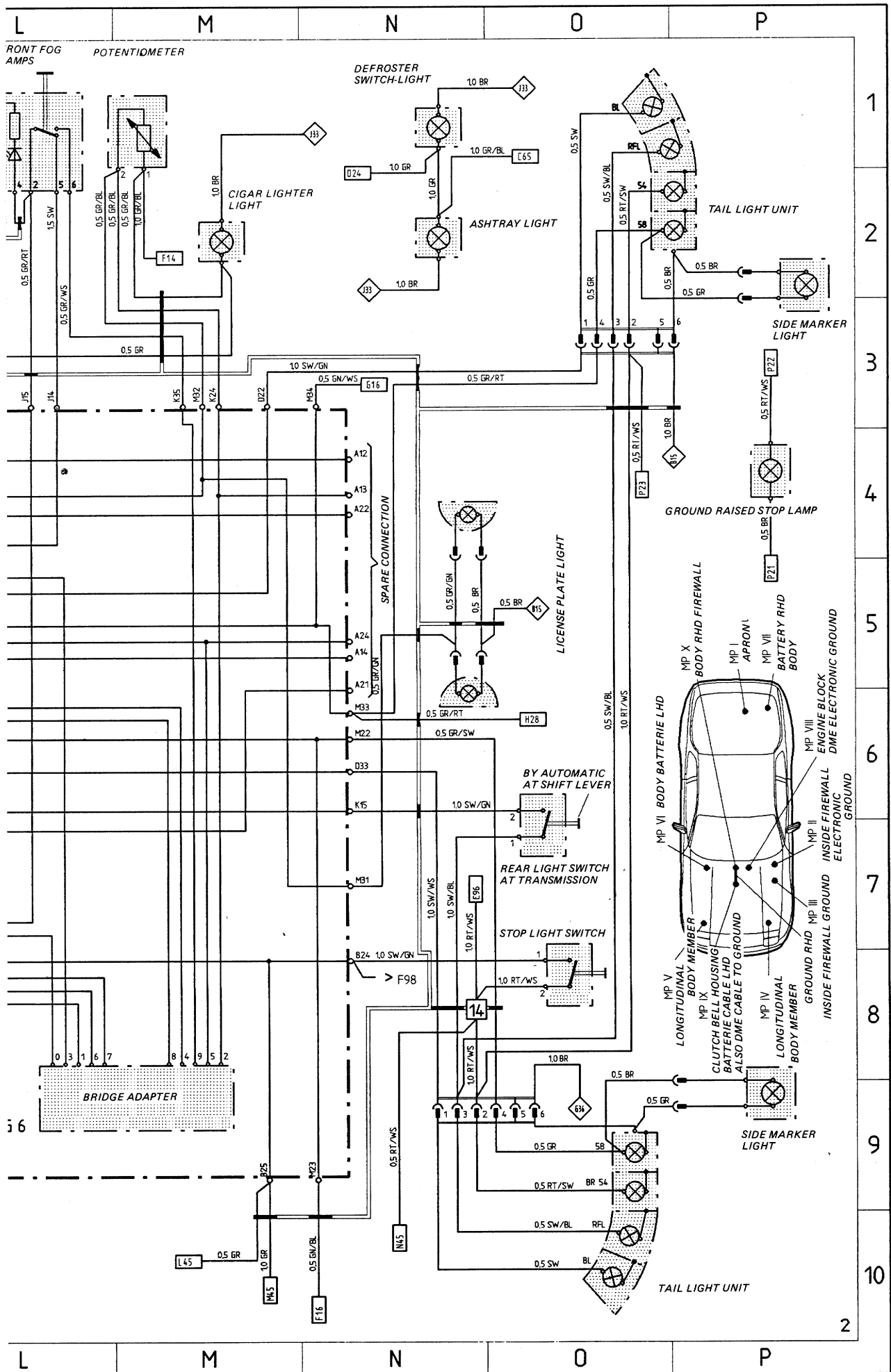

Wiring Diagram Type 944, 944 turbo 944 S Model 87 Sheet 3

INSTRUMENT CLUSTER AND SENSORS
ROW

Wiring Diagram Type 944, 944 turbo, 944 S Model 87 She

INSTRUMENT CLUSTER AND SENSORS ROW

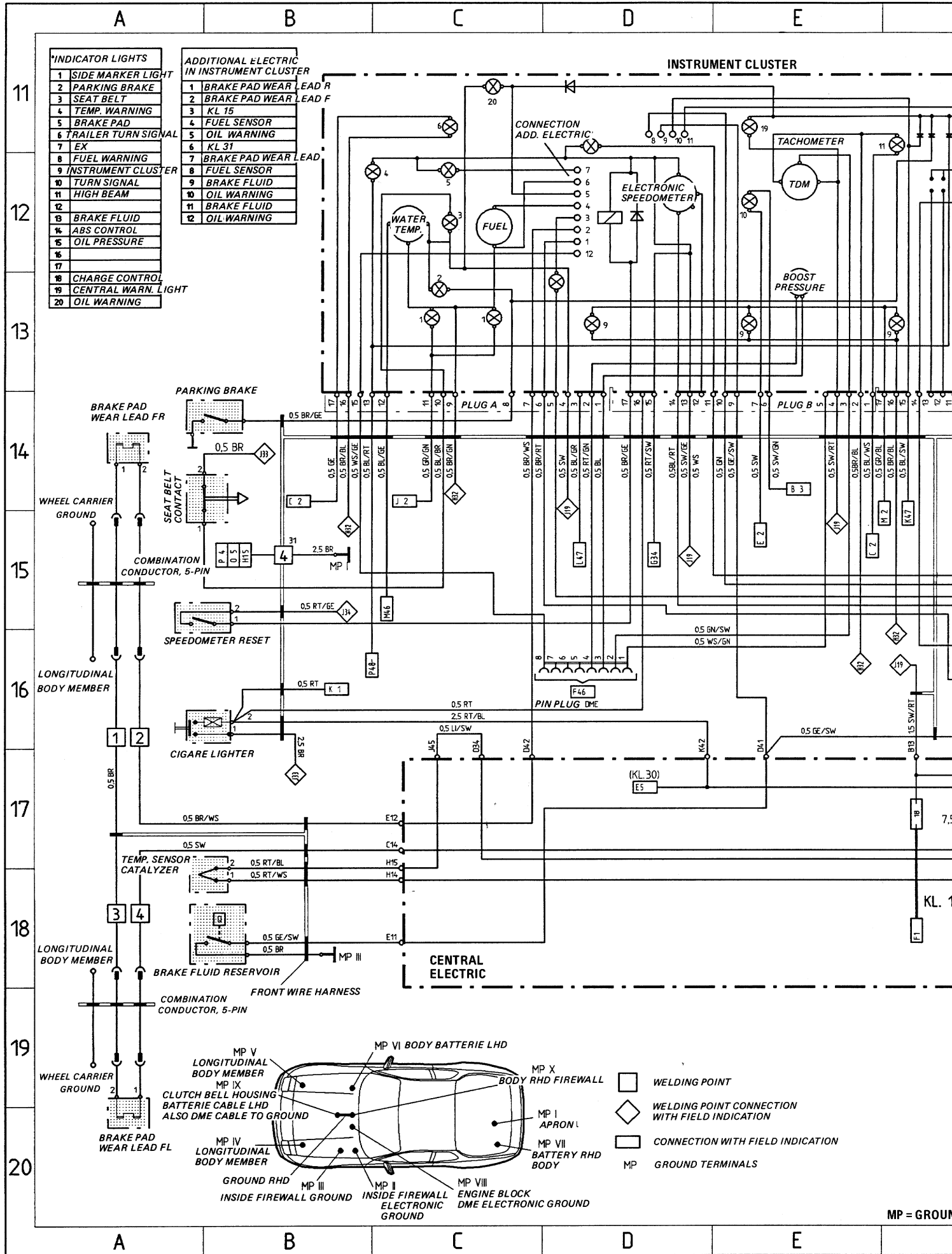

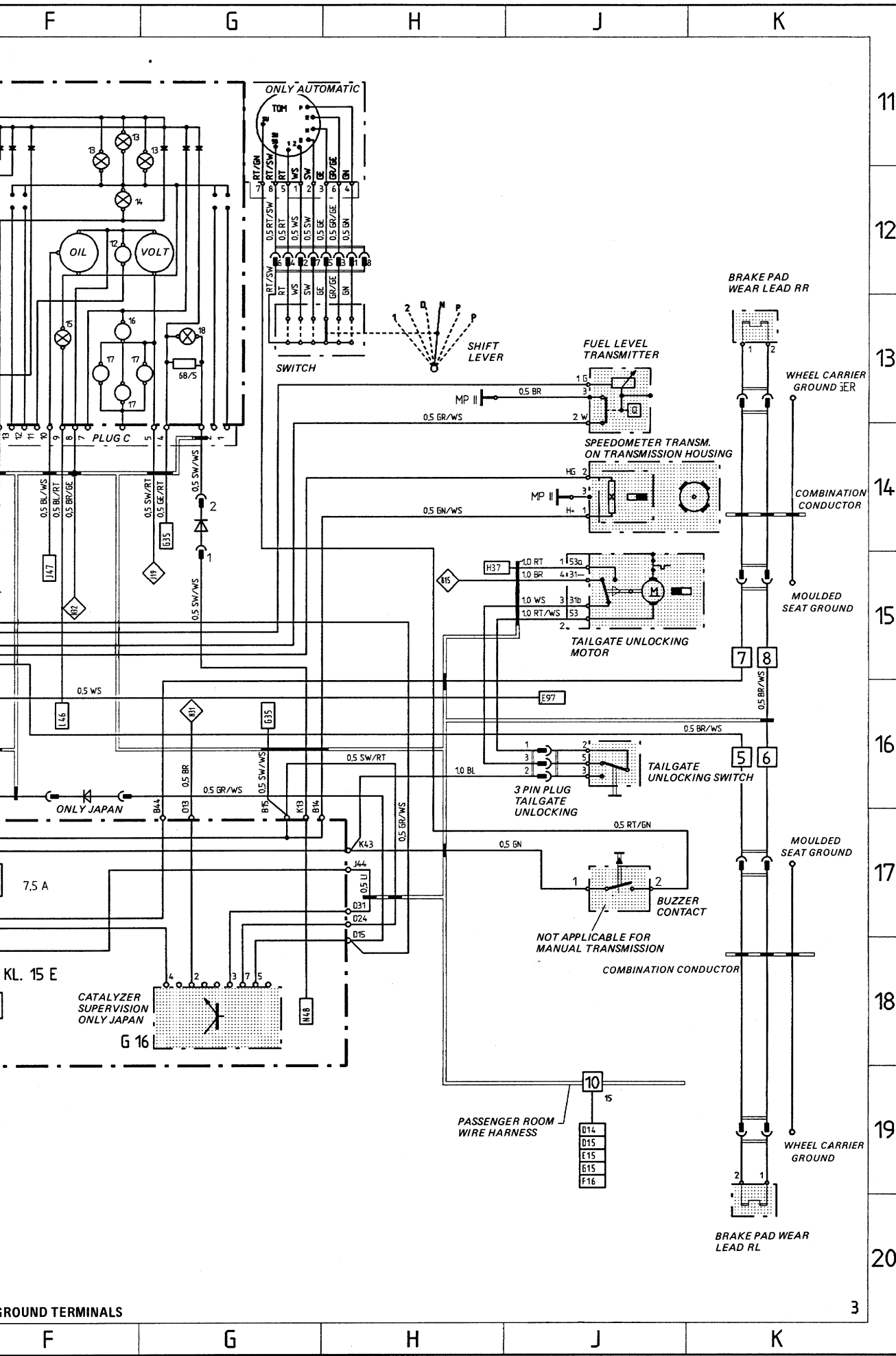

GROUND TERMINALS

Wiring Diagram Type 944, 944 turbo 944 S Model 87 Sheet 4

INSTRUMENT CLUSTER AND SENSORS
USA/SA

Wiring Diagram Type 944, 944 turbo, 944 S Model 87 She

INSTRUMENT CLUSTER AND SENSORS USA/SA

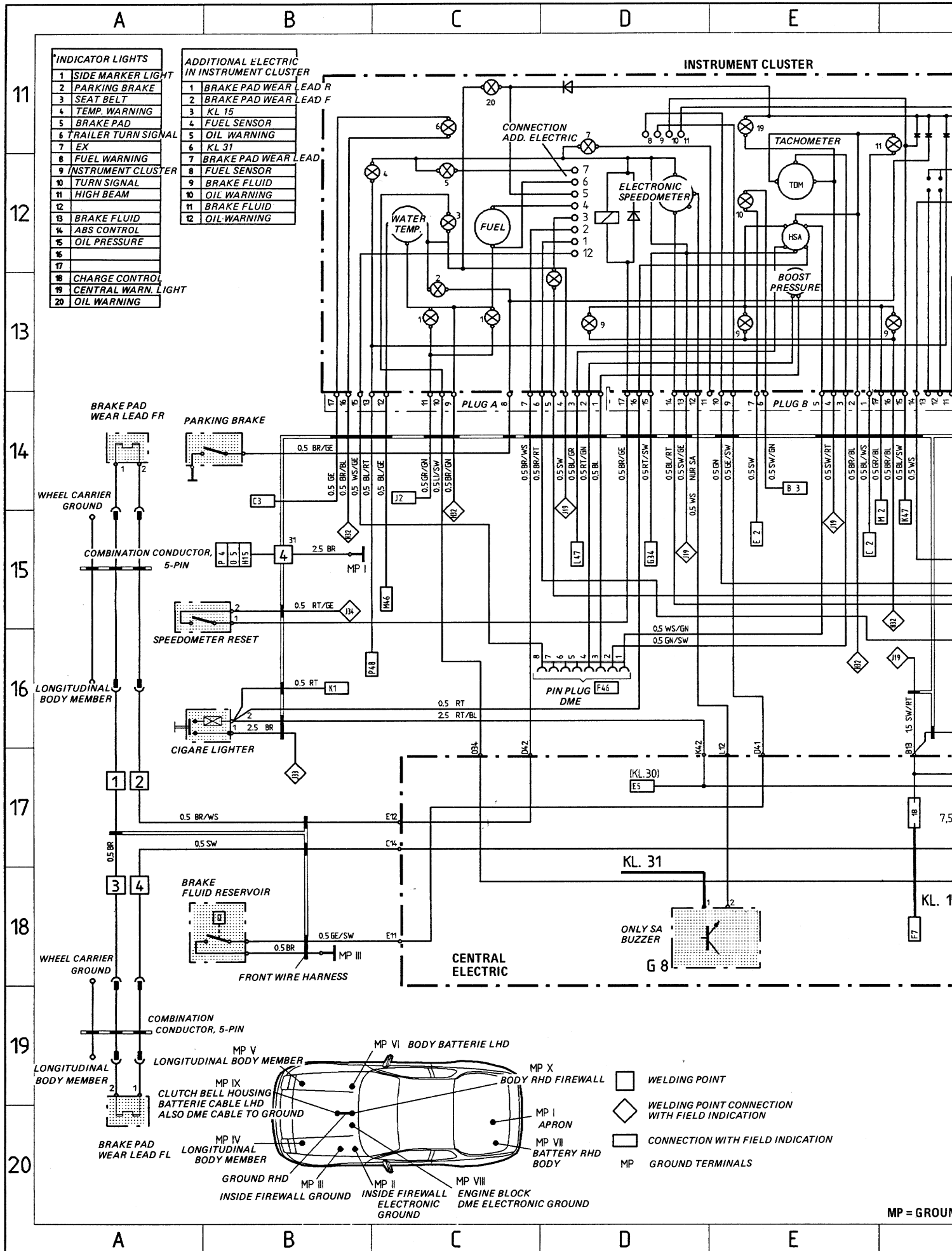

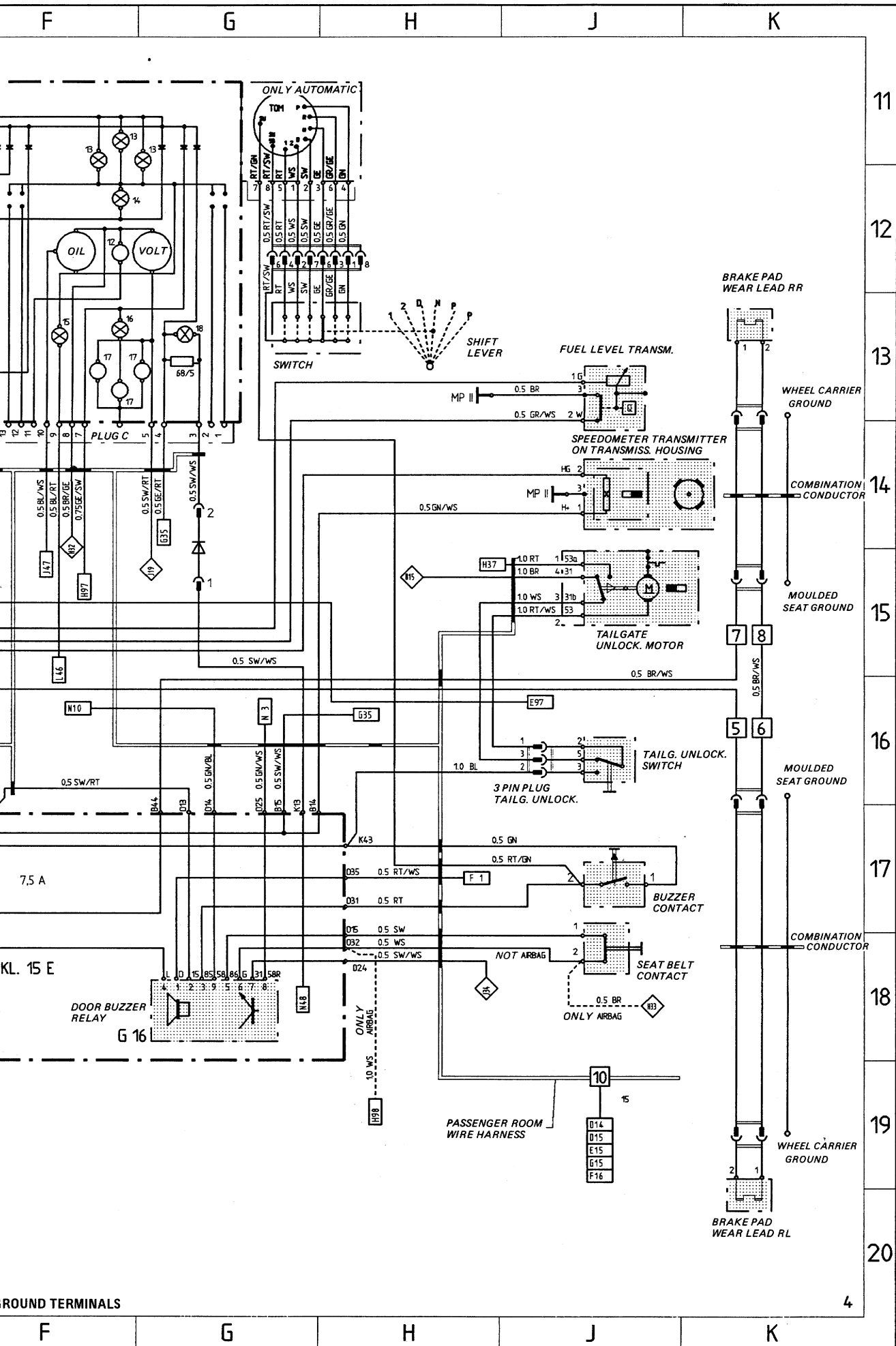

GROUND TERMINALS

4

Wiring Diagram Type 944, 944 turbo 944 S Model 87 Sheet 5

HEATING, A/C, VENTILATION, ELECTR.
SEATS, WIPER AND WASHER SYSTEM

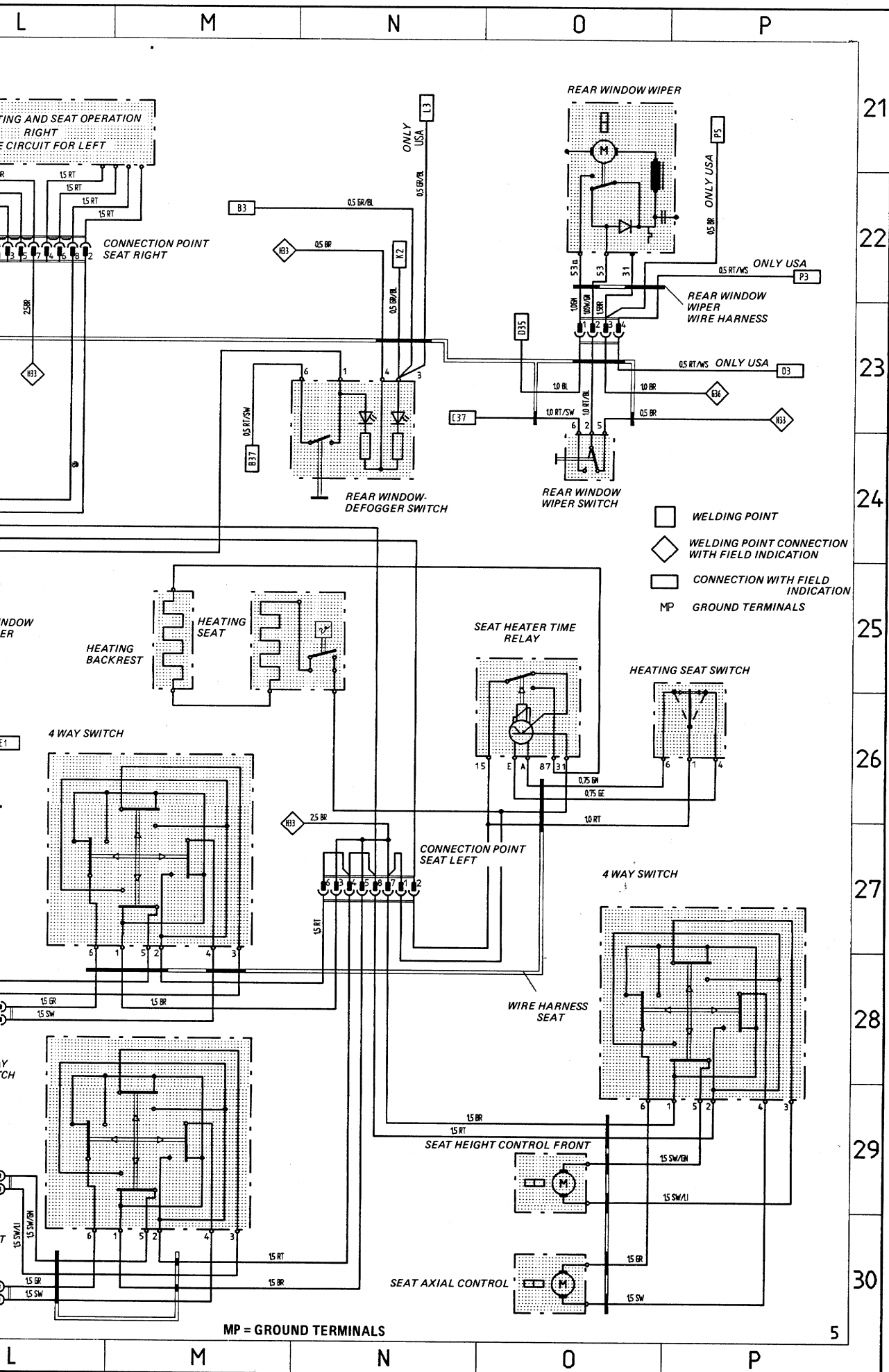

Wiring Diagram Type 944, 944 turbo 944 S Model 87 Sheet 6

HORNS, MIRRORS, WINDOW LIFTERS,
ALARM SYSTEM, TILTING ROOF

Wiring Diagram Type 944, 944 turbo, 944 S Model 87 She

HORNS, MIRRORS, WINDOW LIFTERS, ALARM SYSTEM, TILTING ROOF

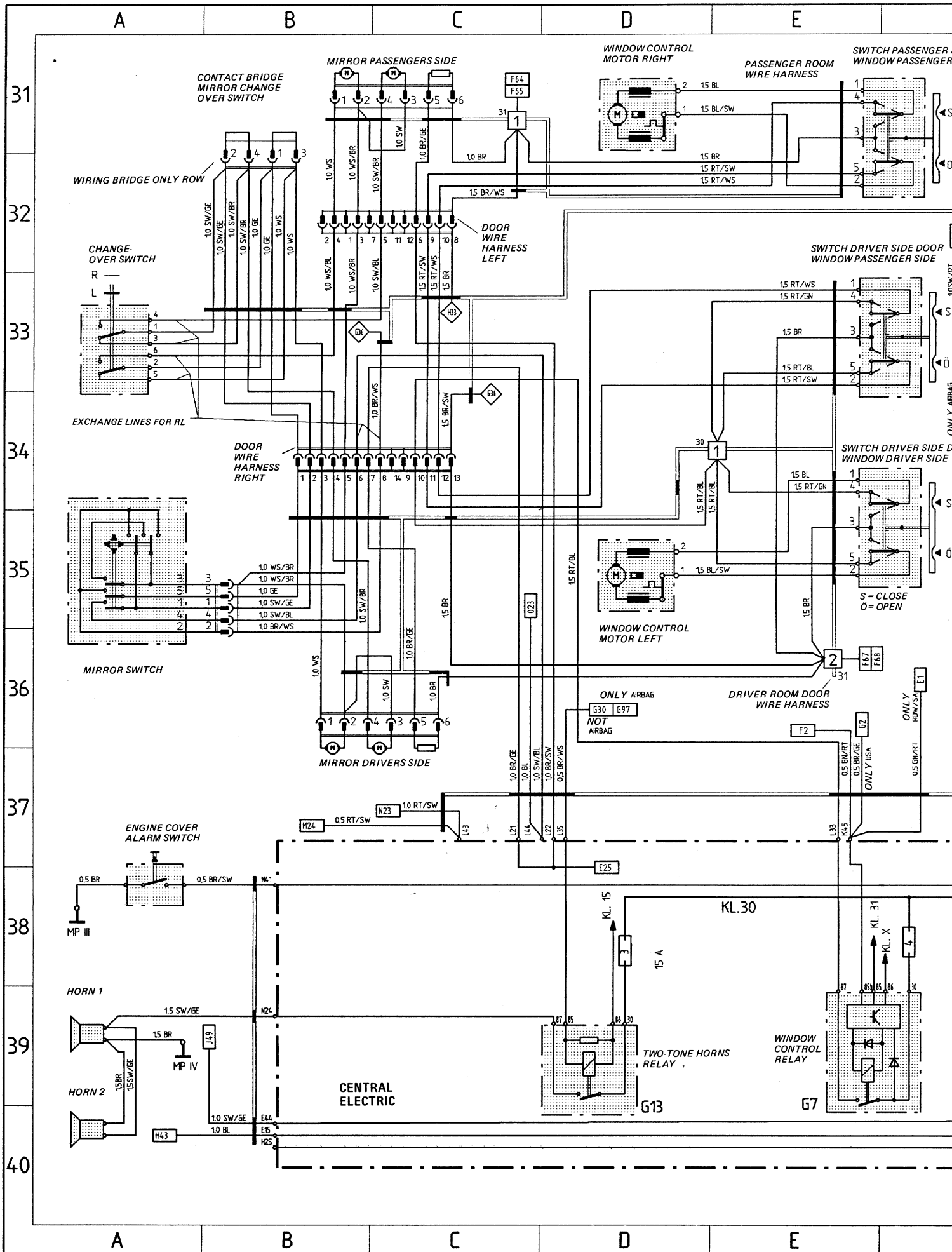

Wiring Diagram Type 944 Model 87 Sheet 7

ENGINE COMPARTMENT, TEMPOSTAT - 944

Wiring Diagram Type 944 Model 87 Sheet 7

ENGINE COMPARTMENT, TEMPOSTAT - 944

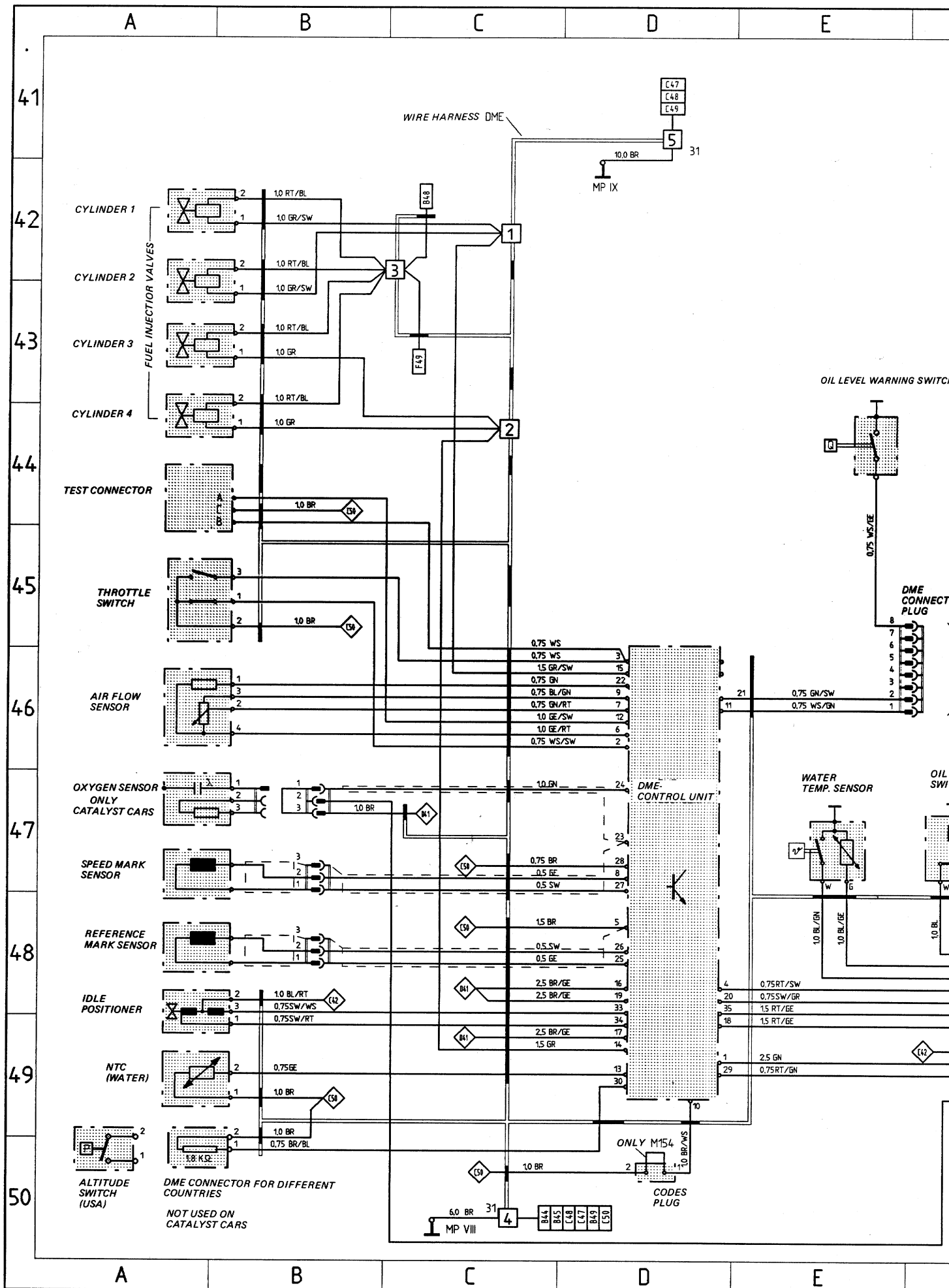

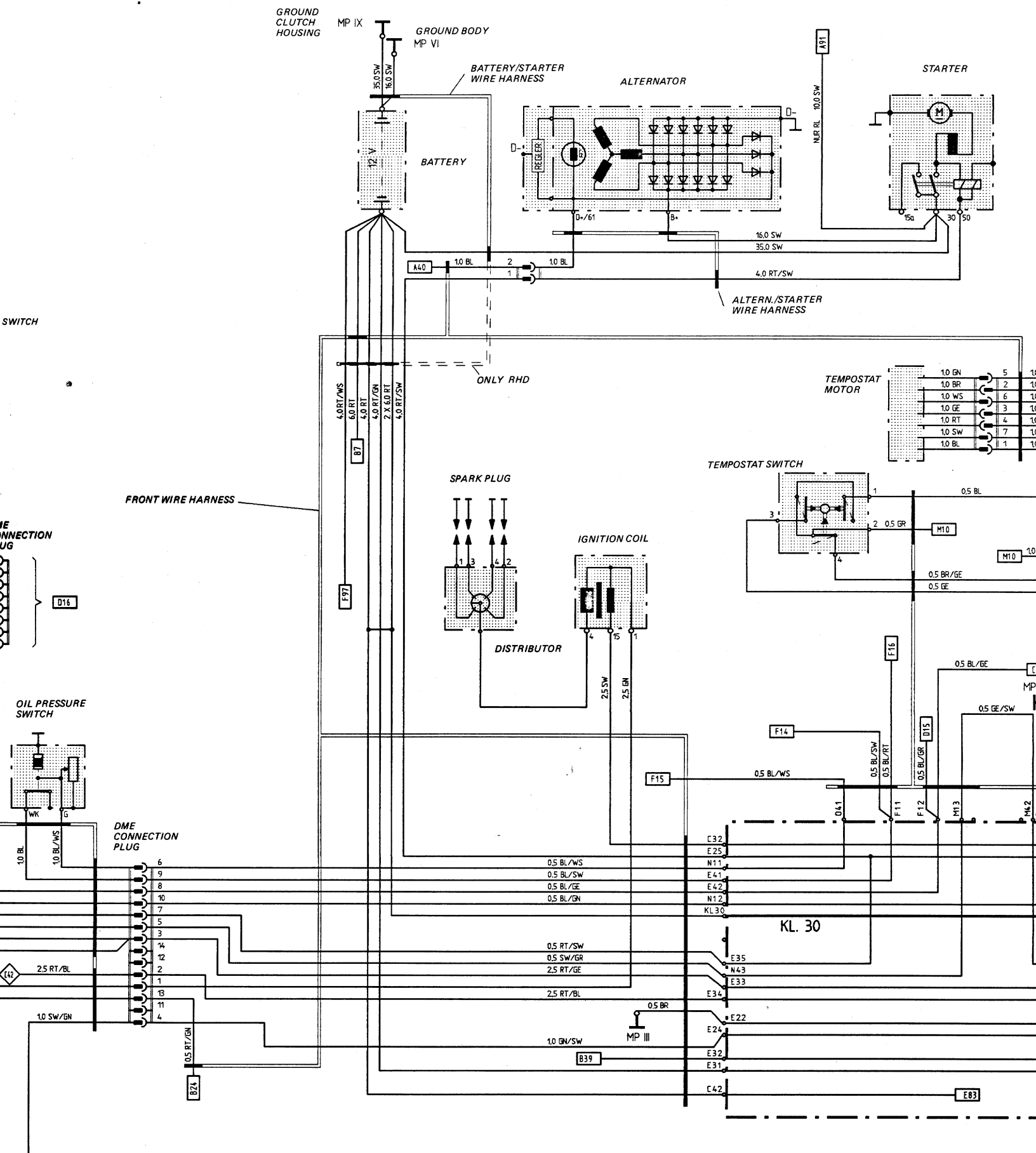

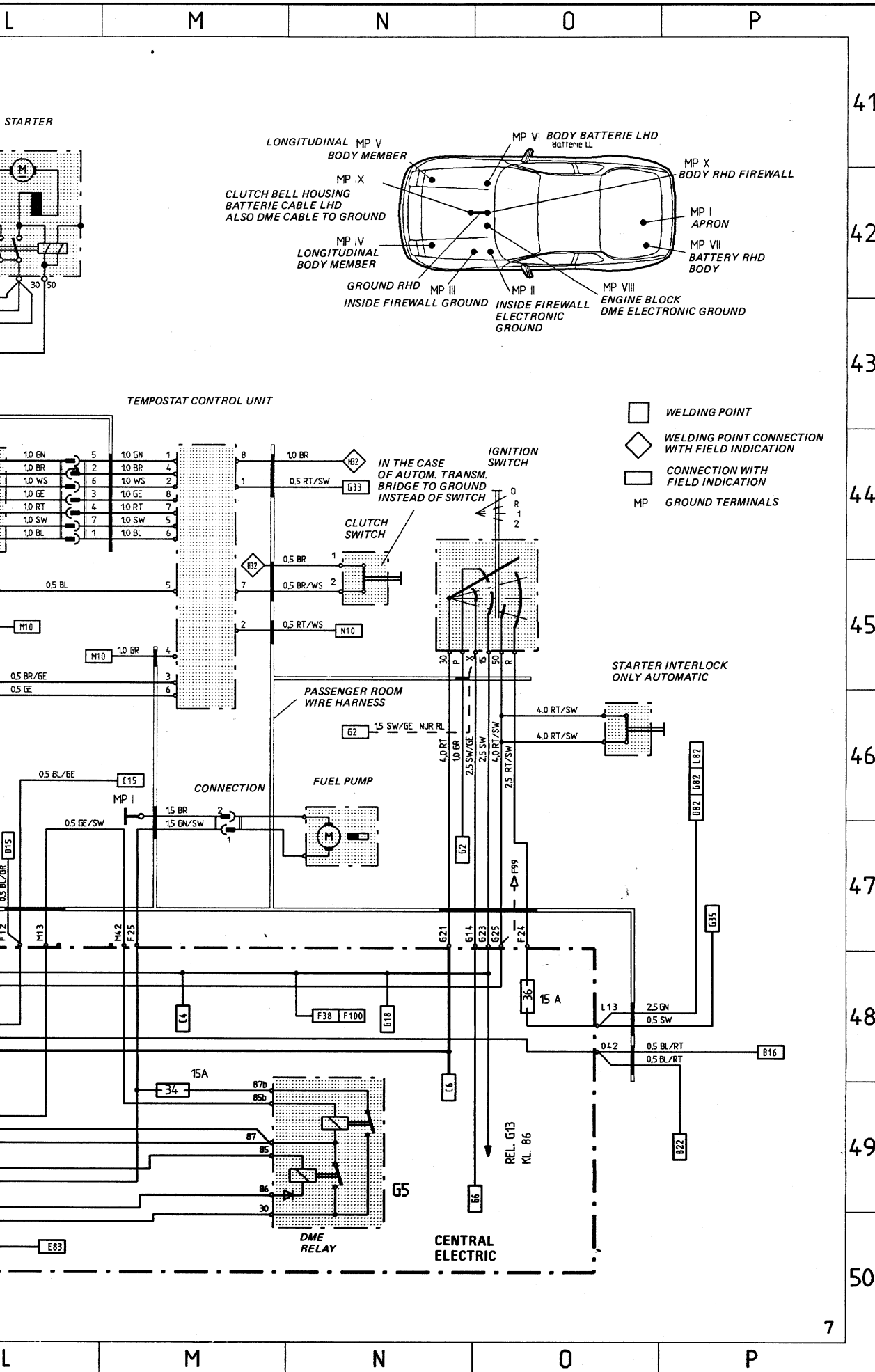

41

42

43

44

45

46

47

48

49

50

7

Wiring Diagram Type 944 turbo Model 87 Sheet 8

ENGINE COMPARTMENT, TEMPOSTAT - 944 TURBO

Wiring Diagram Type 944 turbo Model 87 Sheet 8

ENGINE COMPARTMENT, TEMPOSTAT - 944 TURBO

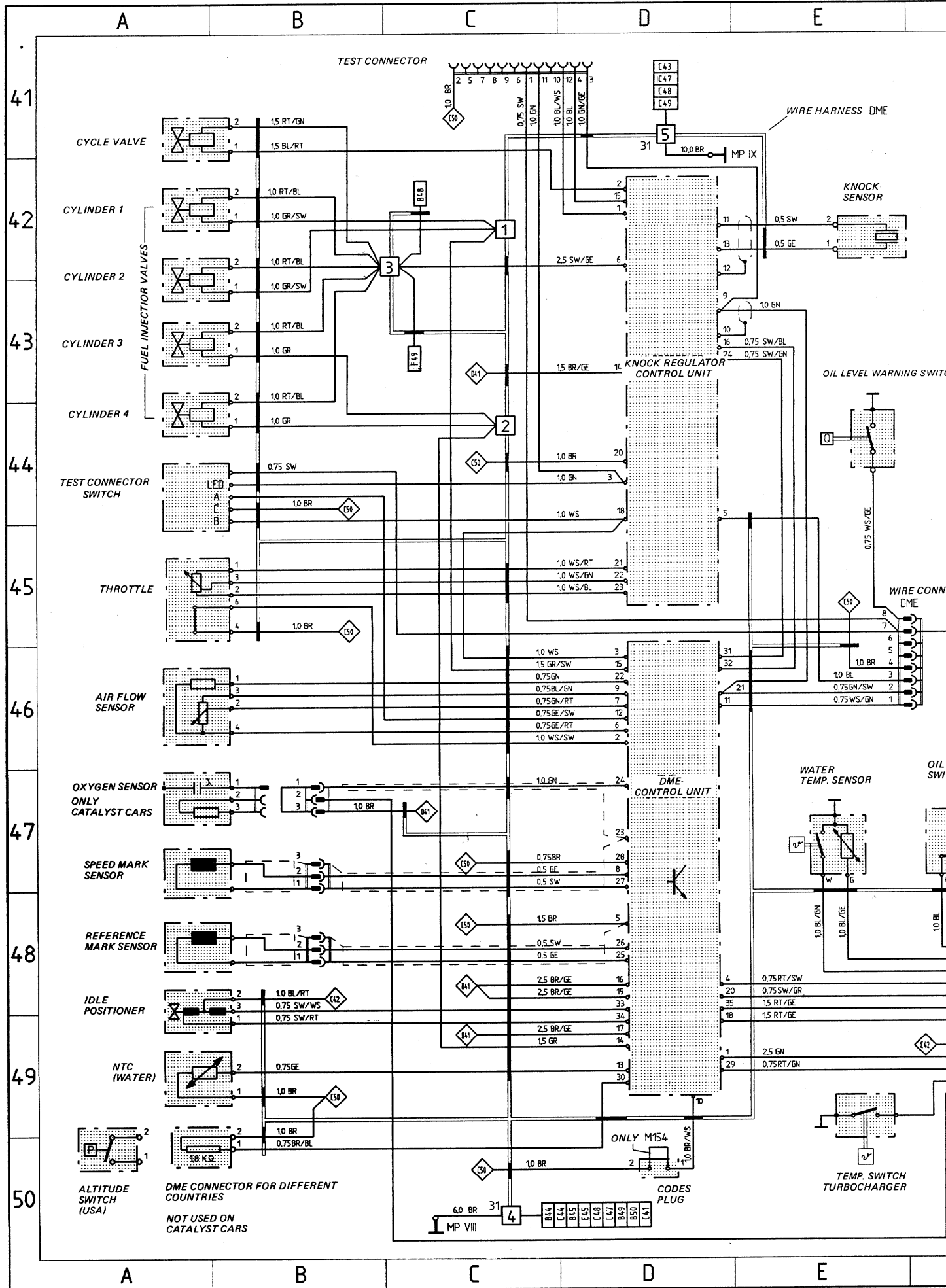

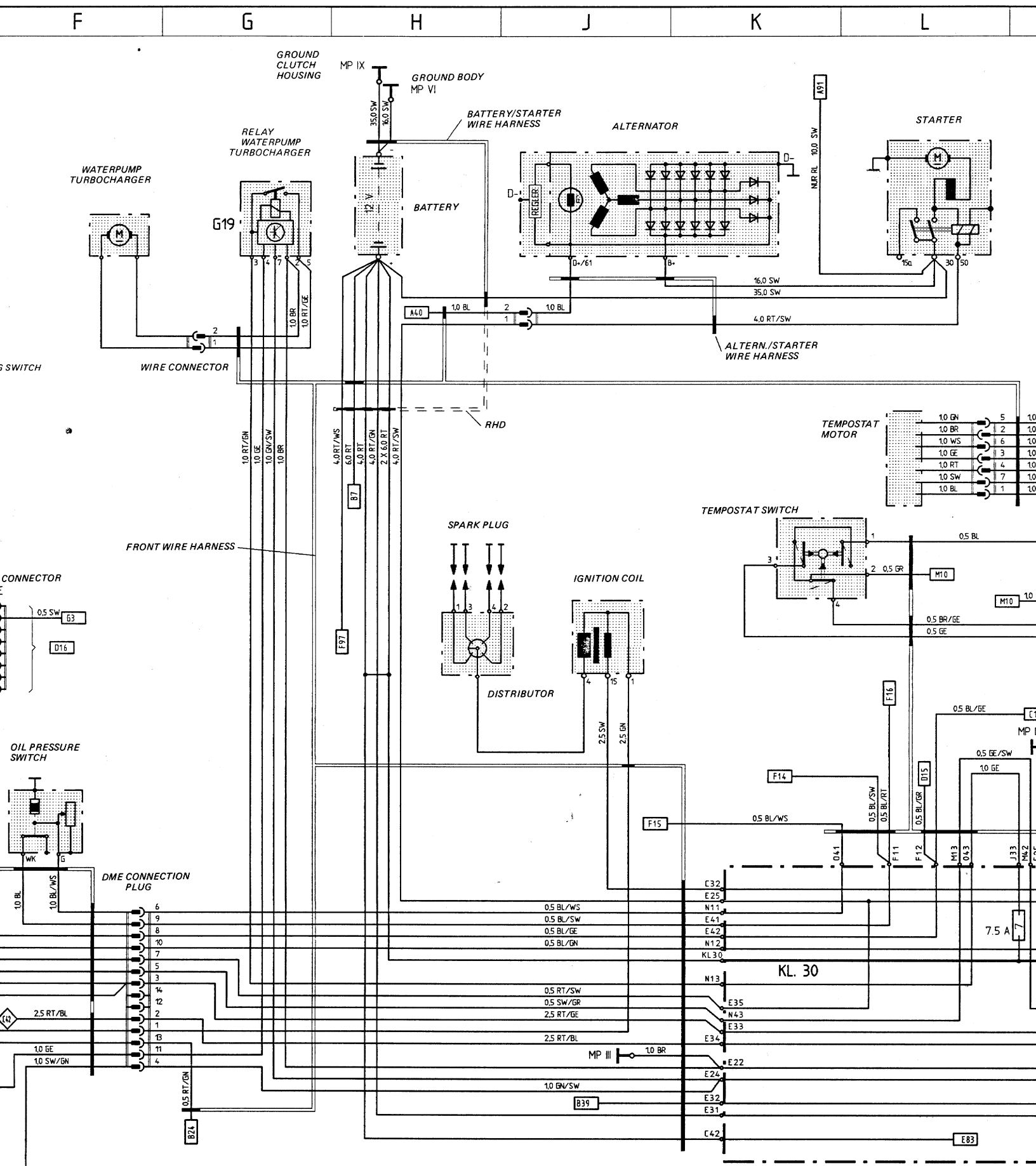

F G H J K L

F G H J K L

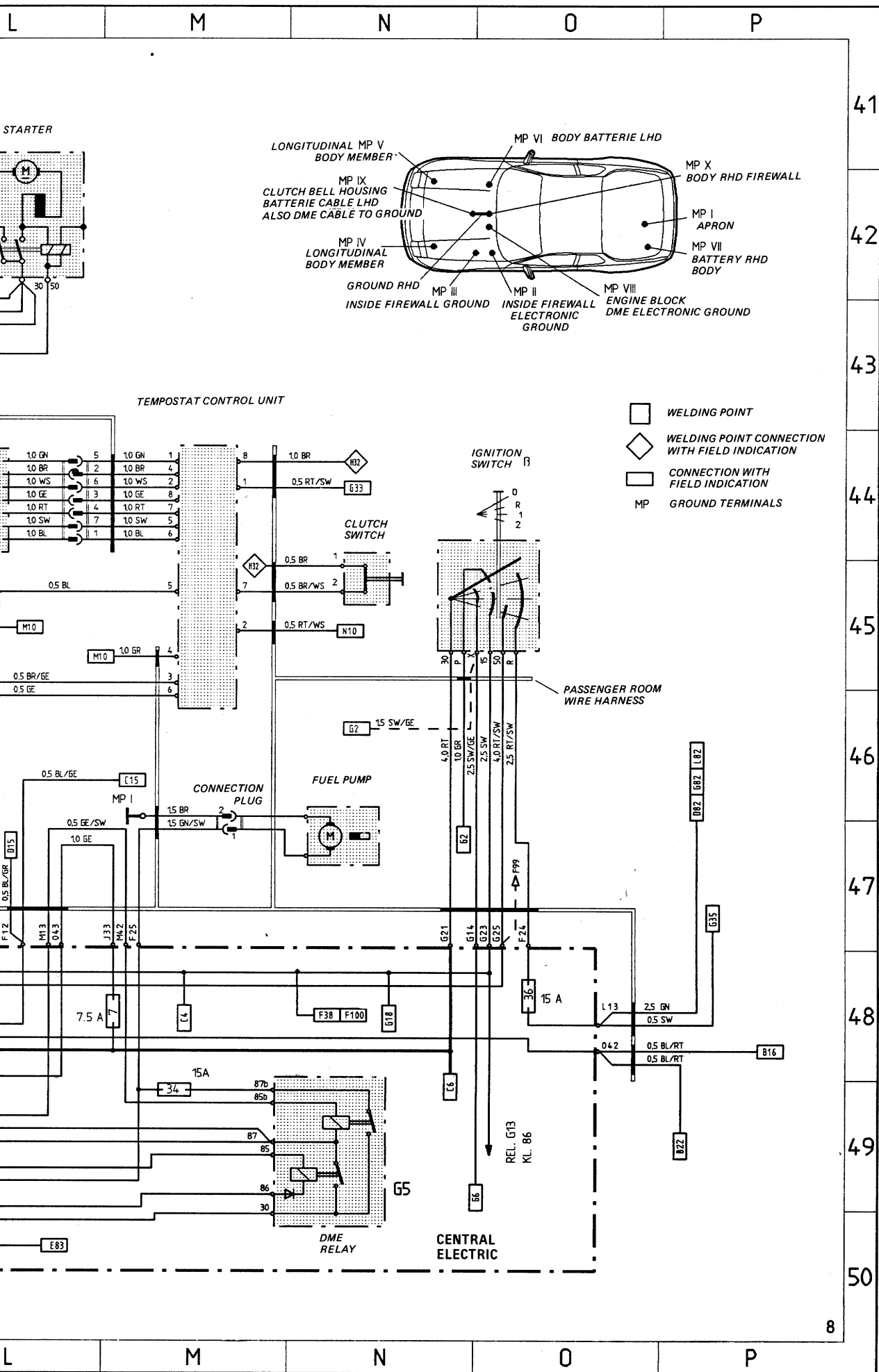

Wiring Diagram Type 944 S Model 87 Sheet 9

ENGINE COMPARTMENT, TEMPOSTAT

4-VALVES

Wiring Diagram Type 944 S Model 87 Sheet 9

ENGINE COMPARTMENT, TEMPOSTAT 4 - VALVES

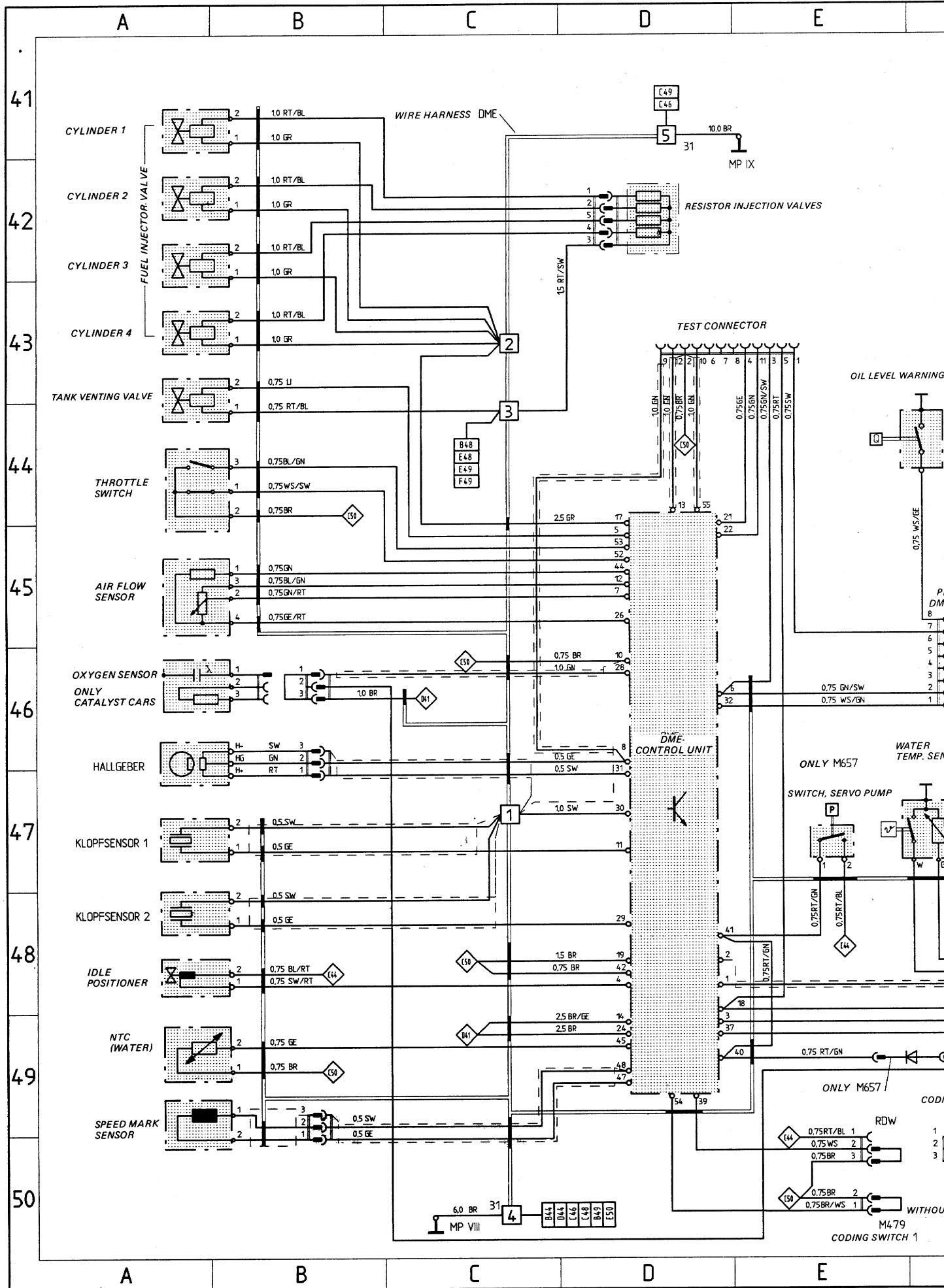

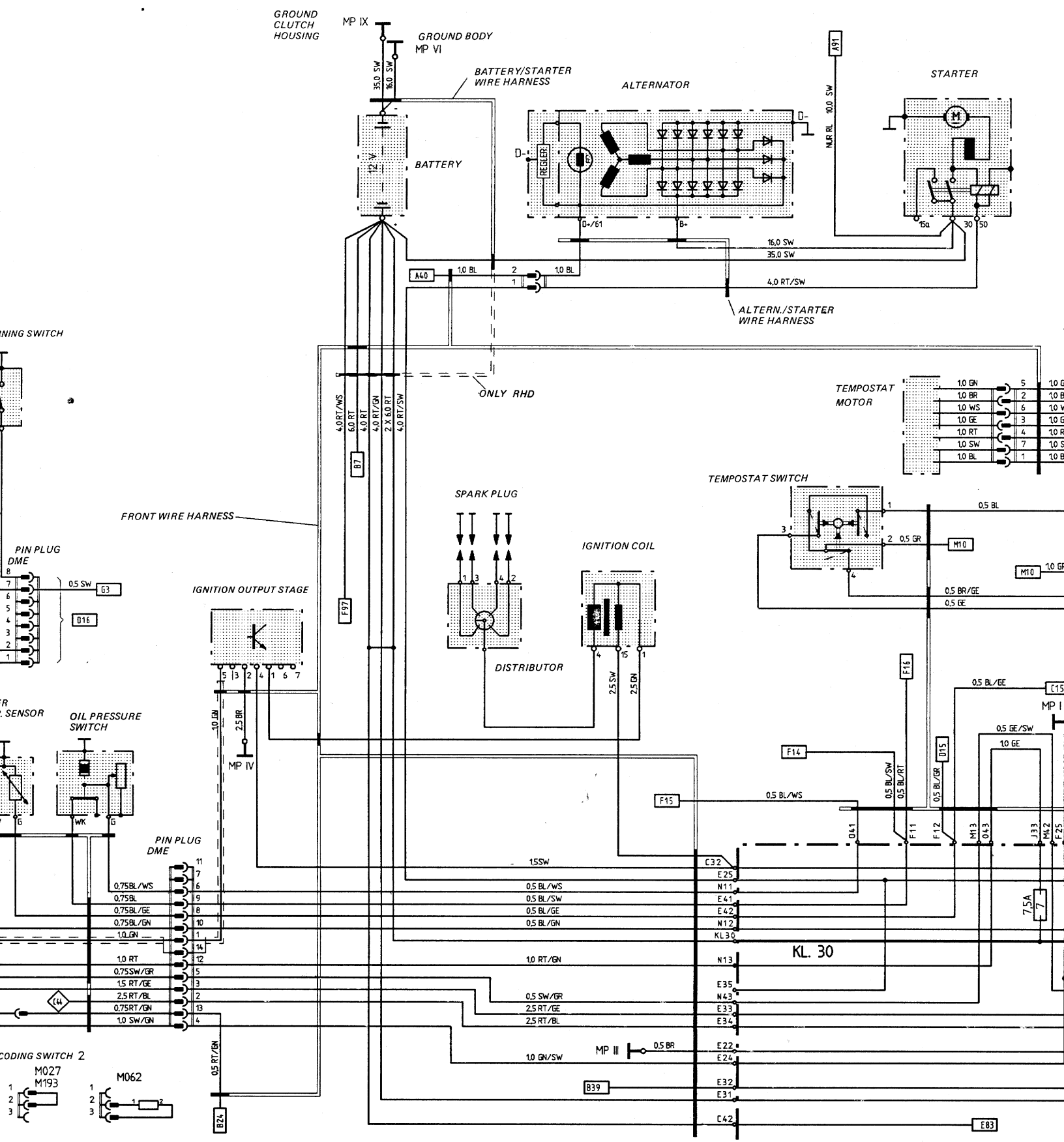

MP = GROUND TERMINALS

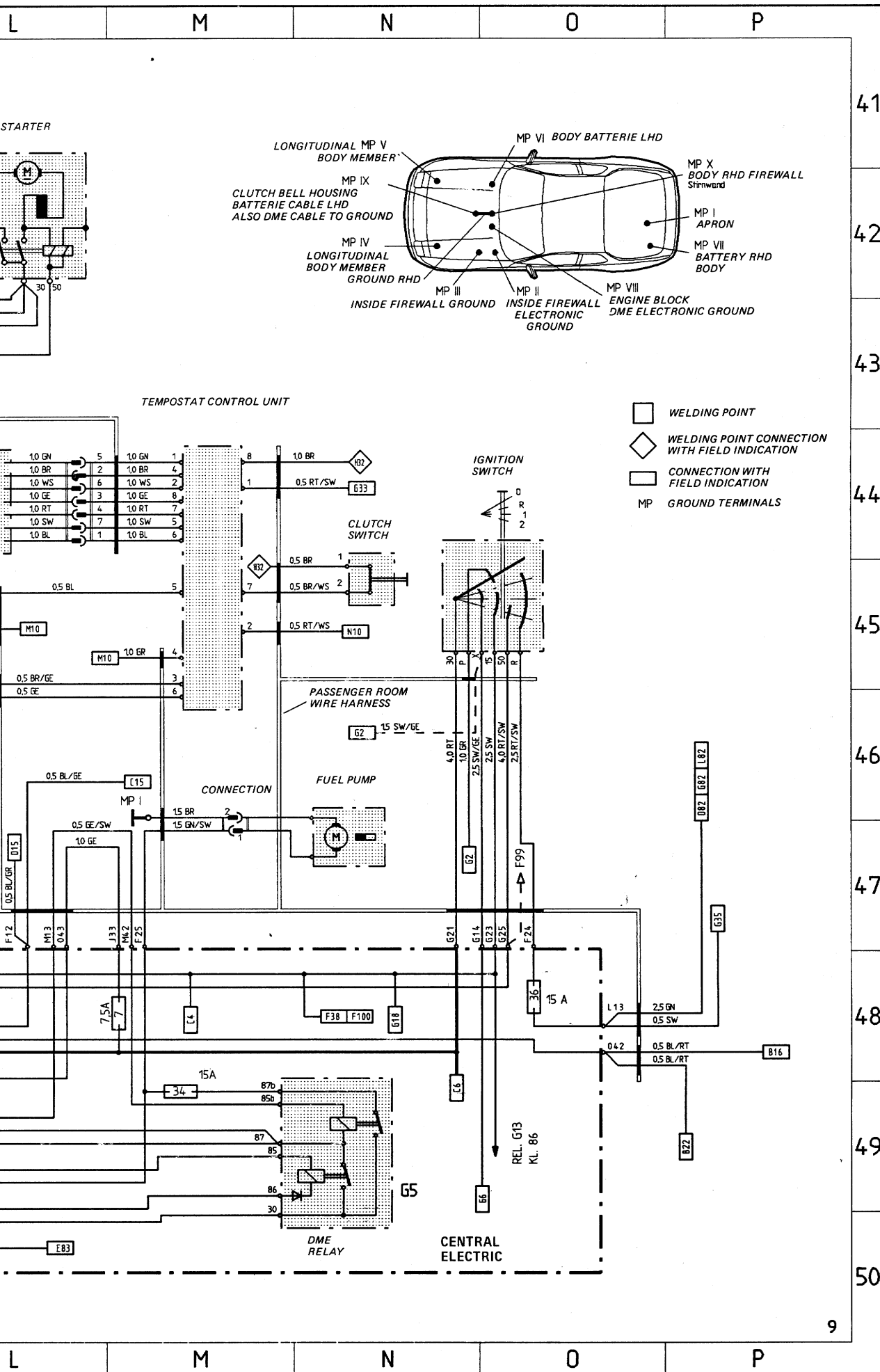

Wiring Diagram Type 944, 944 turbo 944 S Model 87 Sheet 10

CENTRAL ELECTRICAL SYSTEM

Wiring Diagram Type 944, 944 turbo, 944 S Model 87 She

CENTRAL ELECTRICAL SYSTEM

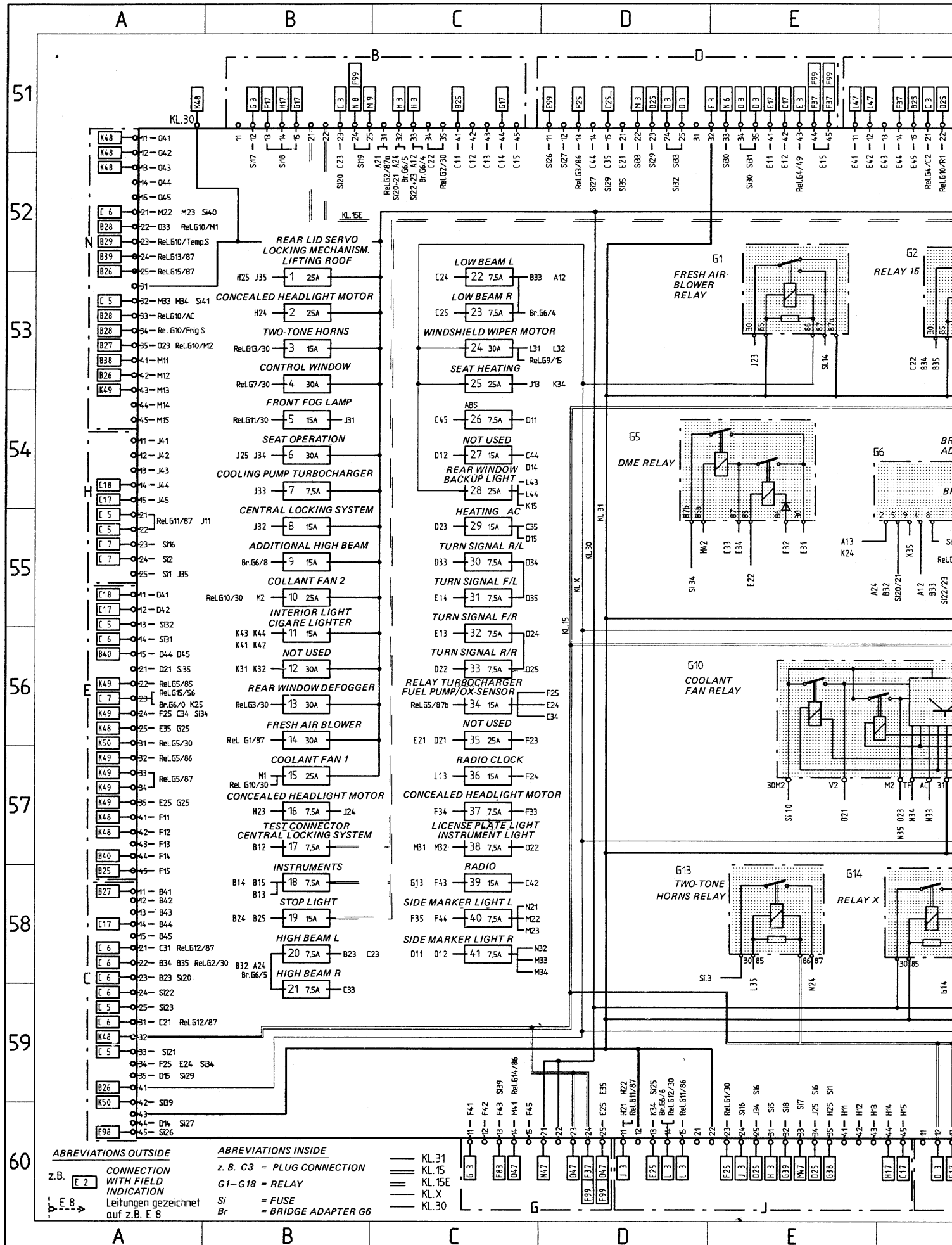

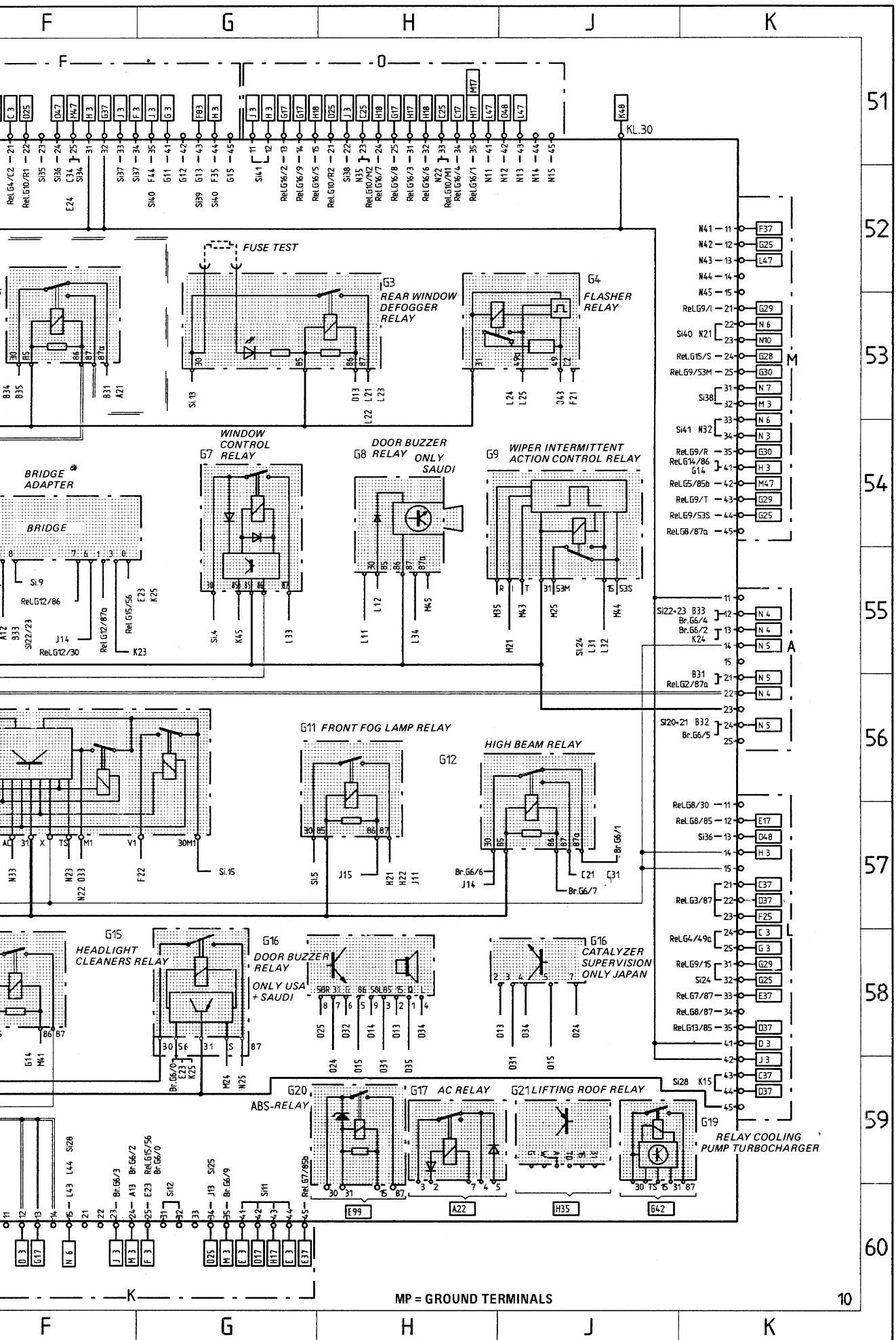

MP = GROUND TERMINALS

Wiring Diagram Type 944, 944 turbo 944 S Model 87 Sheet 11

CENTRAL LOCKING SYSTEM

Wiring Diagram Type 944, 944 turbo, 944 S Model 87 She

CENTRAL LOCKING SYSTEM

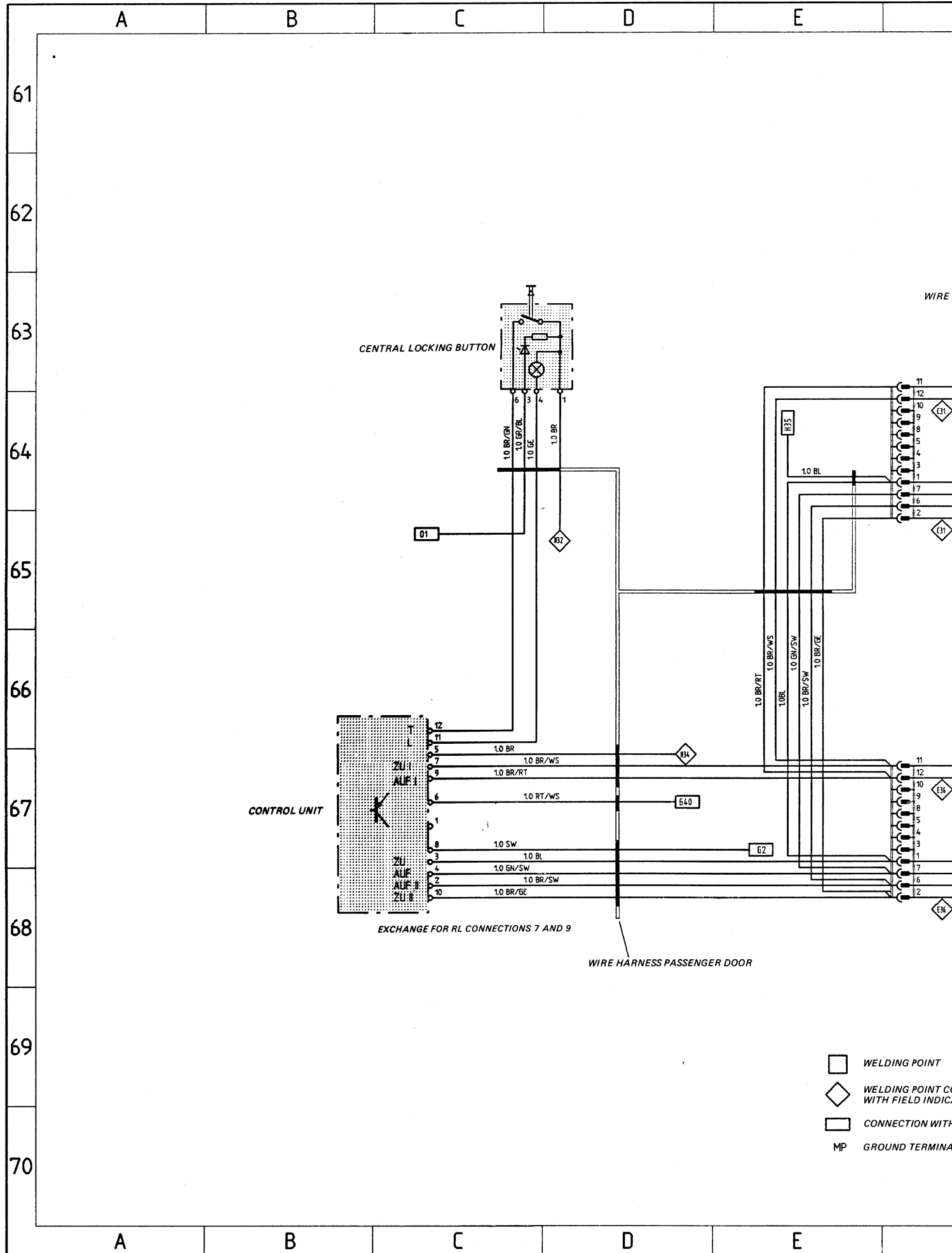

F G H J K

61

62

63

64

65

66

67

68

69

70

WIRE HARNESS PASSENGER ROOM

MICROSWITCH ON DOOR LOCK RIGHT



CONTROL MOTOR

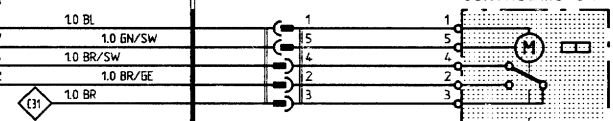

ACTIVATION VIA MAKE-CONTACT LINKAGE

MICROSWITCH ON DOOR LOCK LEFT



CONTROL MOTOR

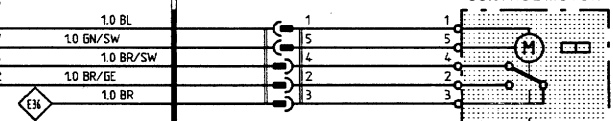

ACTIVATION VIA MAKE-CONTACT LINKAGE

WIRE HARNESS DRIVER DOOR

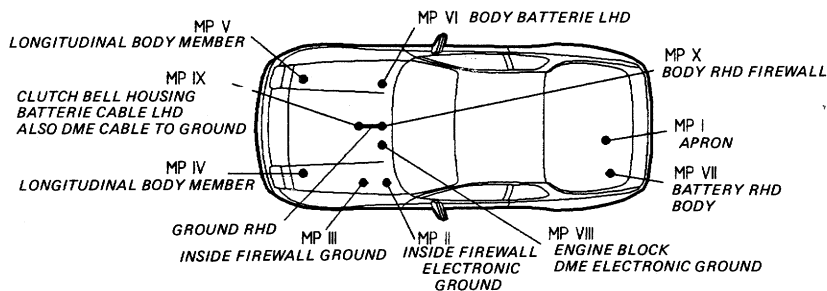

MP = GROUND TERMINALS

F G H J K

Wiring Diagram Type 944, 944 turbo 944 S Model 87 Sheet 12

FOG LIGHT, FOG TAIL LIGHT

Wiring Diagram Type 944, 944 turbo, 944 S Model 87 SH

FOG LIGHT, FOG TAIL LIGHT

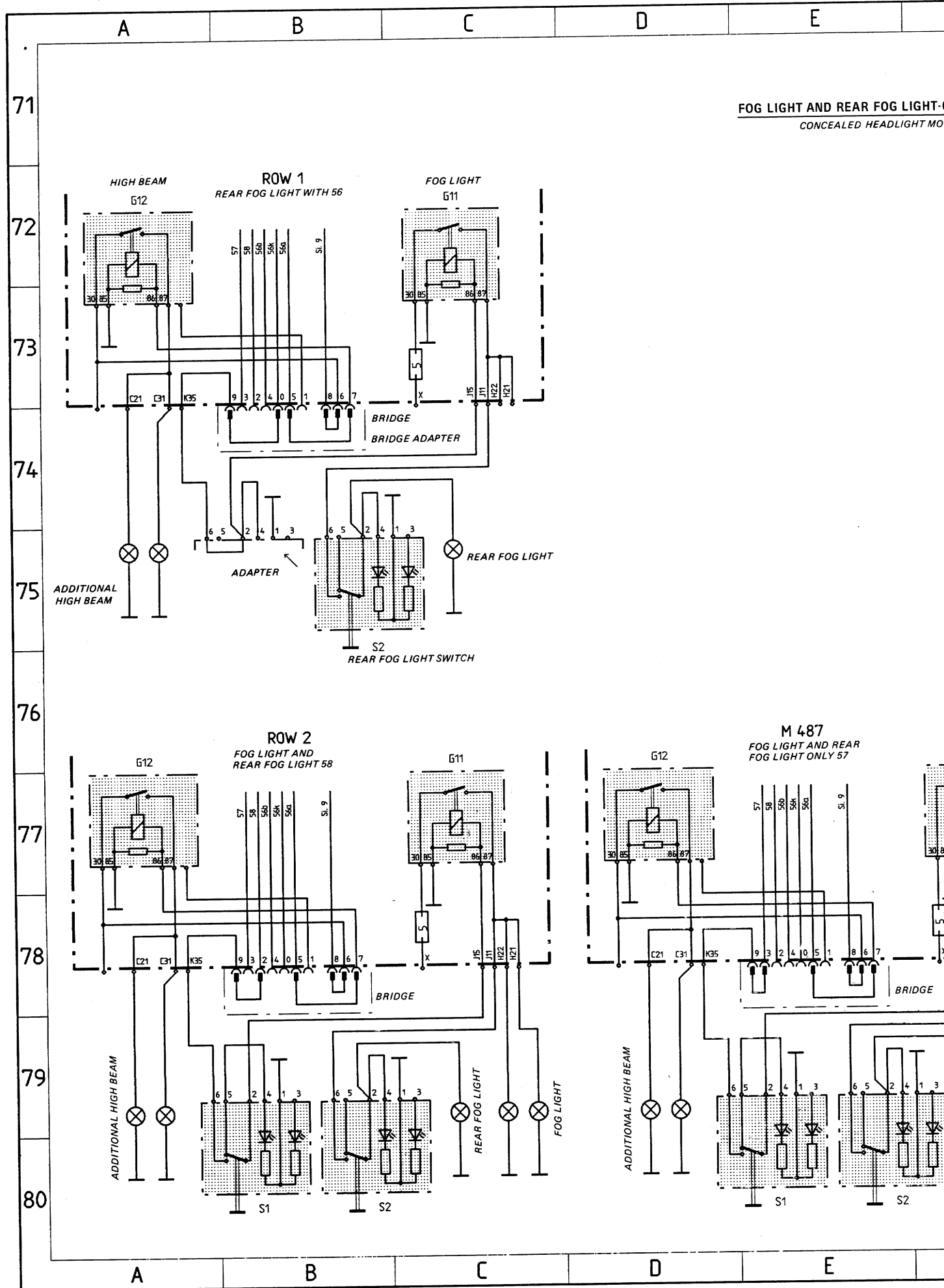

F G H J K L

LIGHT-CIRCUIT
LIGHT MOTOR

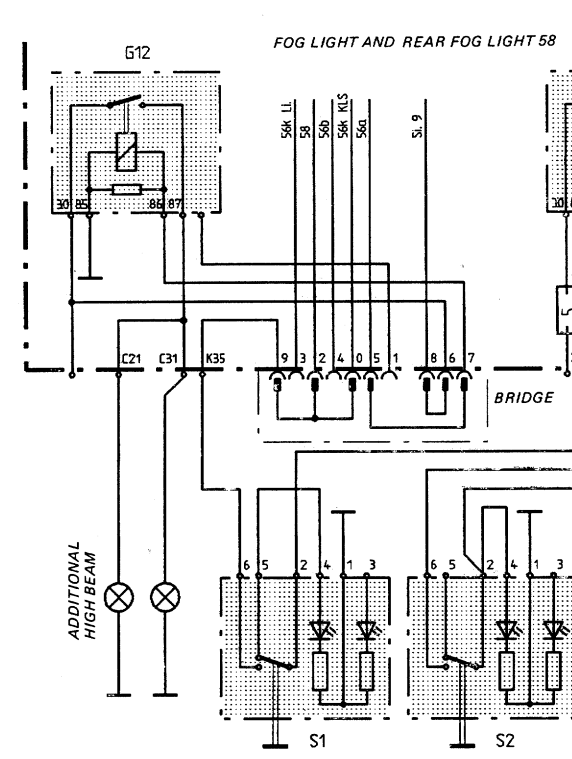
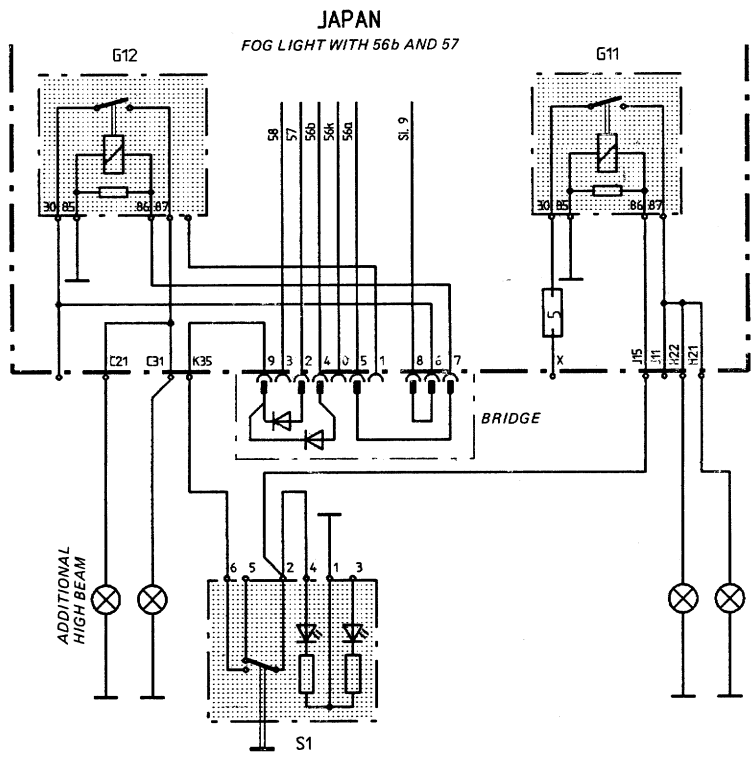
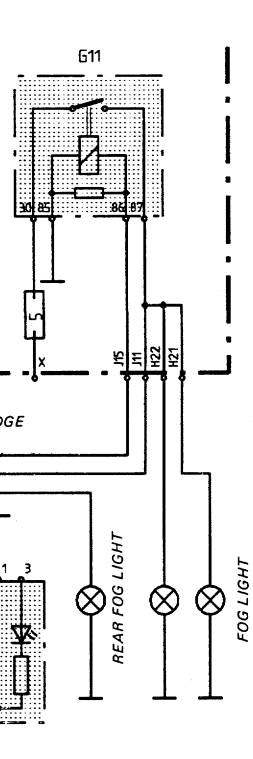
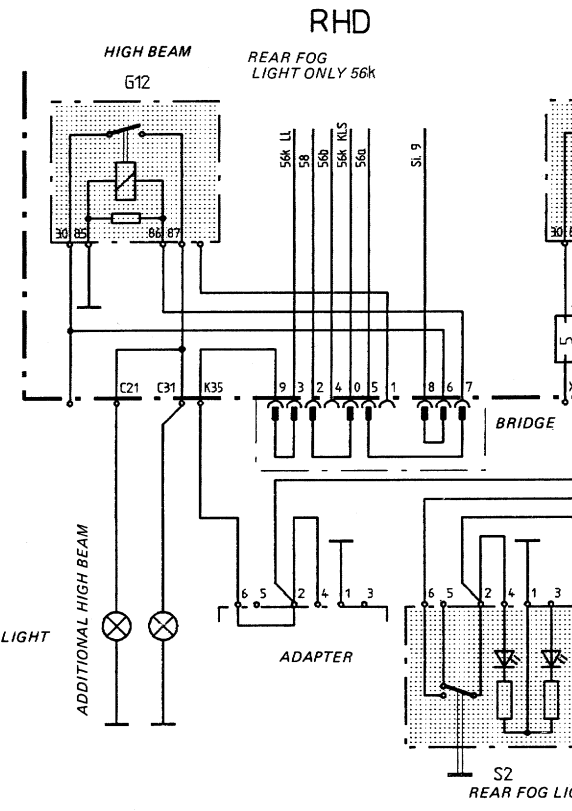
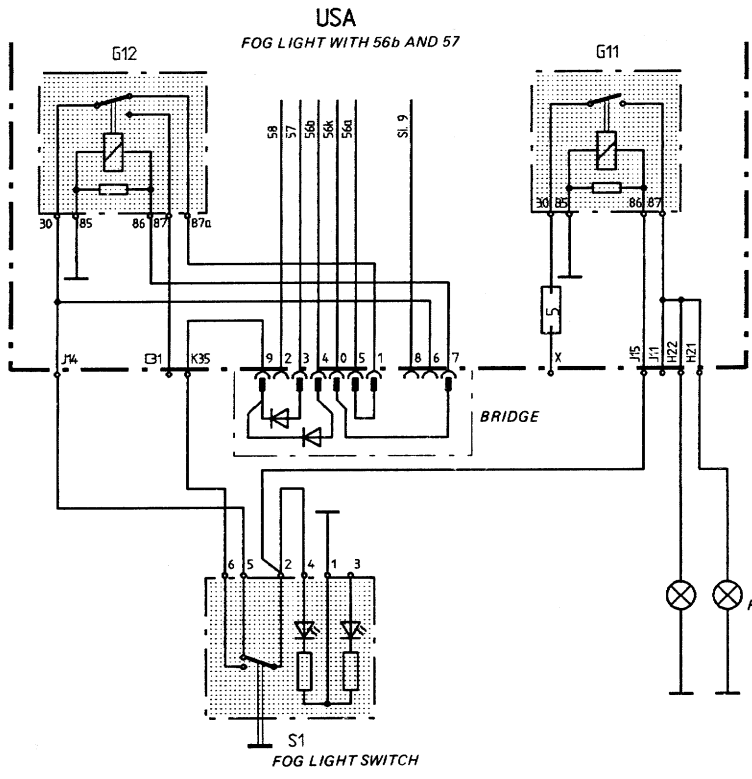

F G H J K L

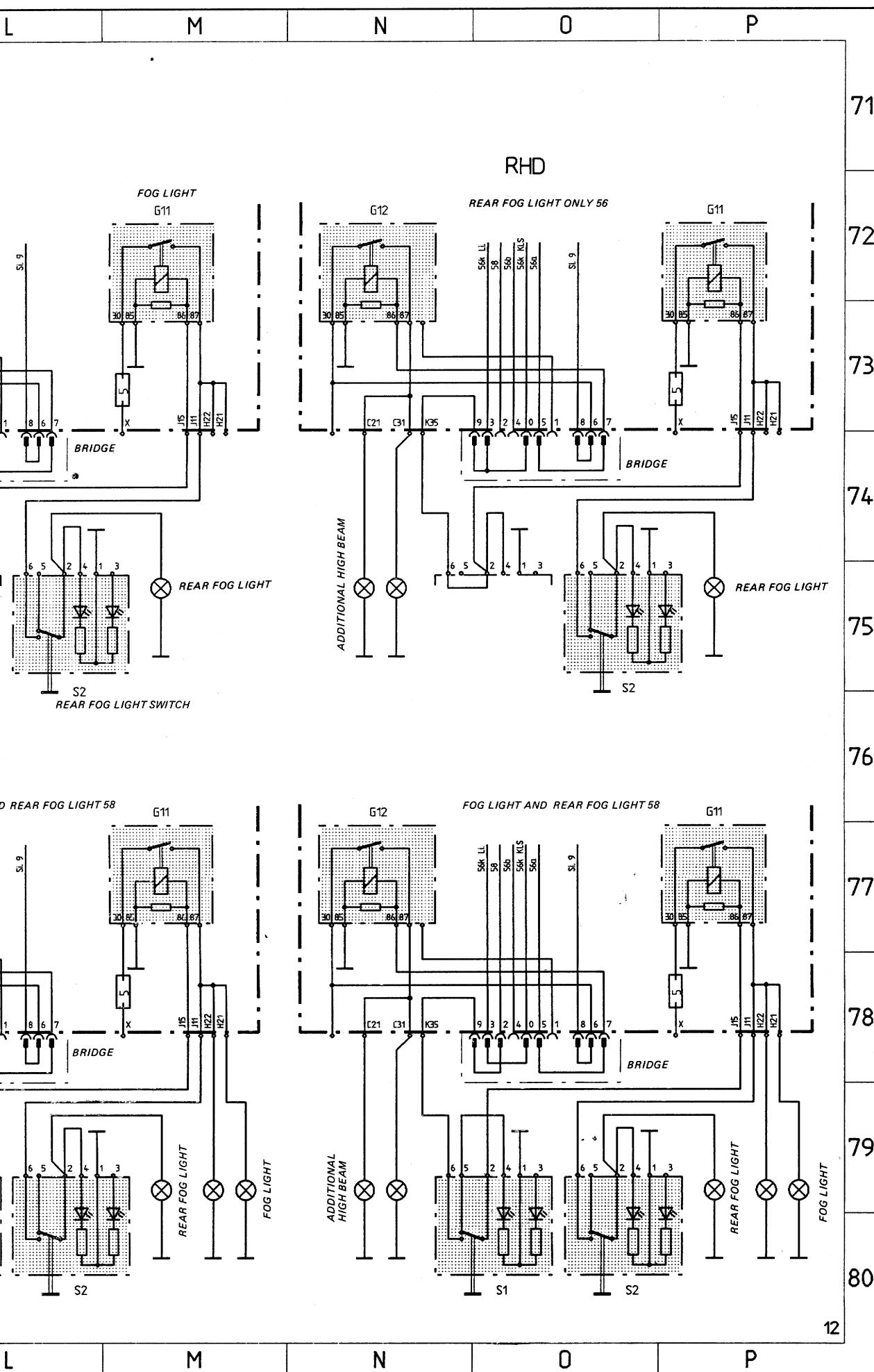

Wiring Diagram Type 944, 944 turbo 944 S Model 87 Sheet 13

RADIO

Wiring Diagram Type 944, 944 turbo, 944 S Model 87 S

RADIO

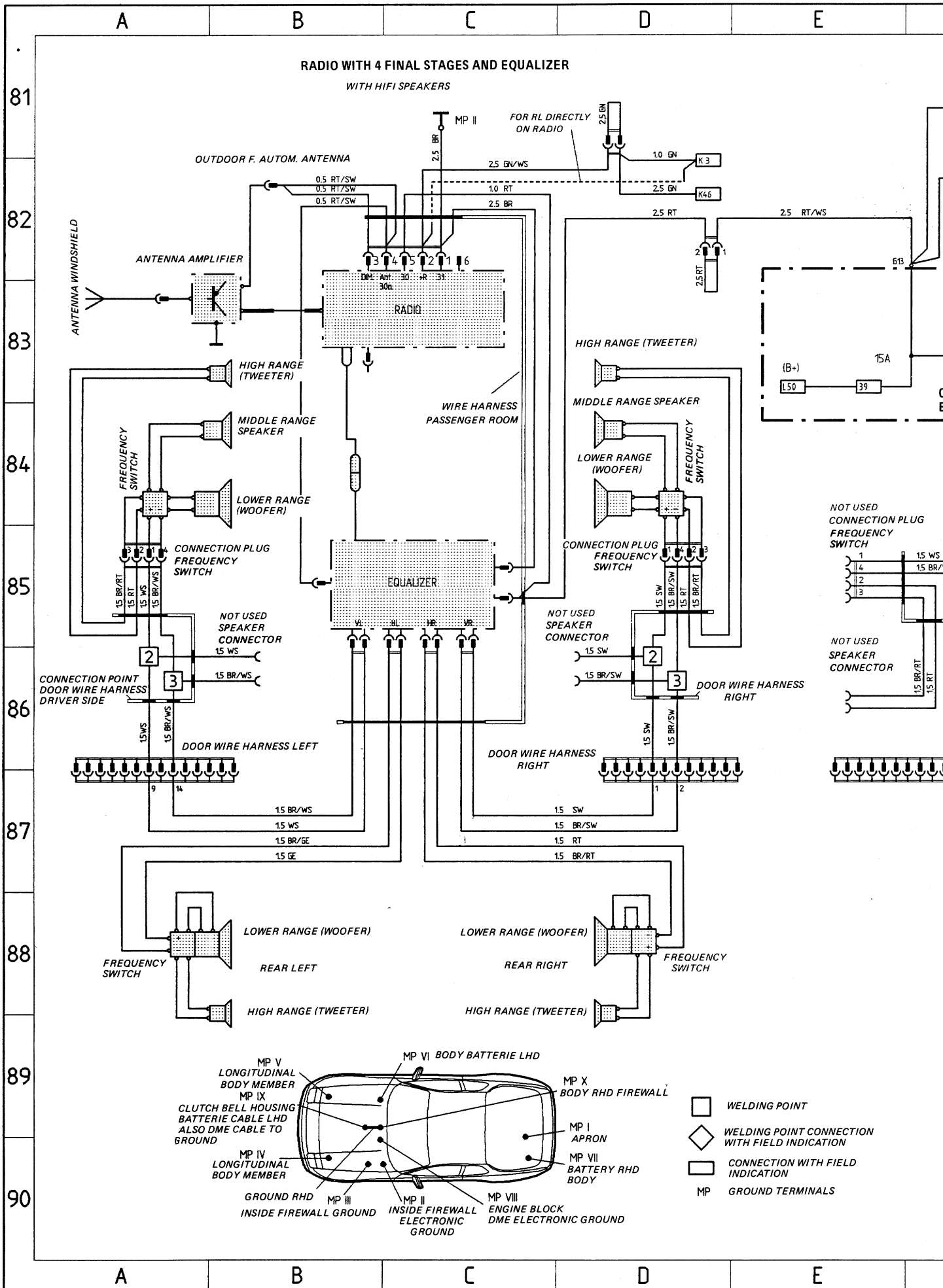

F G H J K L

RADIO WITH 2 FINAL STAGES
RADIO WITH 4 FINAL STAGES

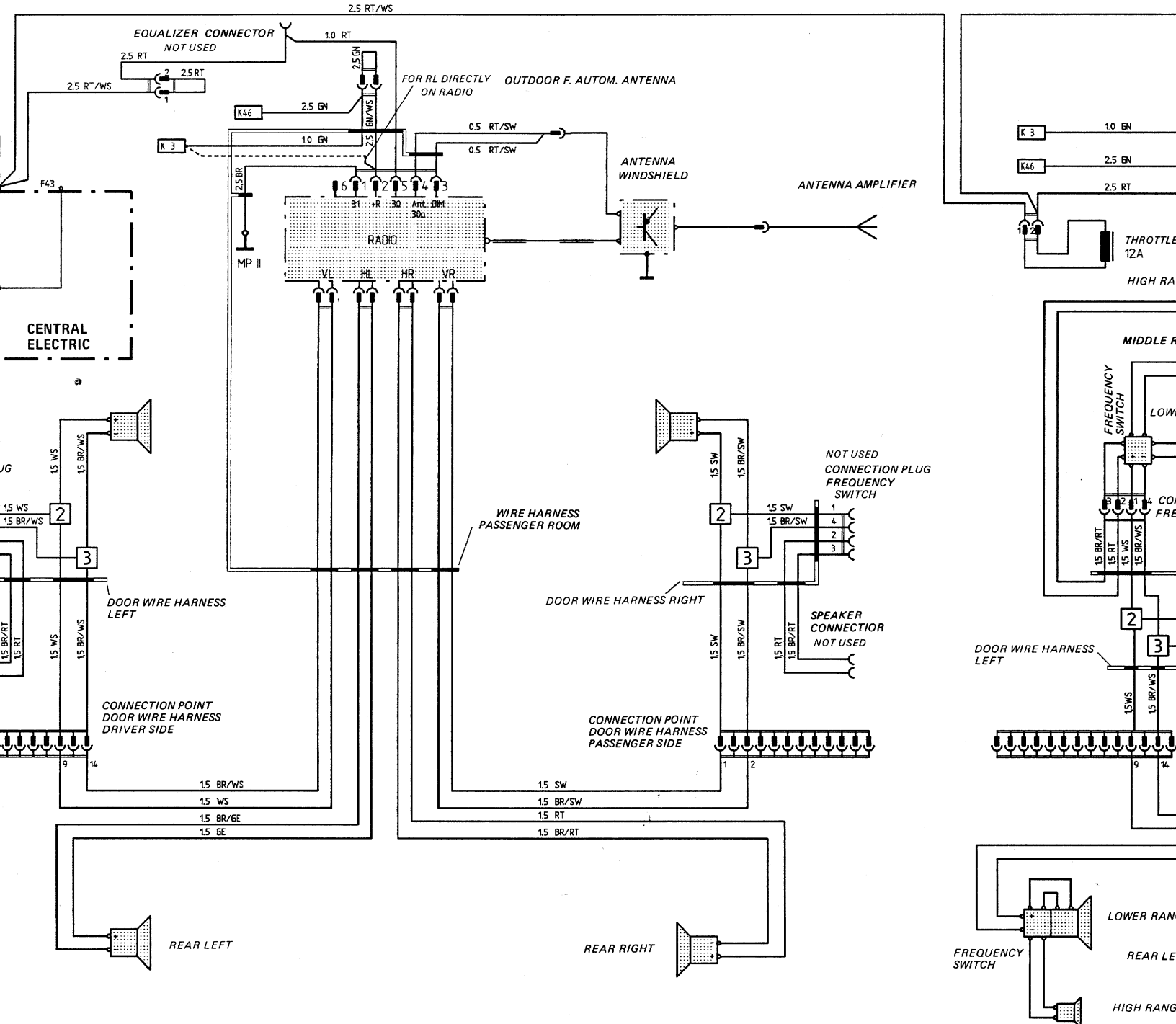

CONNECTORS RADIO

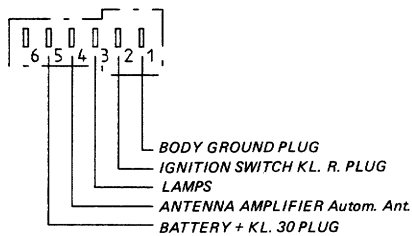

EQUALIZER CONNECTORS

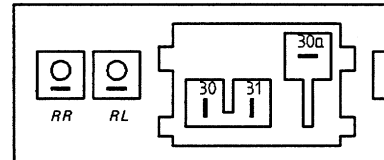

F G H J K L

L M N O P

RADIO BERLIN IQR 86

WITH HIFI SPEAKERS

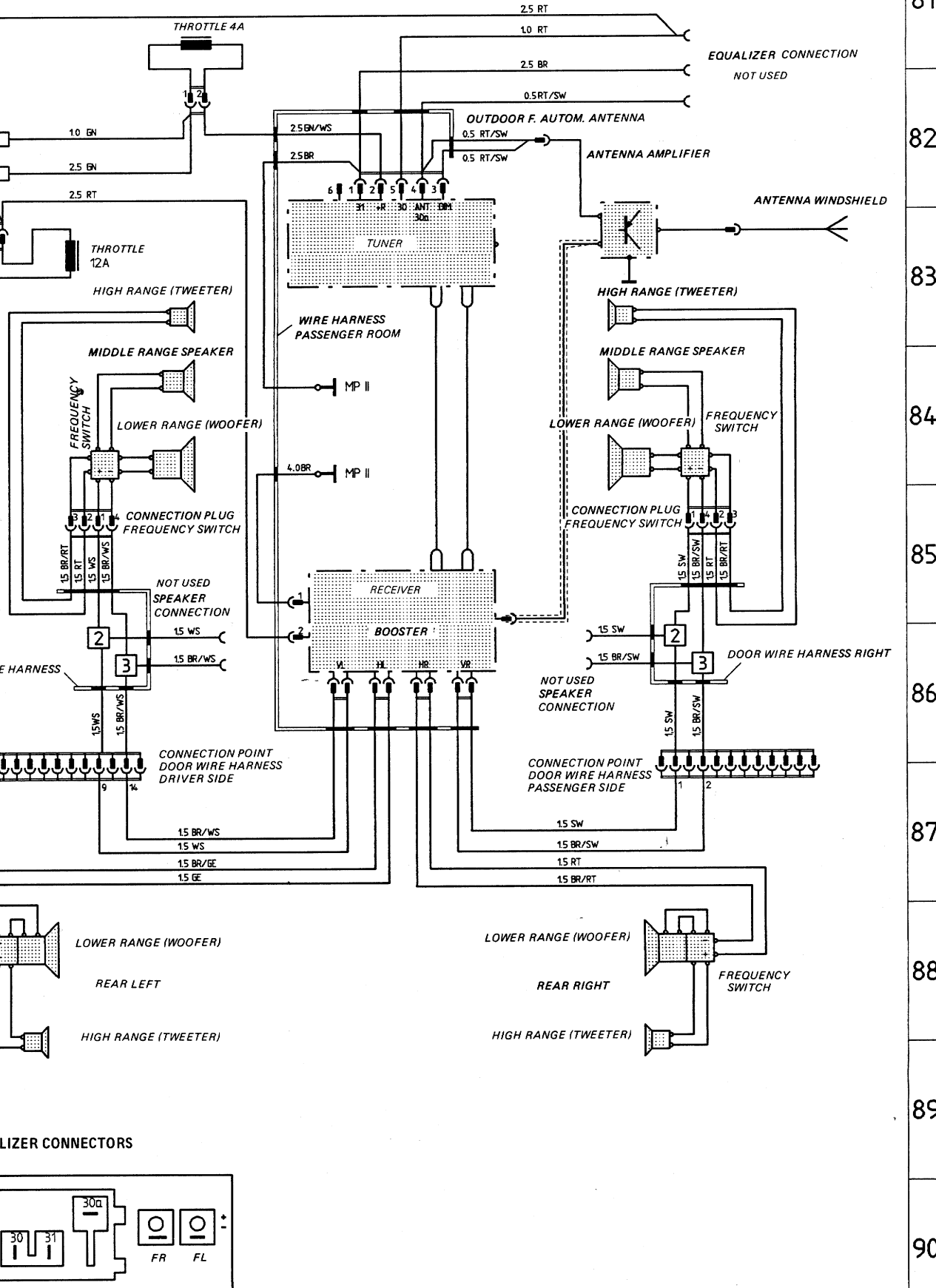

81
82
83
84
85
86
87
88
89
90
13

L M N O P

Wiring Diagram Type 944, 944 turbo 944 S Model 87 Sheet 14

ABS, AIRBAG

Wiring Diagram Type 944, 944 turbo, 944 S Model 87 She

ABS, AIRBAG

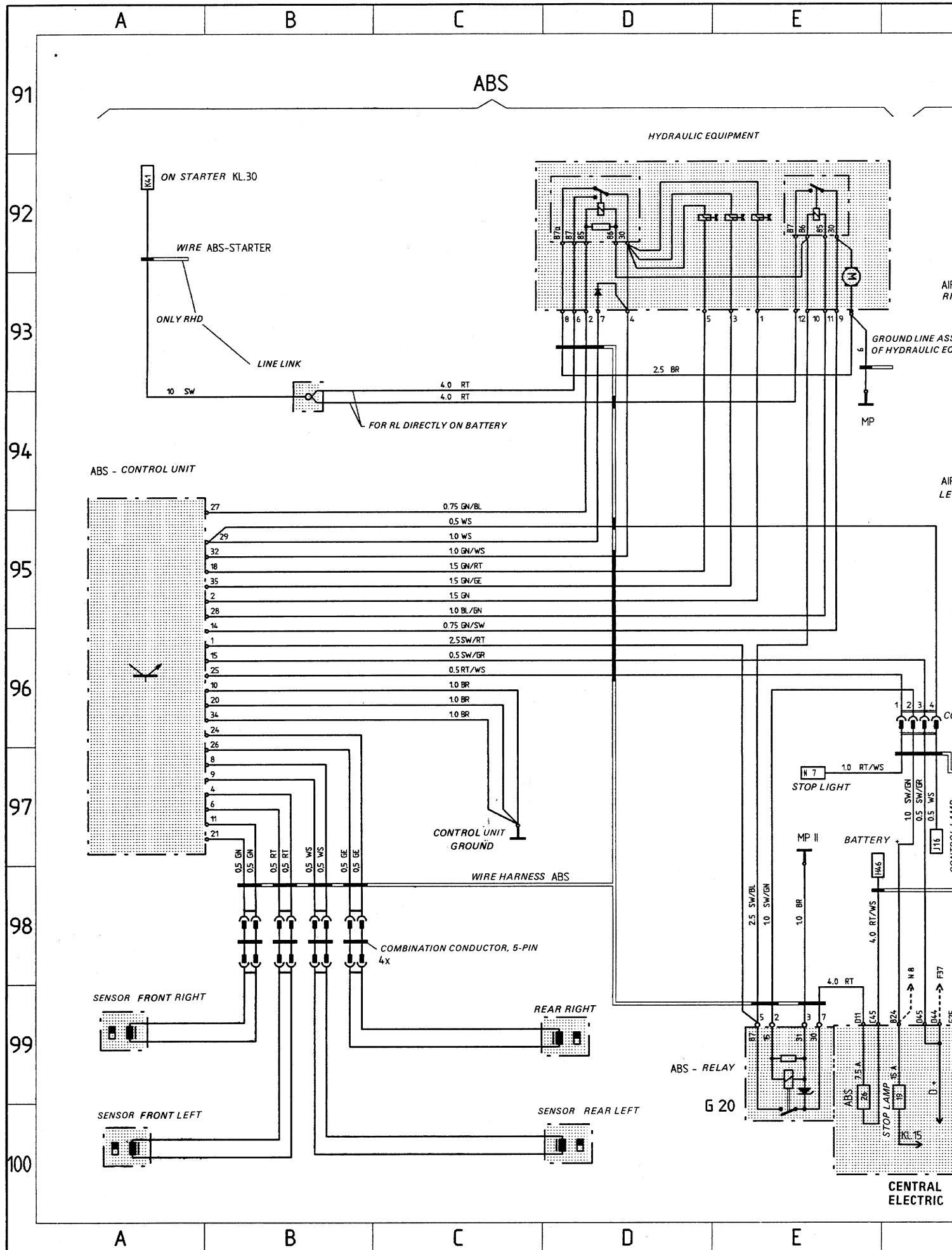

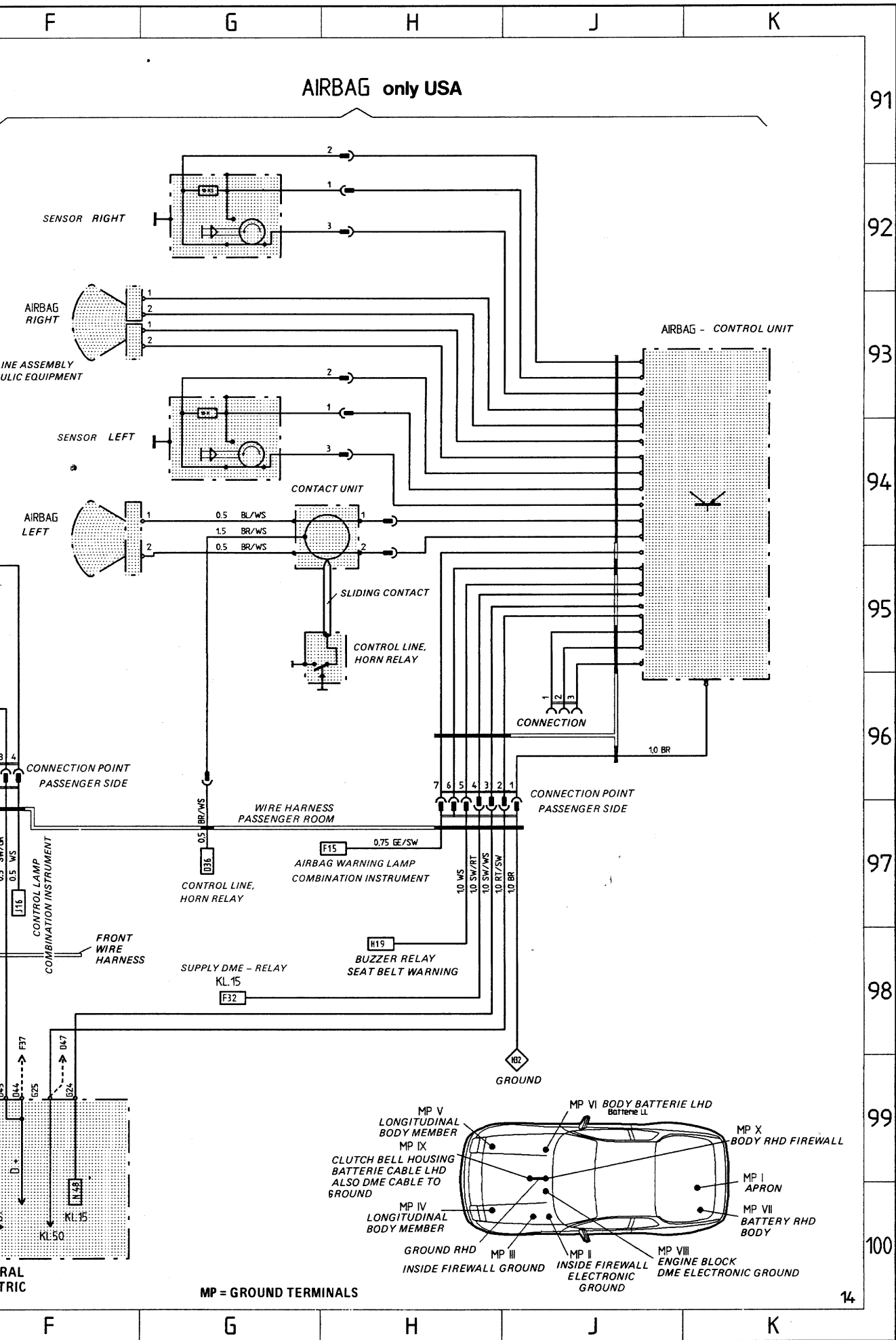

MP = GROUND TERMINALS

Wiring Diagram Type 924 S Model 86

SHEET 1	LIGHTING
SHEET 2	INSTRUMENT CLUSTER, SENSORS, TILTING ROOF
SHEET 3	HEATING, VENTILATION, WIPER AND WASHER SYSTEM
SHEET 4	AC, WINDOW LIFTERS, ALARM SYSTEM
SHEET 5	AC RHD
SHEET 6	ENGINE, TEMPOSTAT
SHEET 7	CENTRAL ELECTRICAL SYSTEM

Wiring Diagram Type 924 S Model 86

The wiring diagram consists of seven individual wiring diagrams. These are divided into coordinate fields.

Each individual wiring diagram contains a part of the central-electrics box in a dash-dotted frame.

This part of the central-electrics box shows all the lines and relays necessary for the individual wiring diagram.

The earth/ground points are identified by "MP" and their location is shown in a vehicle diagram.

Wiring Diagram Type 924 S Model 86 Sheet 1

LIGHTING

Wiring Diagram Type 924 S Model 86 Sheet 1

LIGHTING

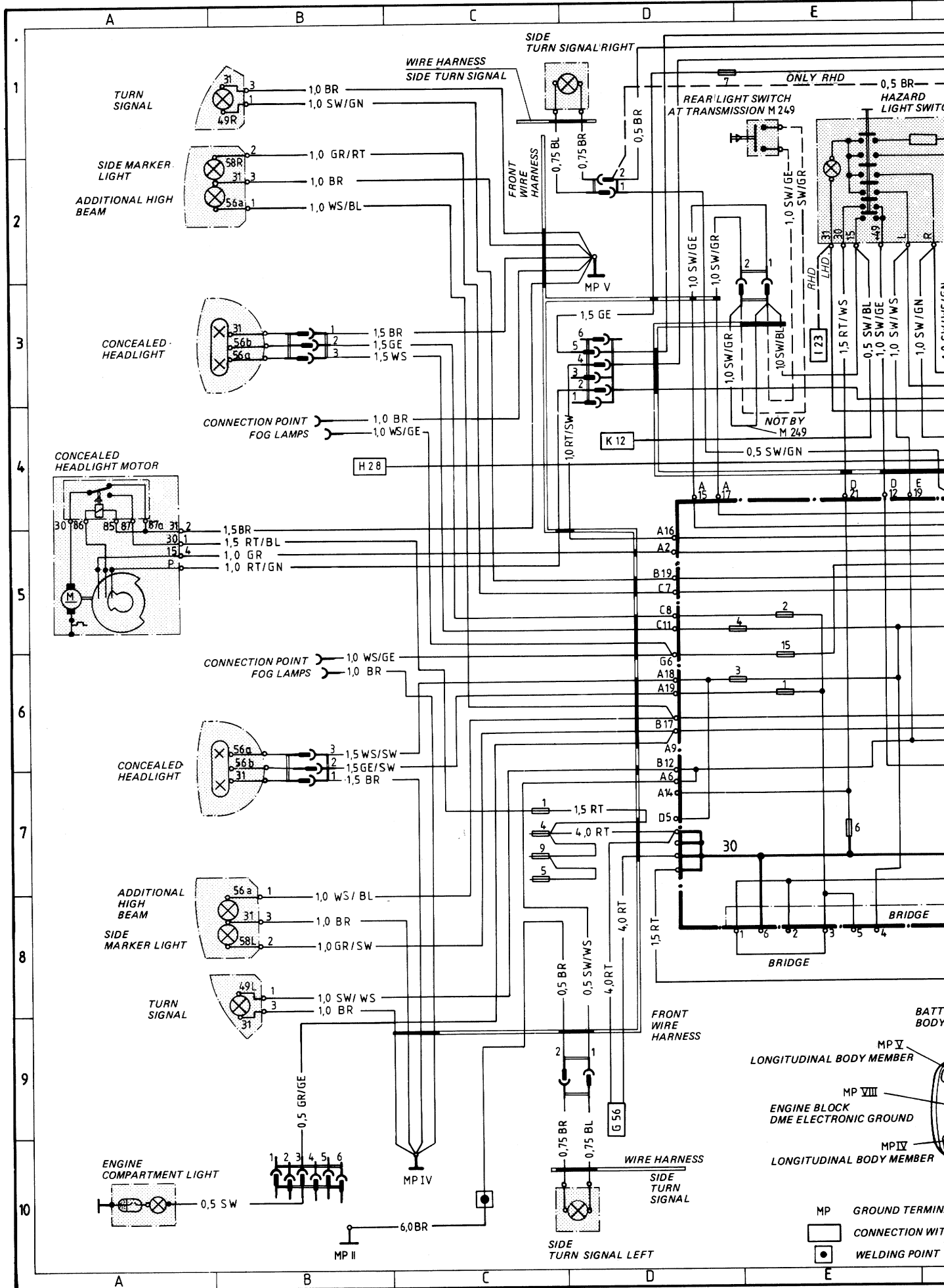

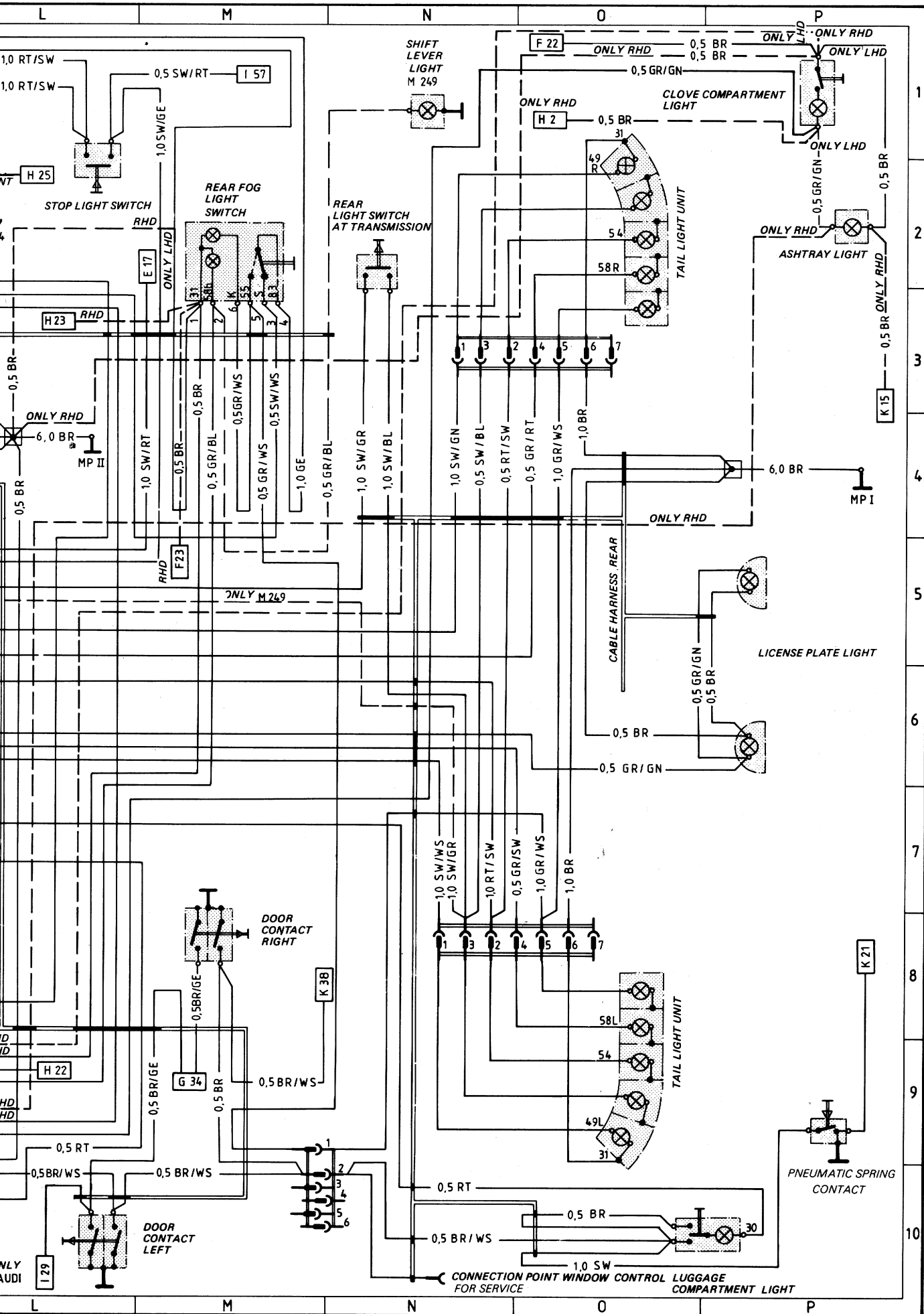

Wiring Diagram Type 924 S Model 86 Sheet 2

INSTRUMENT CLUSTER, SENSORS,
TILTING ROOF

Wiring Diagram Type 924 S Model 86 Sheet 2

INSTRUMENT CLUSTER, SENSORS, TILTING ROOF

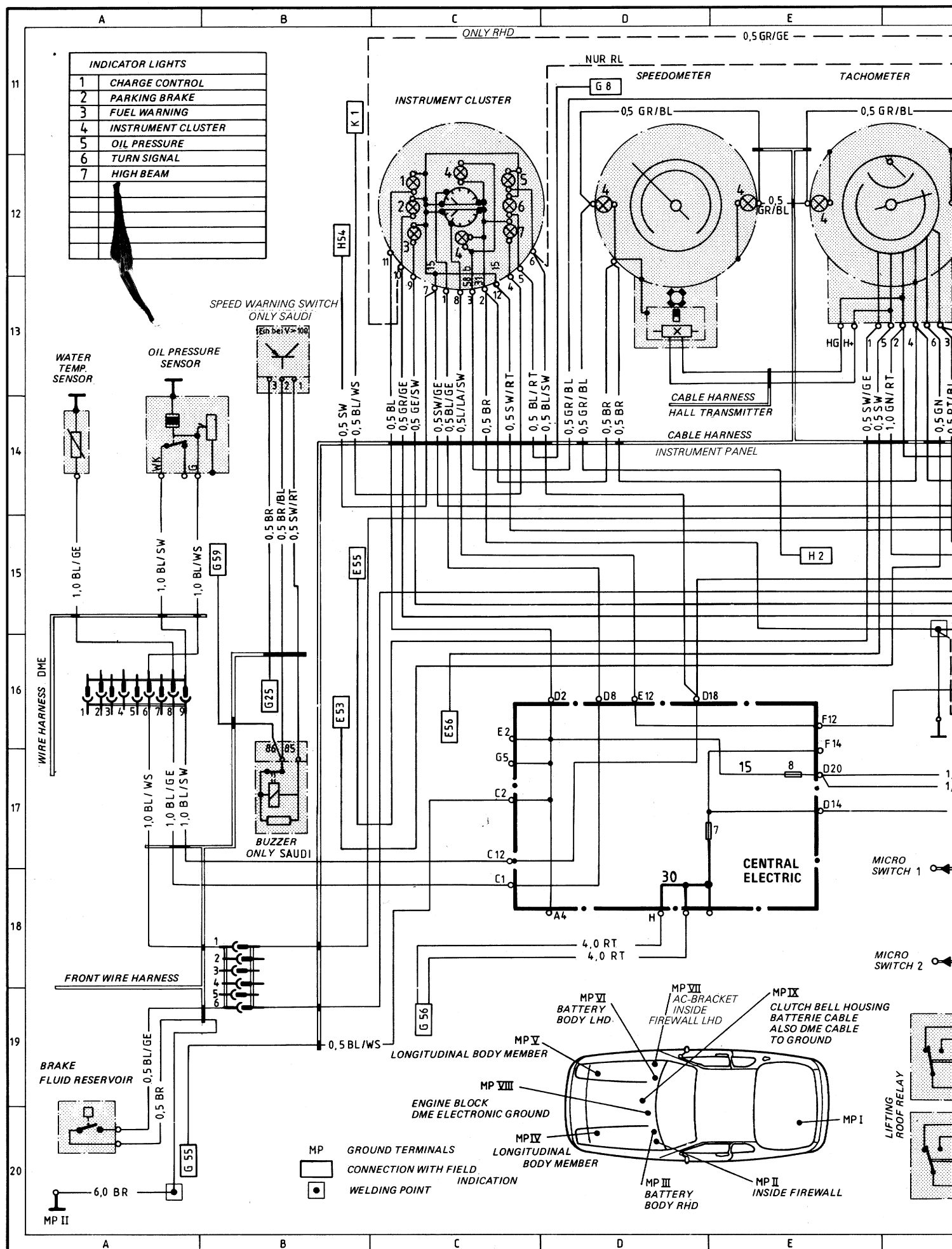

Wiring Diagram Type 924 S Model 86 Sheet 3

HEATING, VENTILATION,
WIPER AND WASHER SYSTEM

Wiring Diagram Type 924 S Model 86 Sheet 3

HEATING, VENTILATION, WIPER AND WASHER SYSTEM

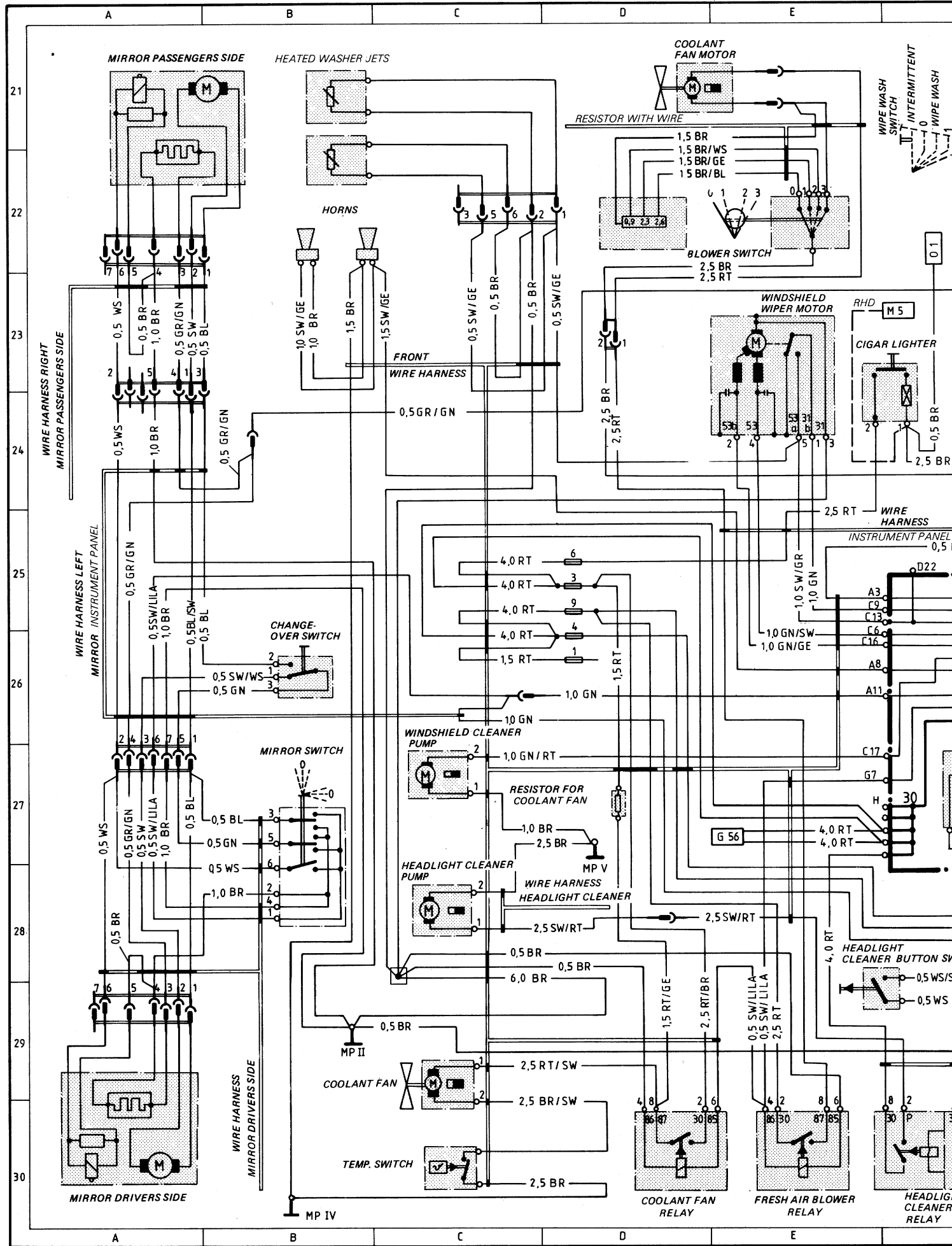

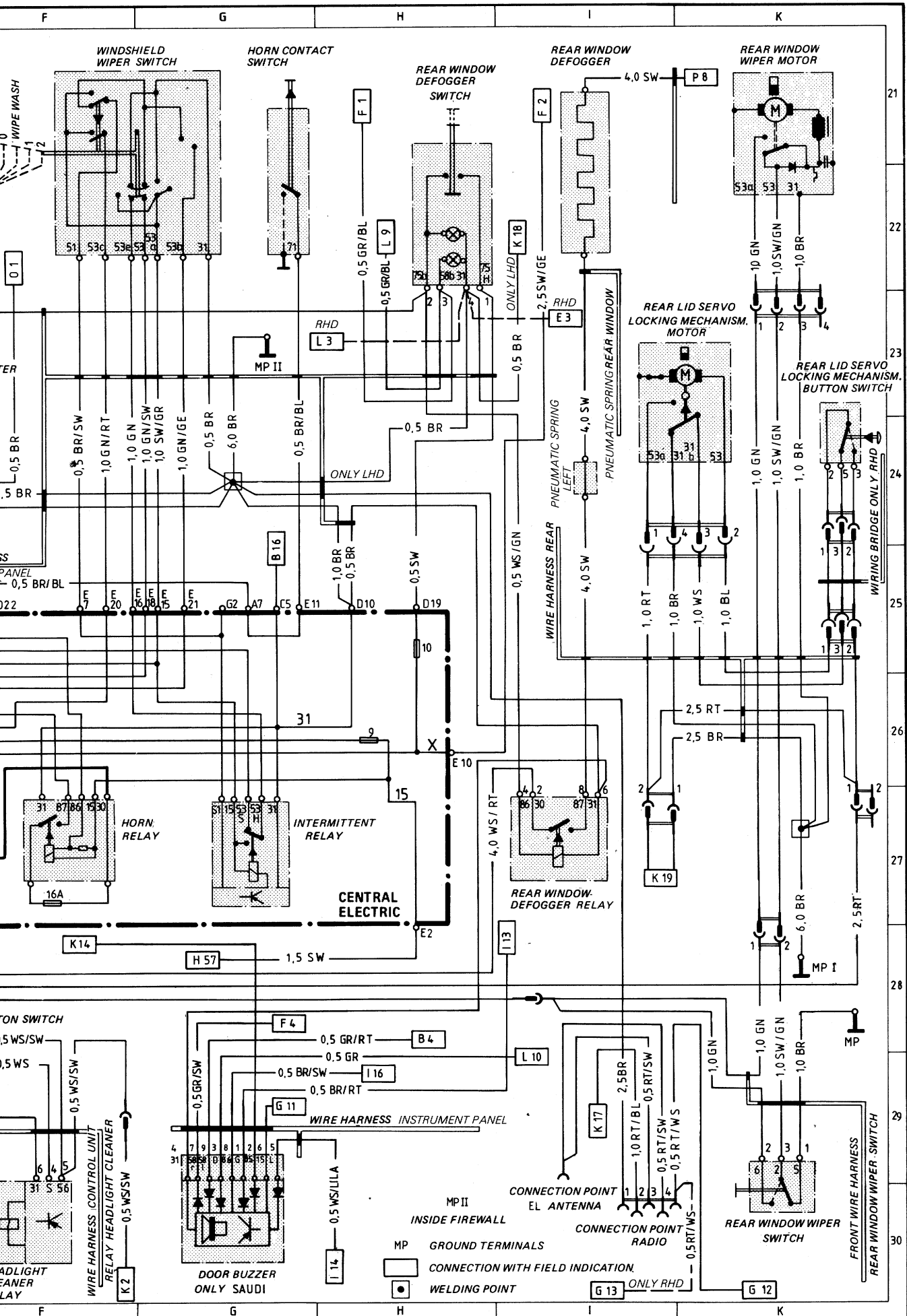

Wiring Diagram Type 924 S Model 86 Sheet 4

AC, WINDOW LIFTERS, ALARM SYSTEM



Wiring Diagram Type 924 S Model 86 Sheet 4

AC, WINDOW LIFTERS, ALARM SYSTEM

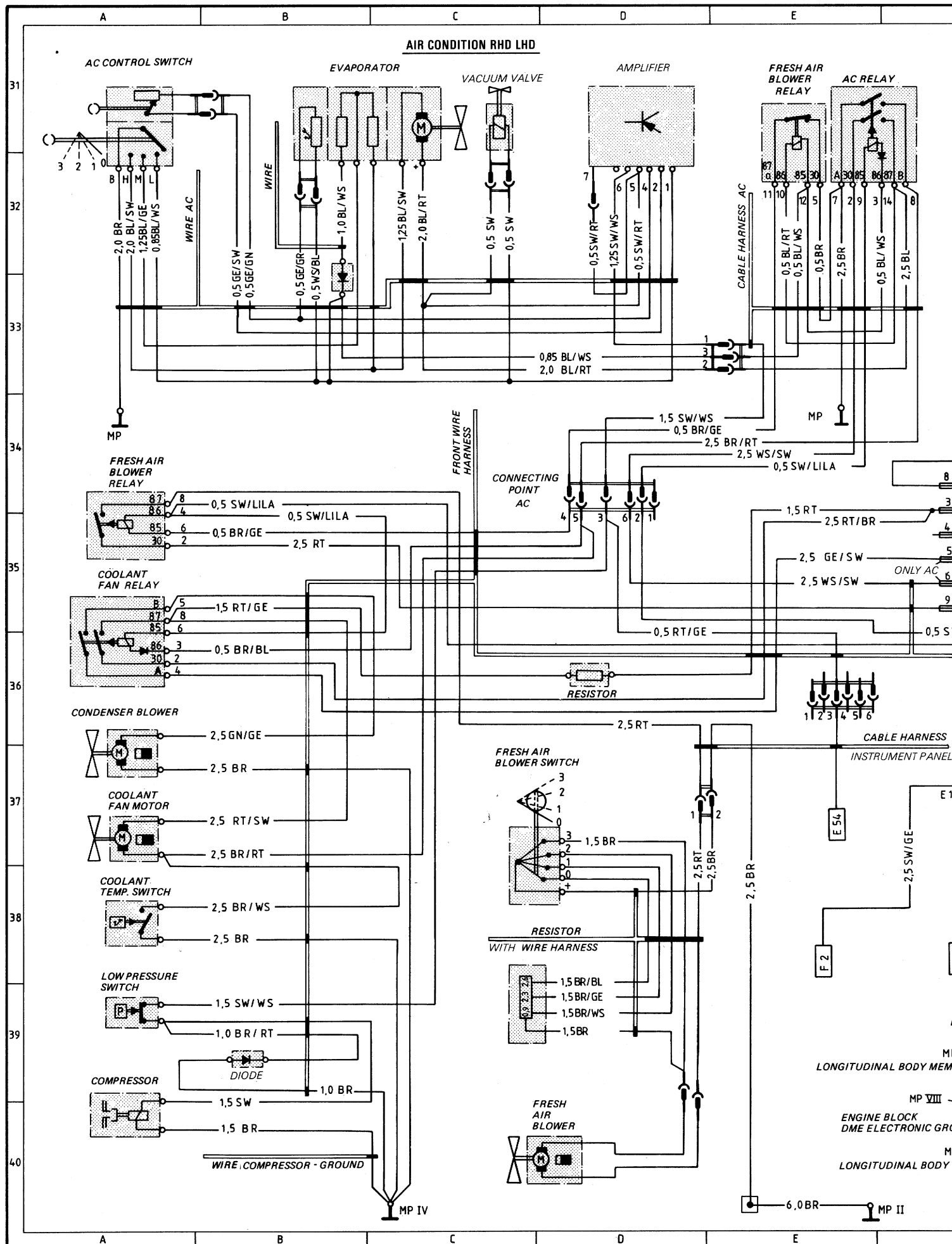

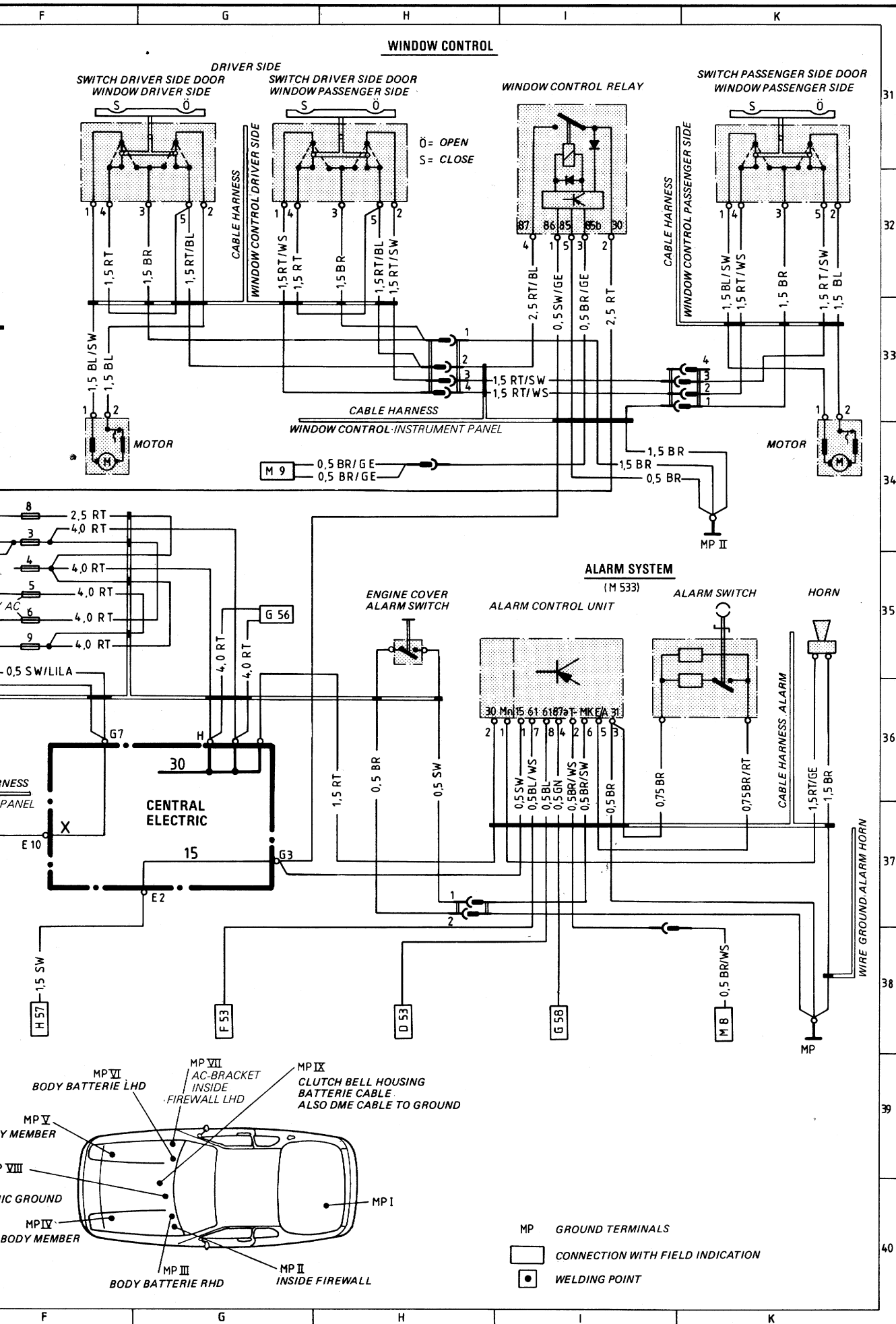

Wiring Diagram Type 924 S Model 86 Sheet 5

AC RHD

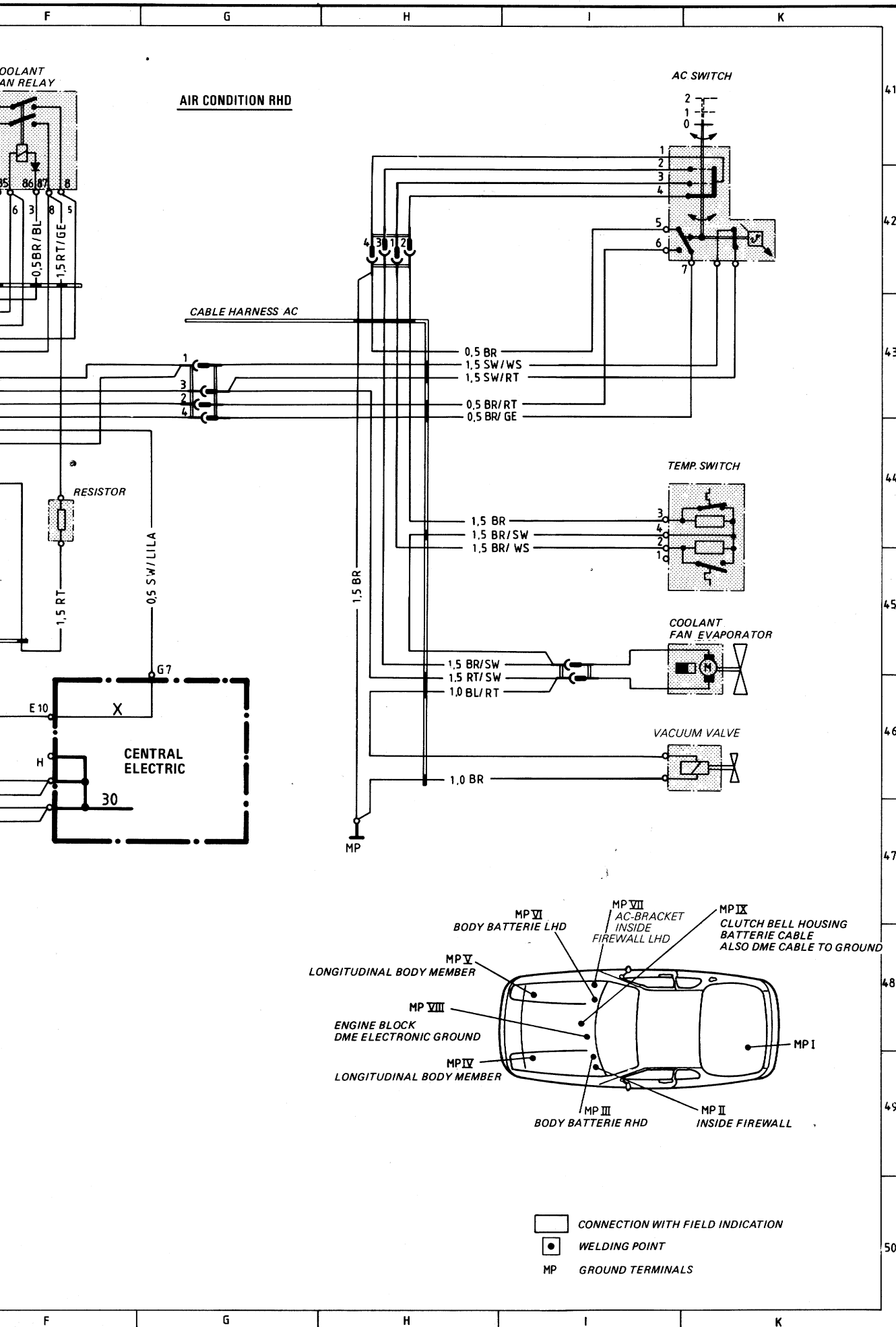

Wiring Diagram Type 924 S Model 86 Sheet 6

ENGINE, TEMPOSTAT

Wiring Diagram Type 924 S Model 86 Sheet 6

ENGINE, TEMPOSTAT

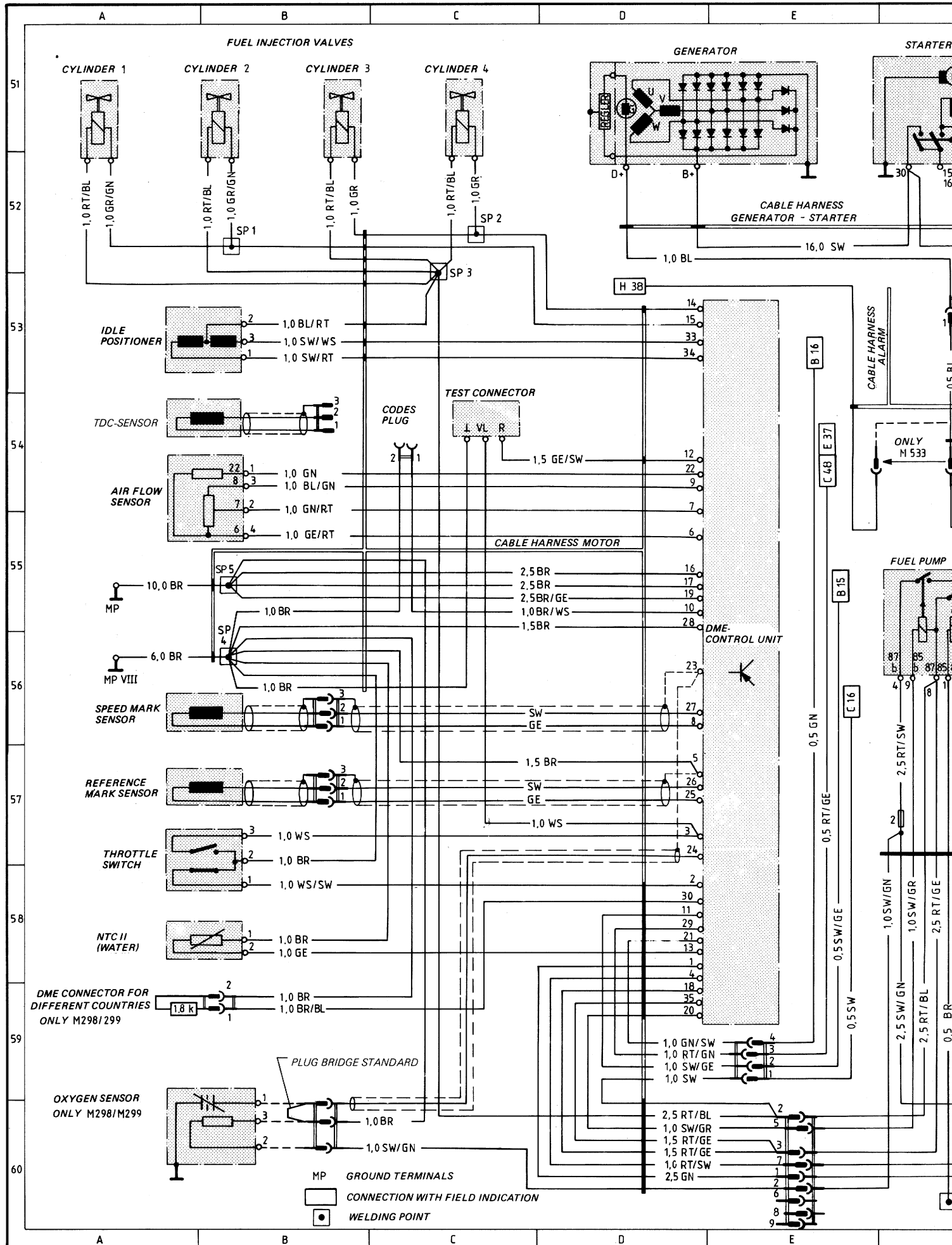

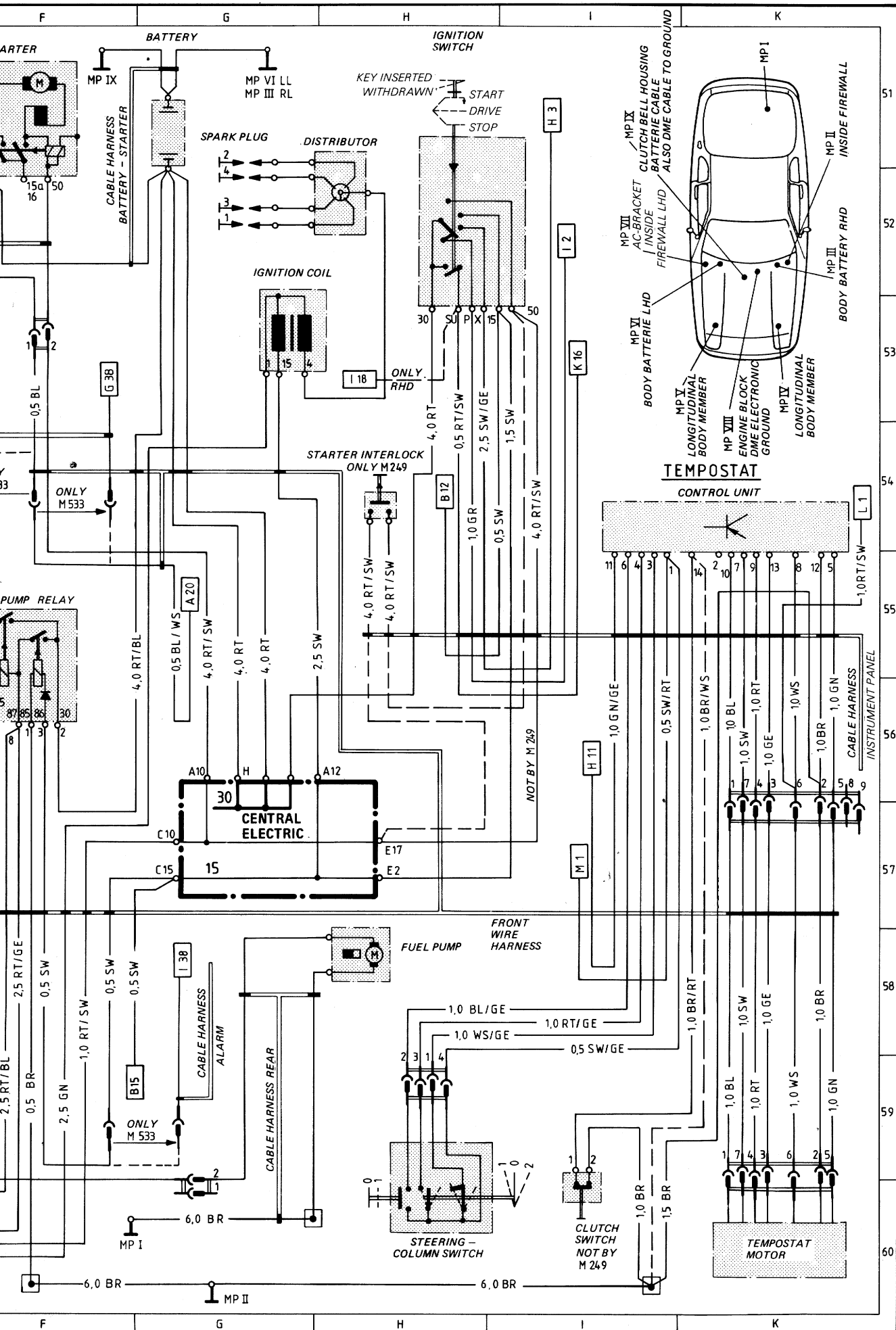

Wiring Diagram Type 924 S Model 86 Sheet 7

CENTRAL ELECTRICAL SYSTEM

Wiring Diagram Type 924 S Model 86 Sheet 7

CENTRAL ELECTRICAL SYSTEM

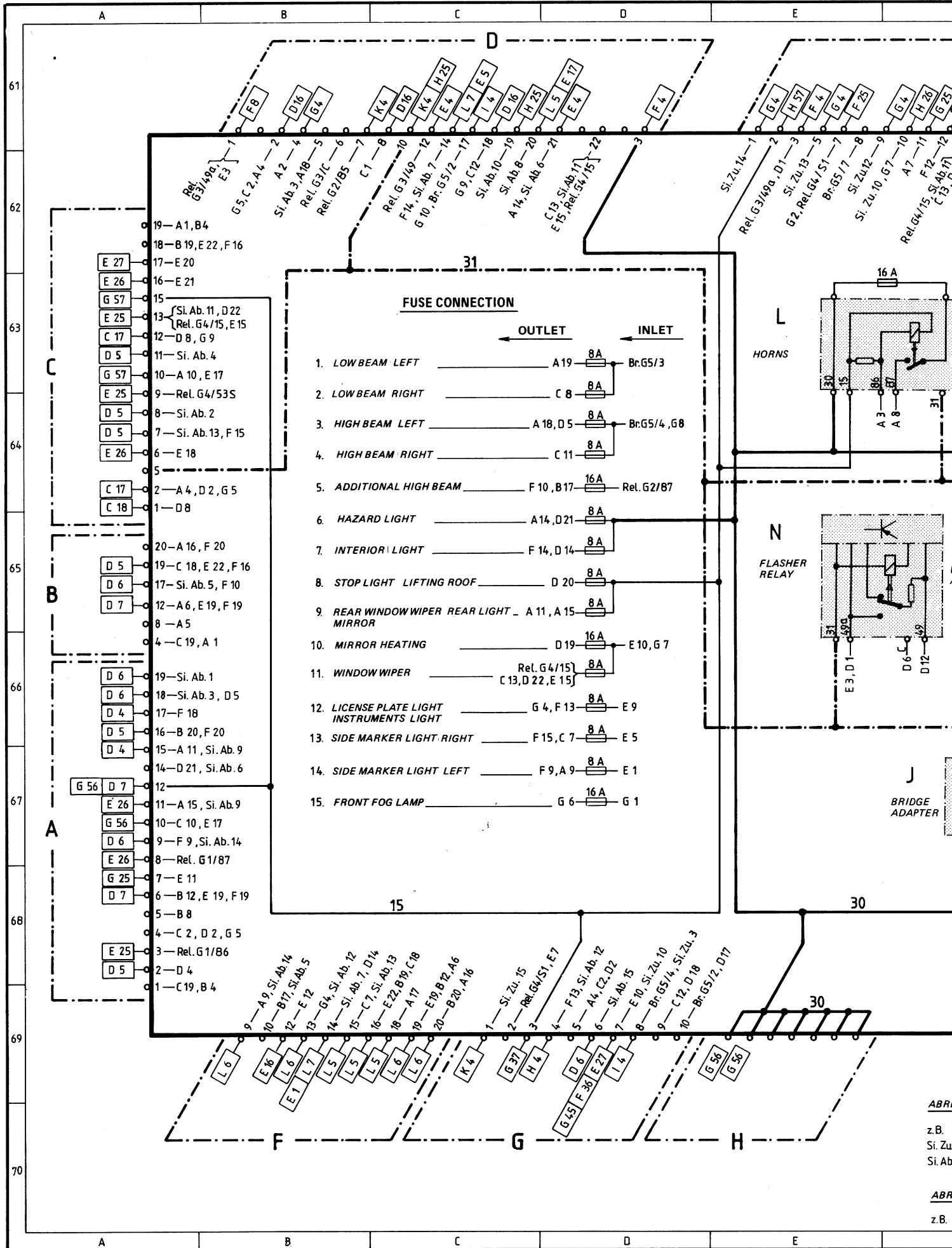

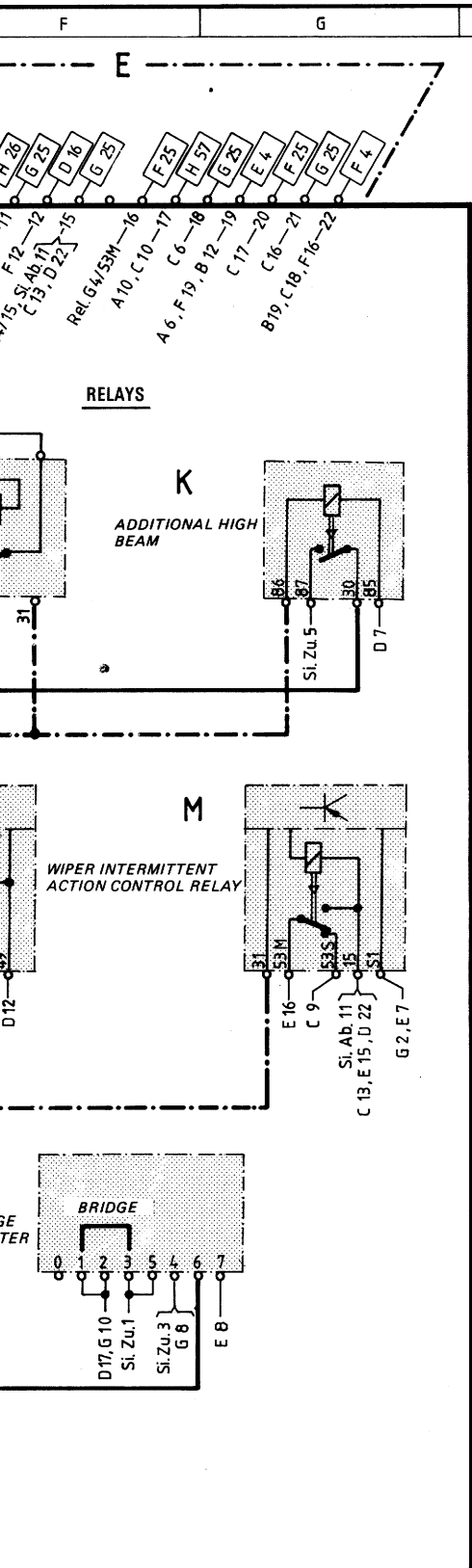

9-WAY FUSE PANEL

- | | | |
|--|------|-----------|
| 1. CONCEALED HEADLIGHT MOTOR | 16 A | C 7 |
| 2. FUEL PUMP | 16 A | F 57 |
| 3. COOLANT FAN | 25 A | F 35 E 45 |
| 4. REAR WINDOW DEFOGGER | 25 A | D 25 |
| 5. COOLANT FAN - CONDENS. | 25 A | F 35 E 45 |
| 6. AIR CONDITION | 25 A | F 35 E 45 |
| 7. REAR FOG LIGHT | 8 A | D,E 1 |
| 8. CONTROL WINDOW | 16 A | F 34 |
| 9. FRESH AIR BLOWER, REAR LID SERVO LOCKING MECHANISM. | 25 A | D 25 |

ADDITIONAL RELAY

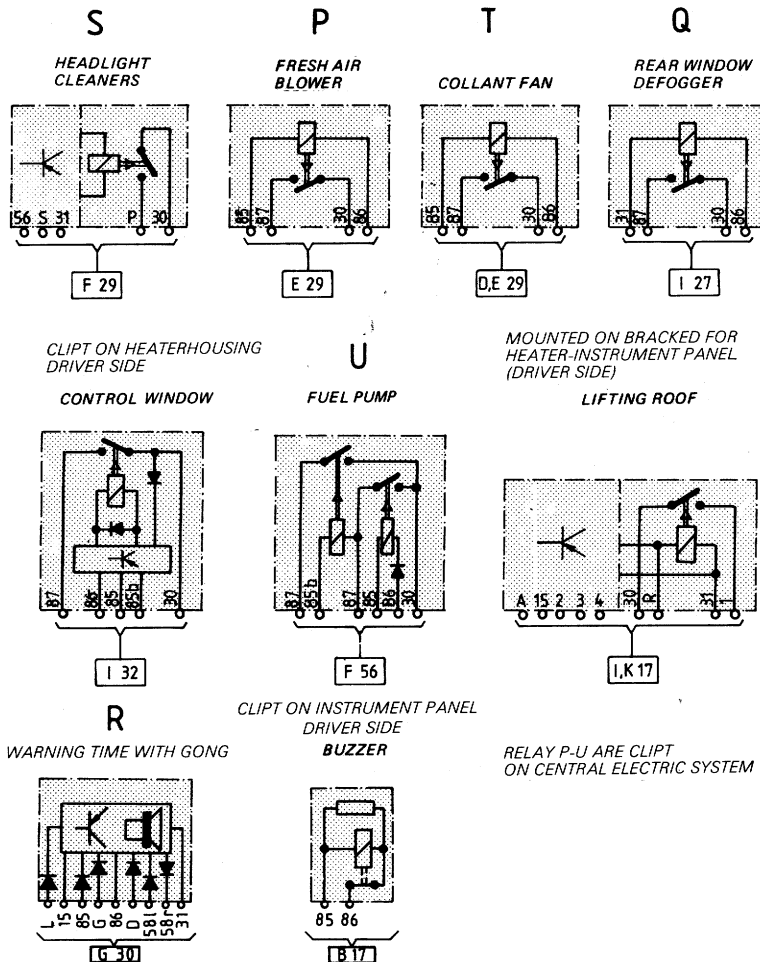

ABBREVIATIONS INSIDE

z.B. D 6 = PLUG CONNECTION
 Si. Zu. = FUSE INLET
 Si. Ab. = FUSE OUTLET

ABBREVIATIONS OUTSIDE

z.B. D 5 = CONNECTION WITH FIELD INDICATION

61
62
63
64
65
66
67
68
69
70

Wiring Diagram Type 924 S Model 87

SHEET 1	LIGHTING USA
SHEET 2	LIGHTING ROW
SHEET 3	INSTRUMENT CLUSTER, SENSORS, TILTING ROOF
SHEET 4	HEATING, VENTILATION, WIPER AND WASHER SYSTEM AND MIRRORS
SHEET 5	AC, WINDOW LIFTERS, ALARM SYSTEM
SHEET 6	AC RHD
SHEET 7	ENGINE, TEMPOSTAT
SHEET 8	CENTRAL ELECTRICAL SYSTEM
SHEET 9	RADIO

Wiring Diagram Type 924 S Model 87

The wiring diagram consists of **nine** individual wiring diagrams. These are divided into coordinate fields.

Each individual wiring diagram contains a part of the central-electrics box in a dash-dotted frame.

This part of the central-electrics box shows all the lines and relays necessary for the individual wiring diagram.

The earth/ground points are identified by "MP" and their location is shown in a vehicle diagram.

Wiring Diagram Type 924 S Model 87 Sheet 1

LIGHTING USA

Wiring Diagram Type 924 S Model 87 Sheet 1

LIGHTING USA

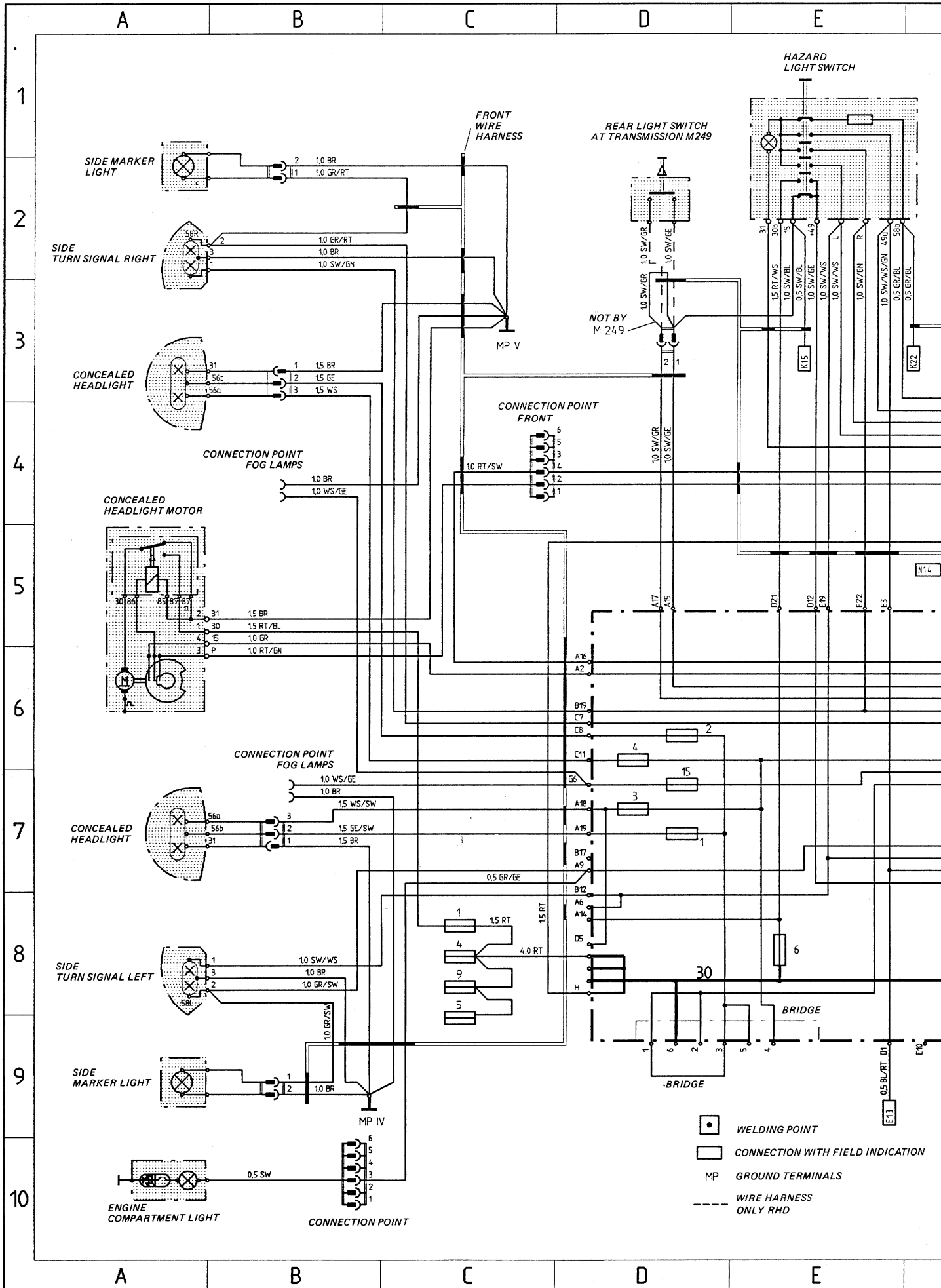

Wiring Diagram Type 924 S Model 87 Sheet 2

LIGHTING ROW

Wiring Diagram Type 924 S Model 87 Sheet 2

LIGHTING ROW

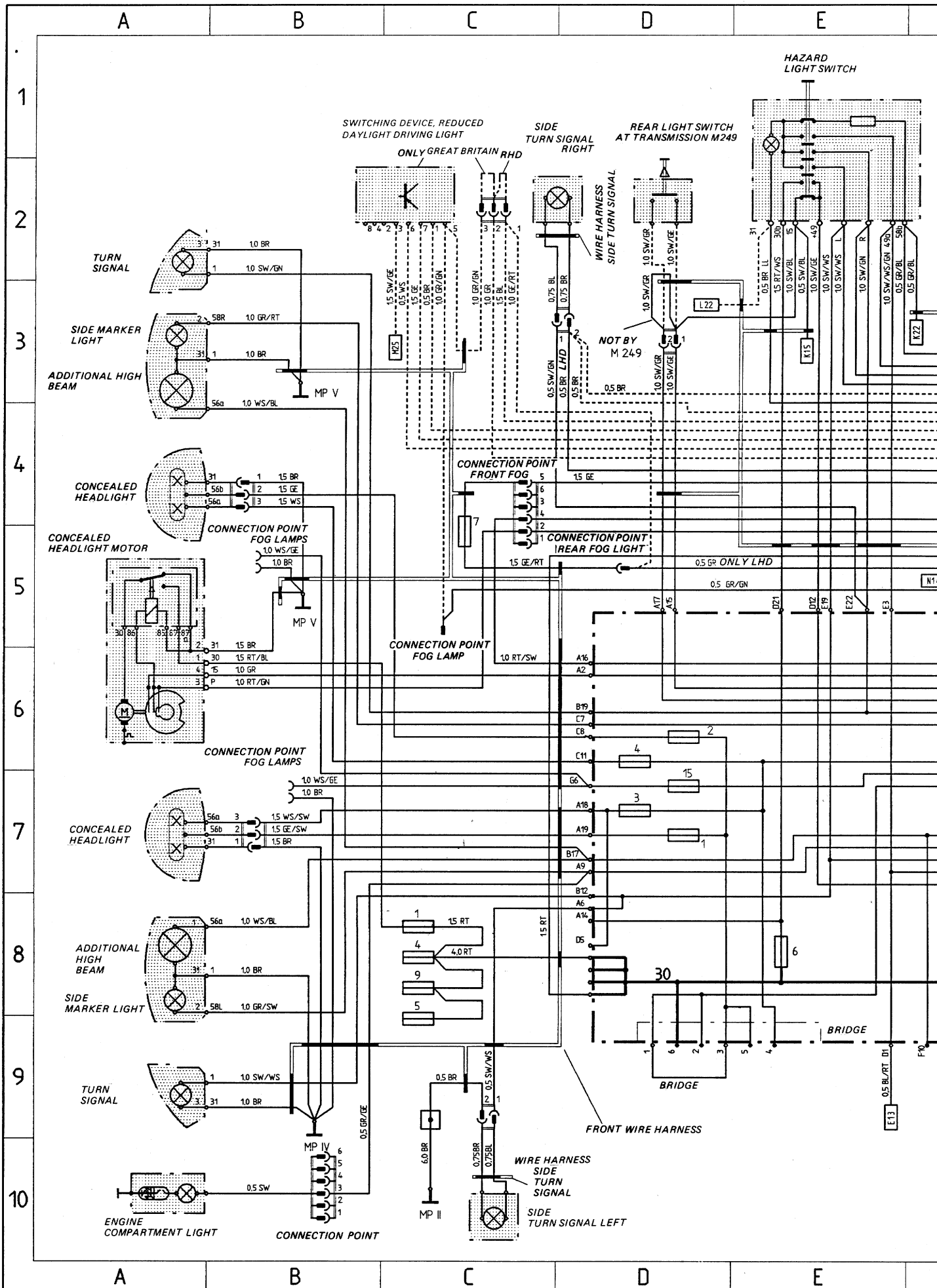

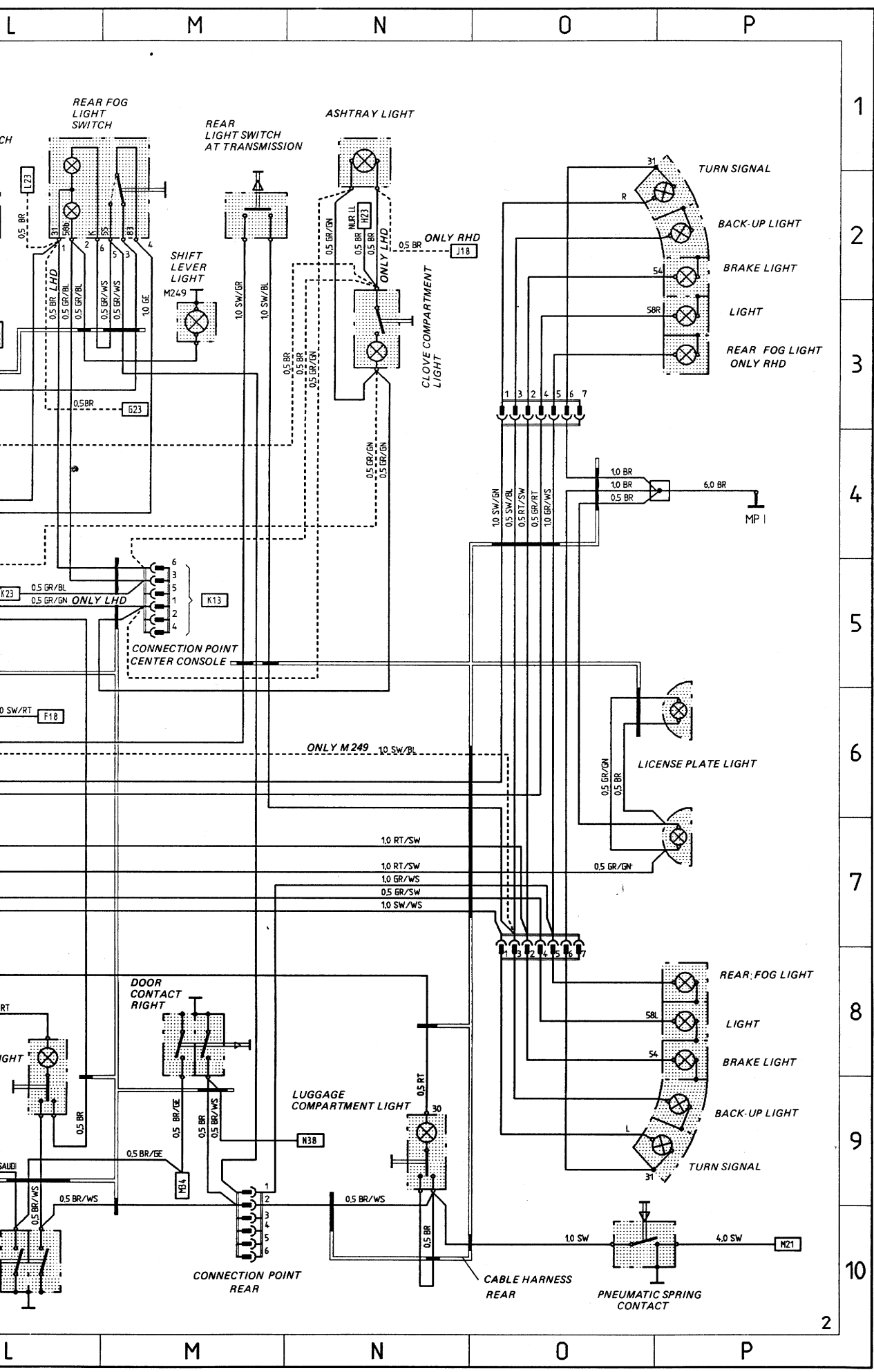

Wiring Diagram Type 924 S Model 87 Sheet 3

INSTRUMENT CLUSTER AND SENSORS
TILTING ROOF

Wiring Diagram Type 924 S Model 87 Sheet 3

INSTRUMENT CLUSTER, SENSORS, TILTING ROOF

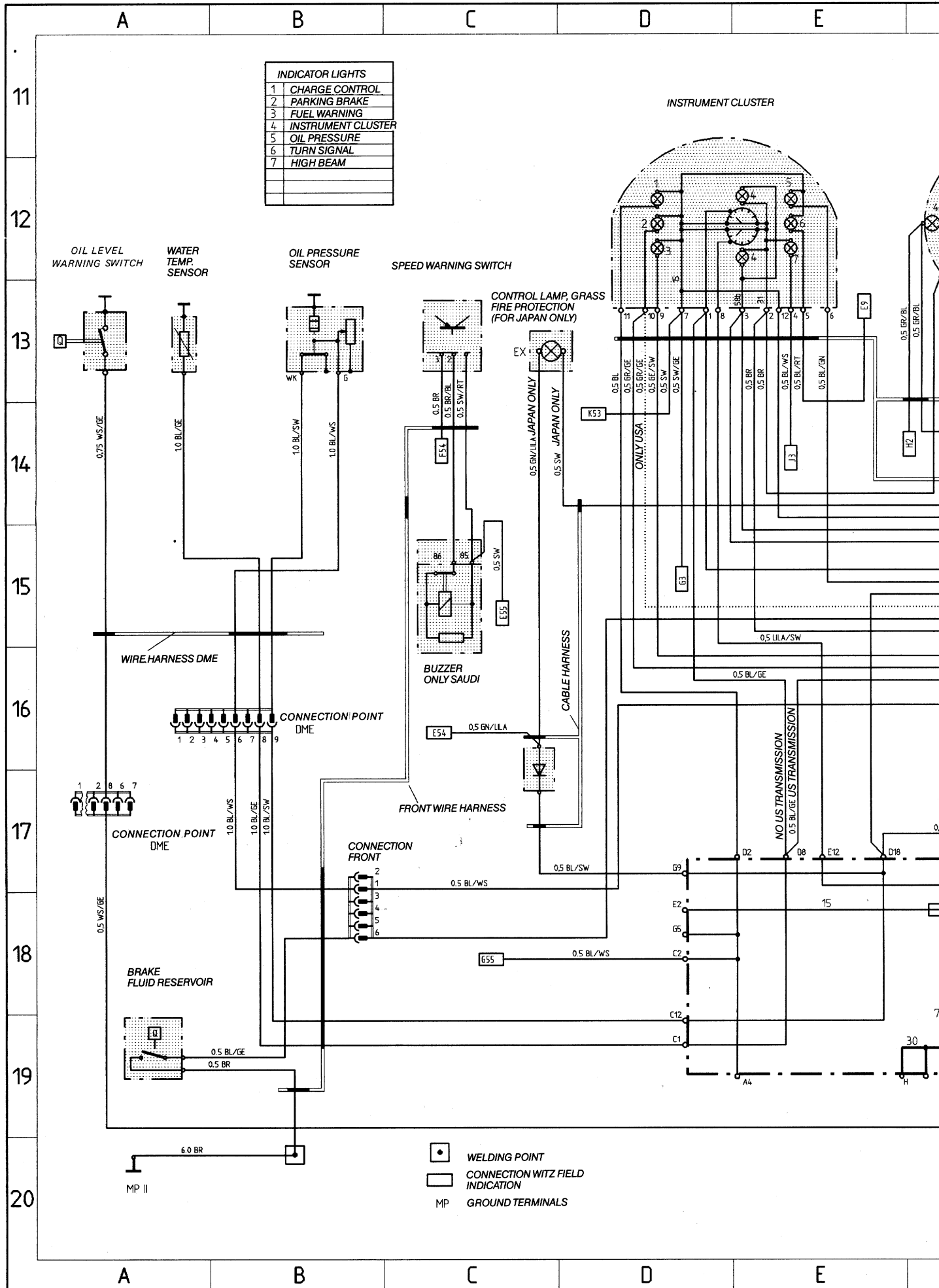

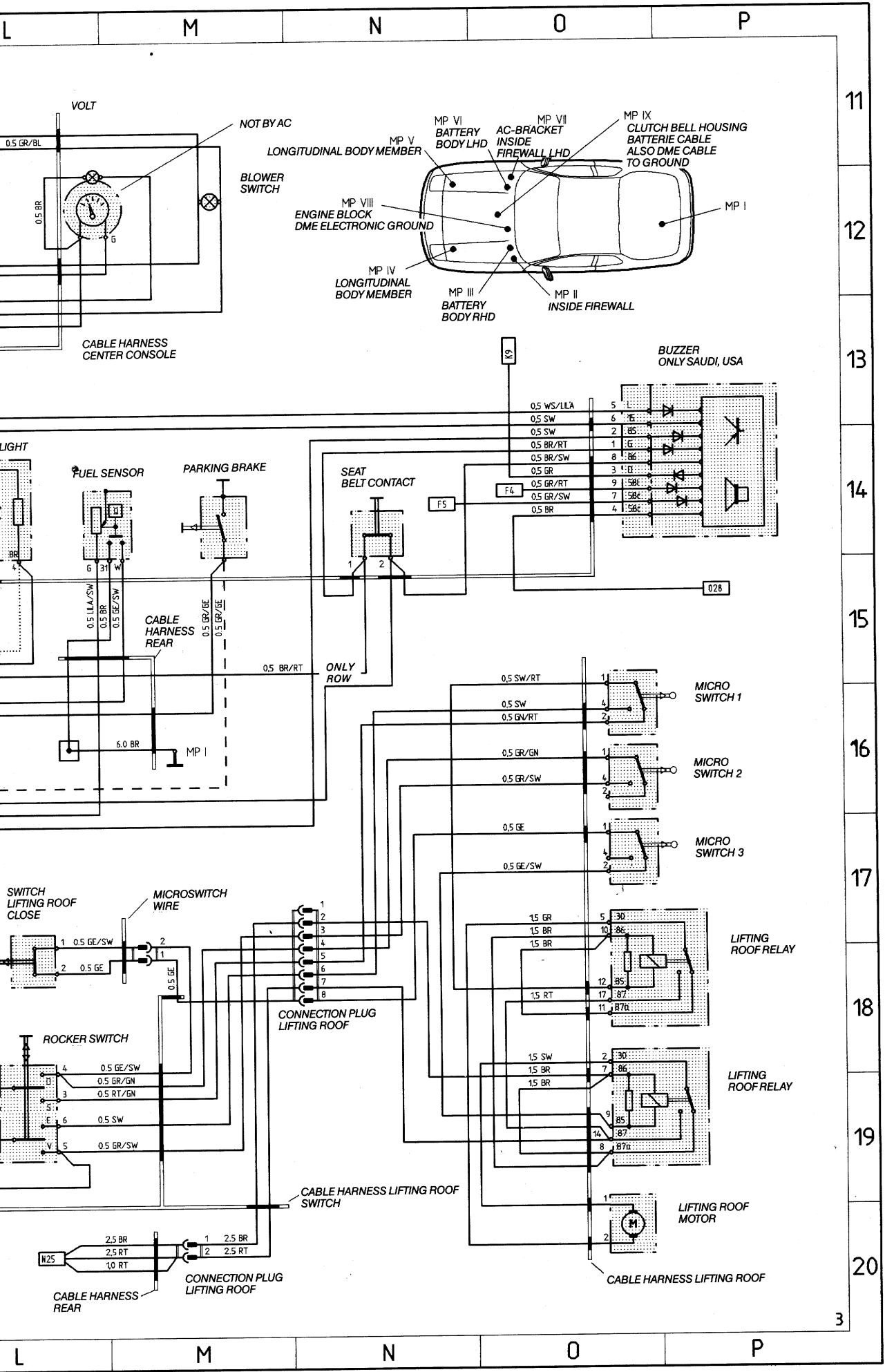

Wiring Diagram Type 924 S Model 87 Sheet 4

HEATING, VENTILATION, WIPER AND WASHER SYSTEM
AND MIRRORS

F G H J K L

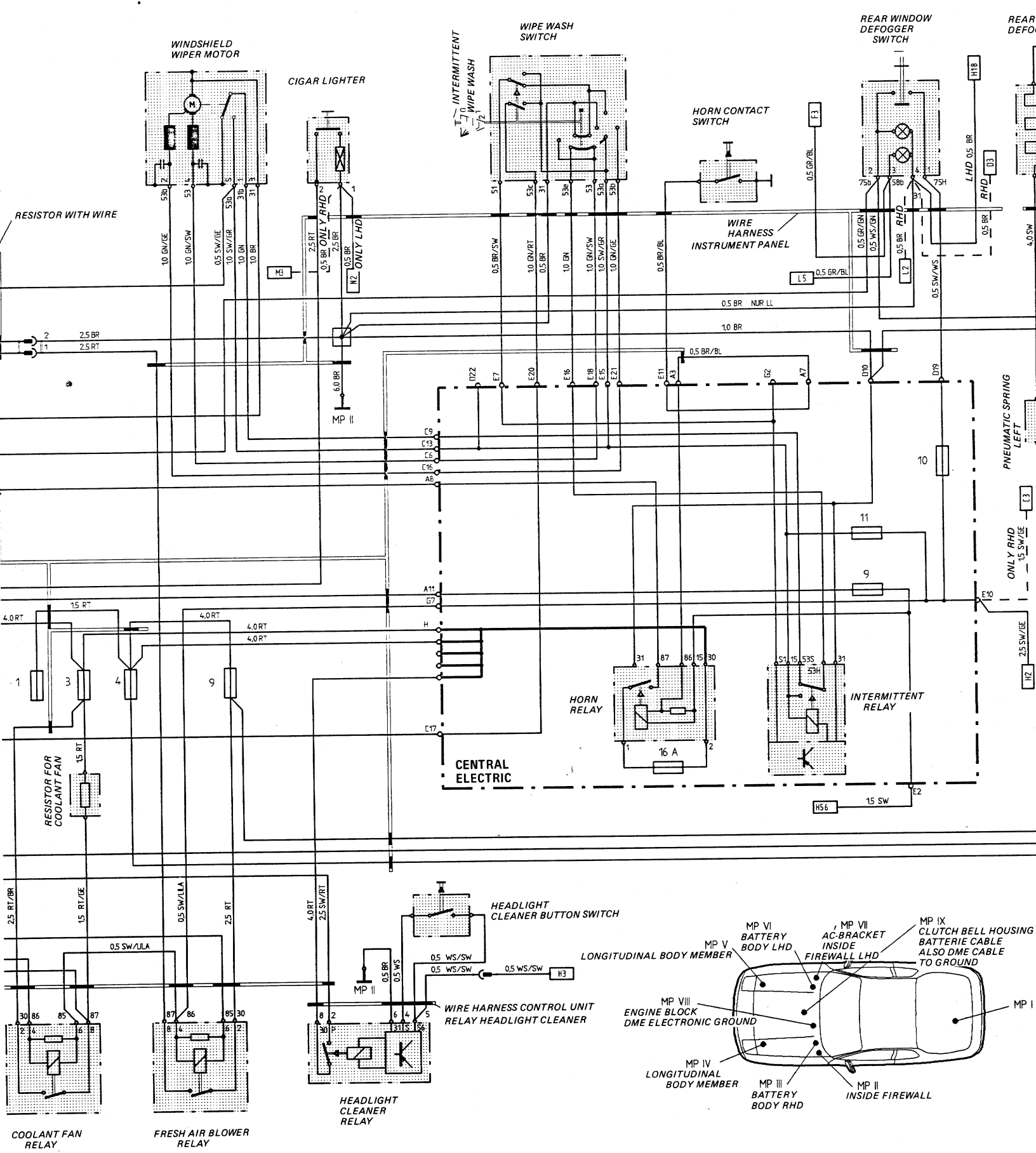

MP = GROUND TERMINALS

F G H J K L

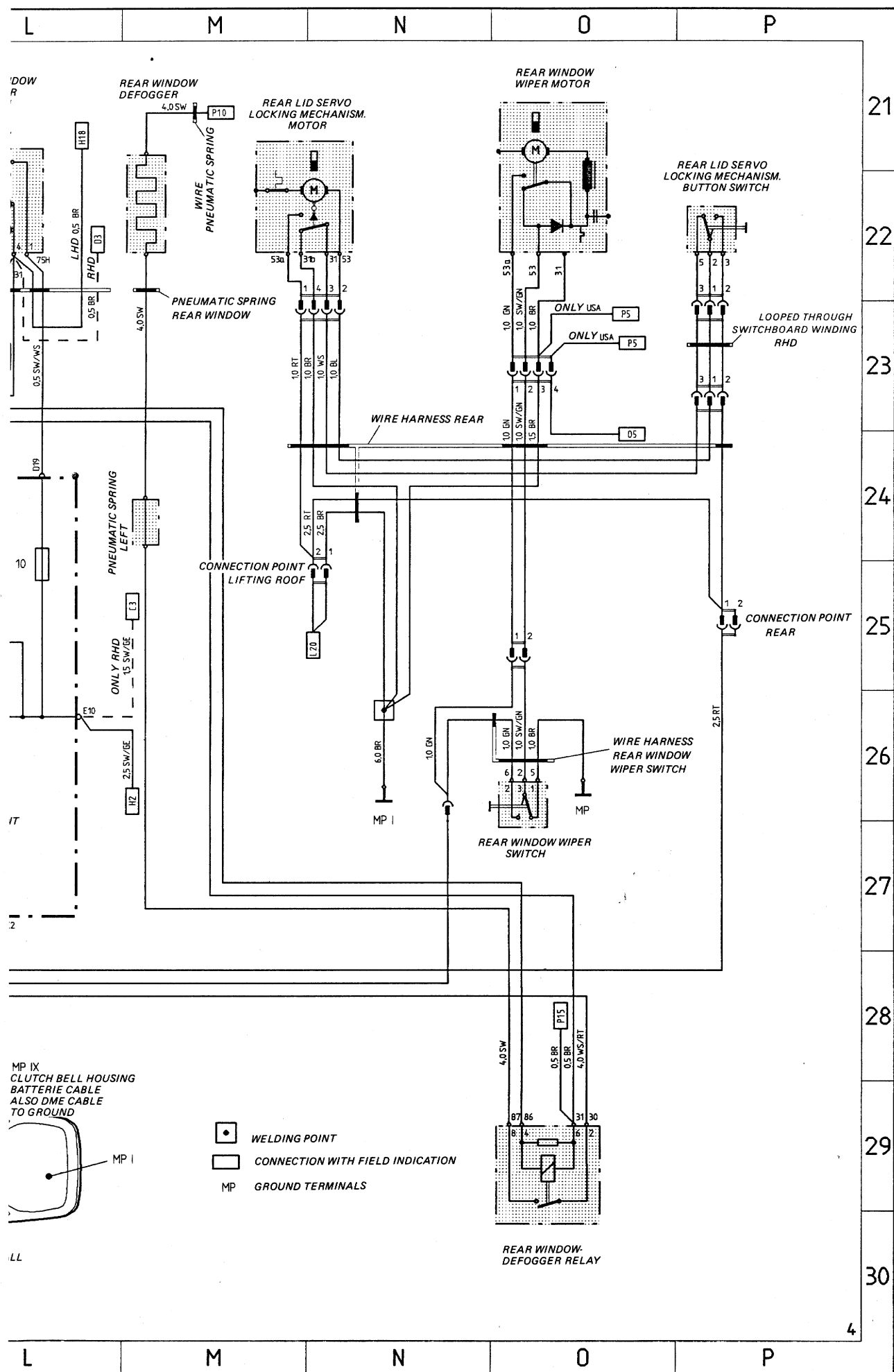

Wiring Diagram Type 924 S Model 87 Sheet 5

AC, WINDOW LIFTERS, ALARM SYSTEM

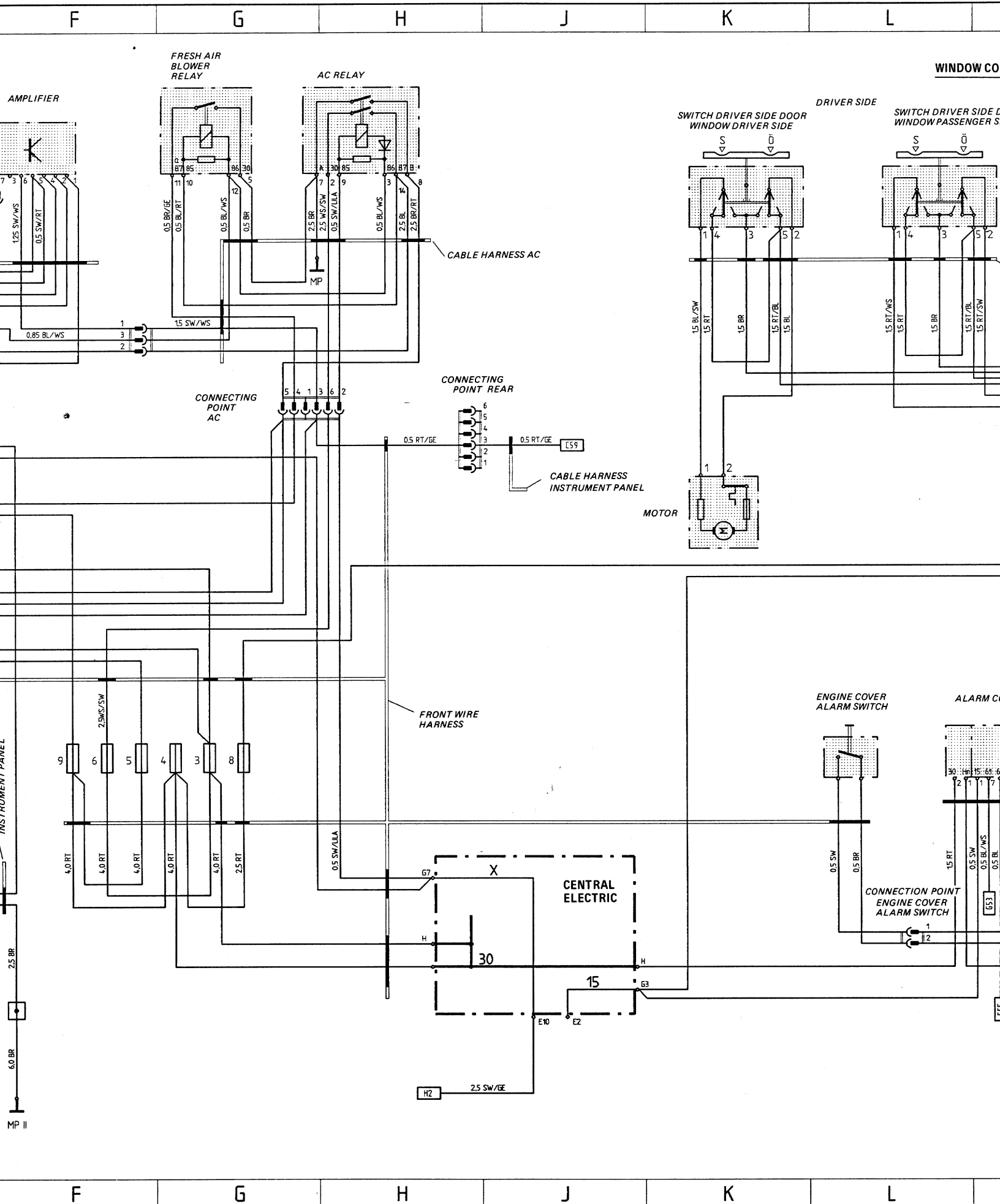

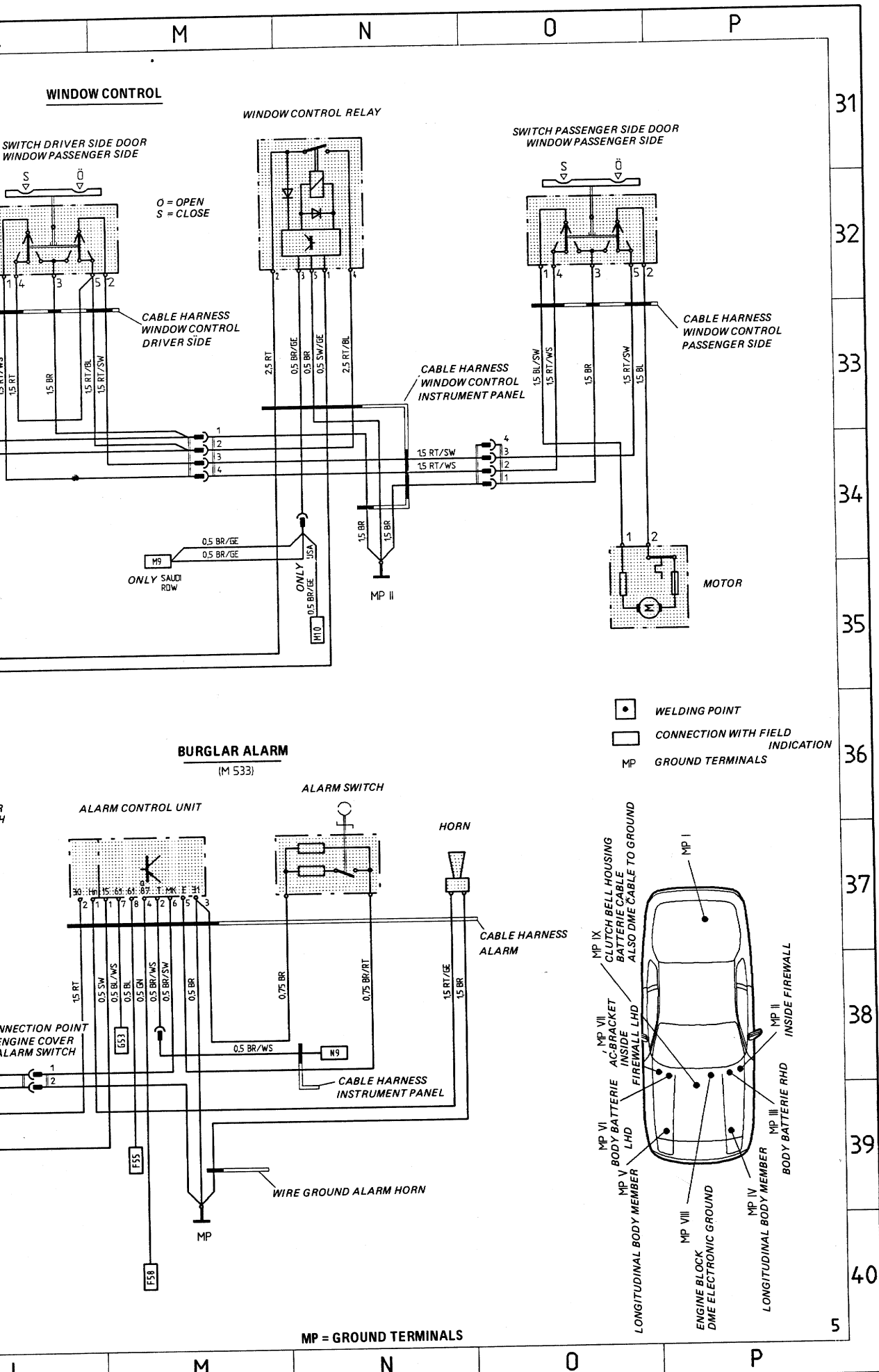

Wiring Diagram Type 924 S Model 87 Sheet 6

AC RHD

Wiring Diagram Type 924 S Model 87 Sheet 6

AC RHD

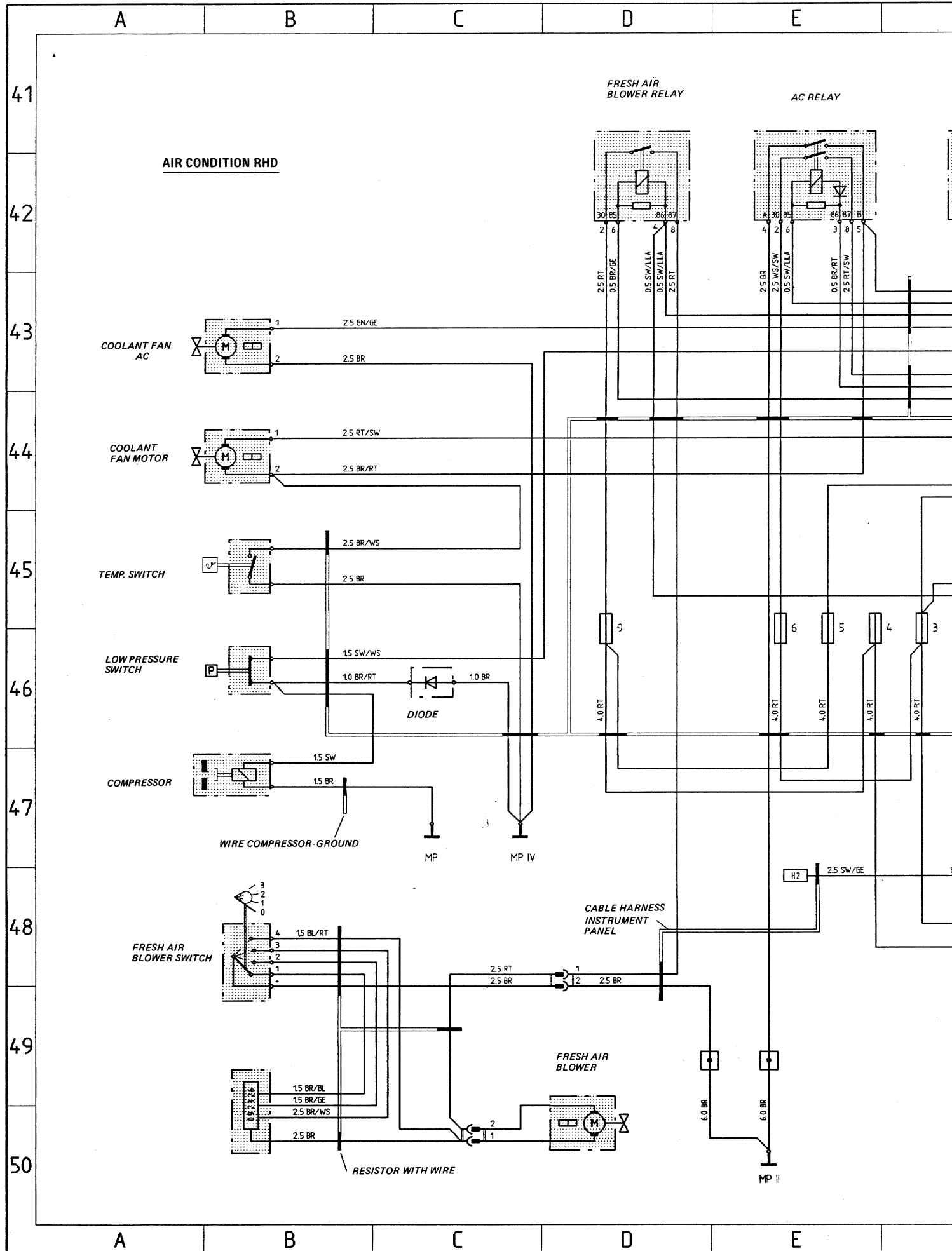

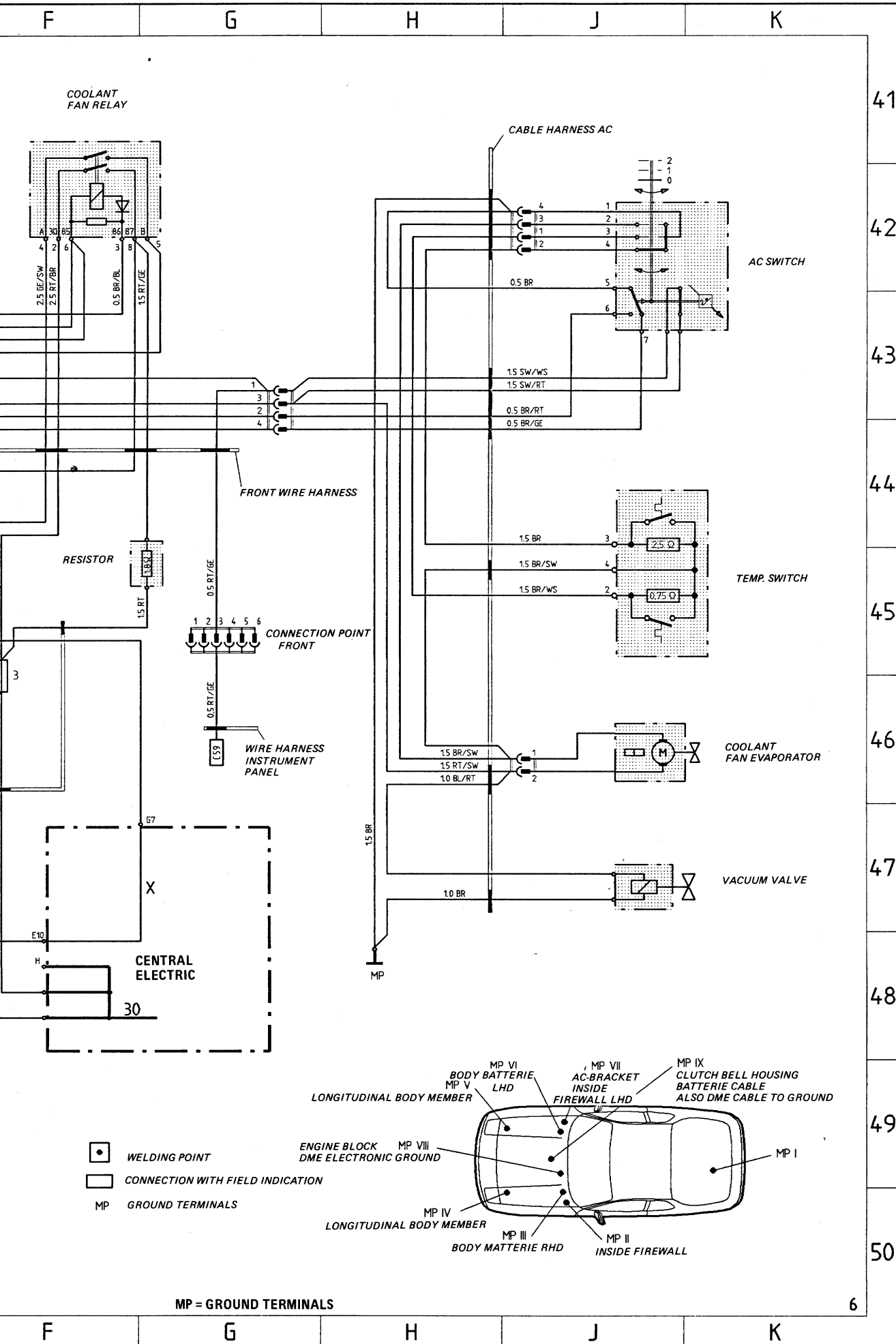

Wiring Diagram Type 924 S Model 87 Sheet 7

ENGINE, TEMPOSTAT

Wiring Diagram Type 924 S Model 87 Sheet 7

ENGINE, TEMPOSTAT

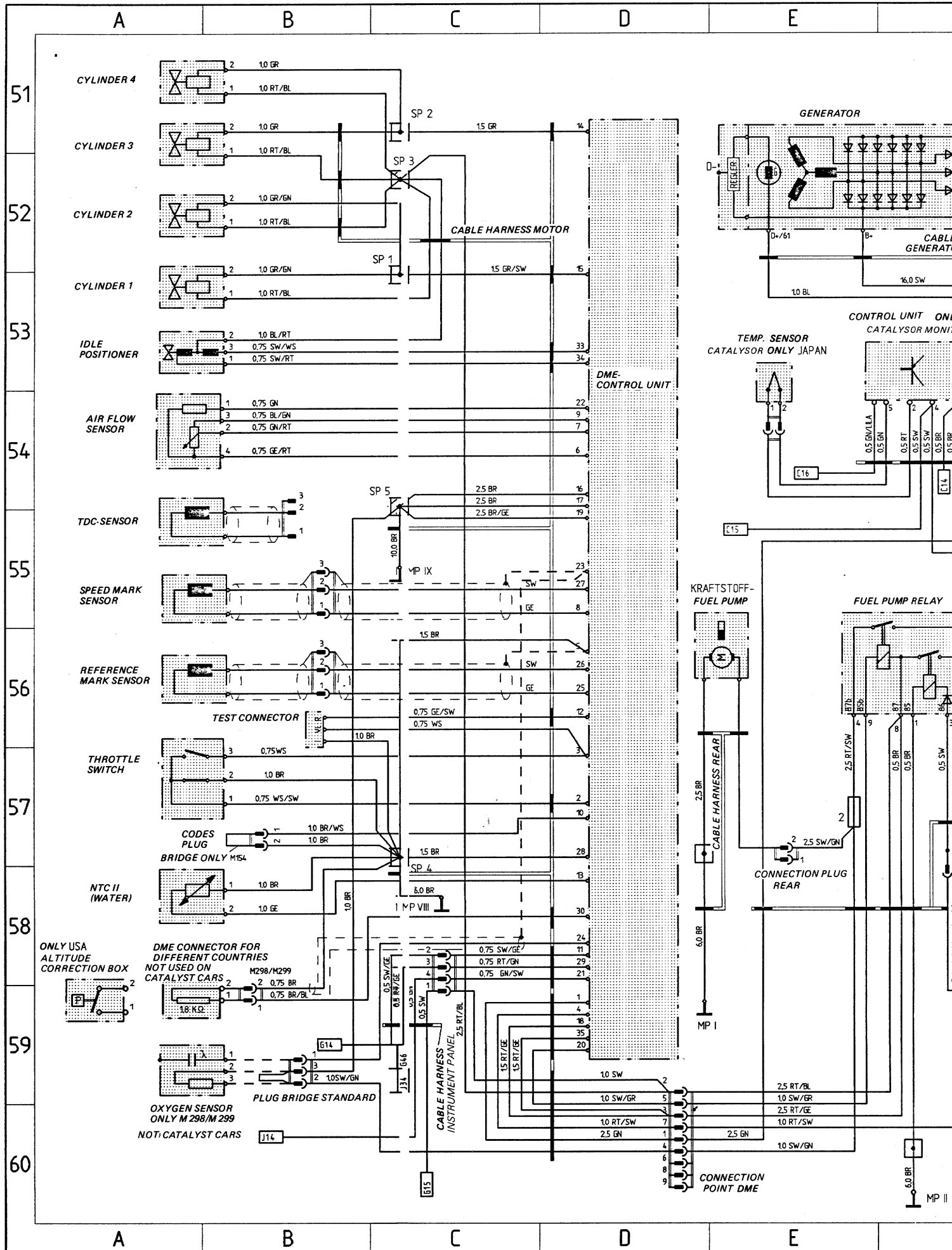

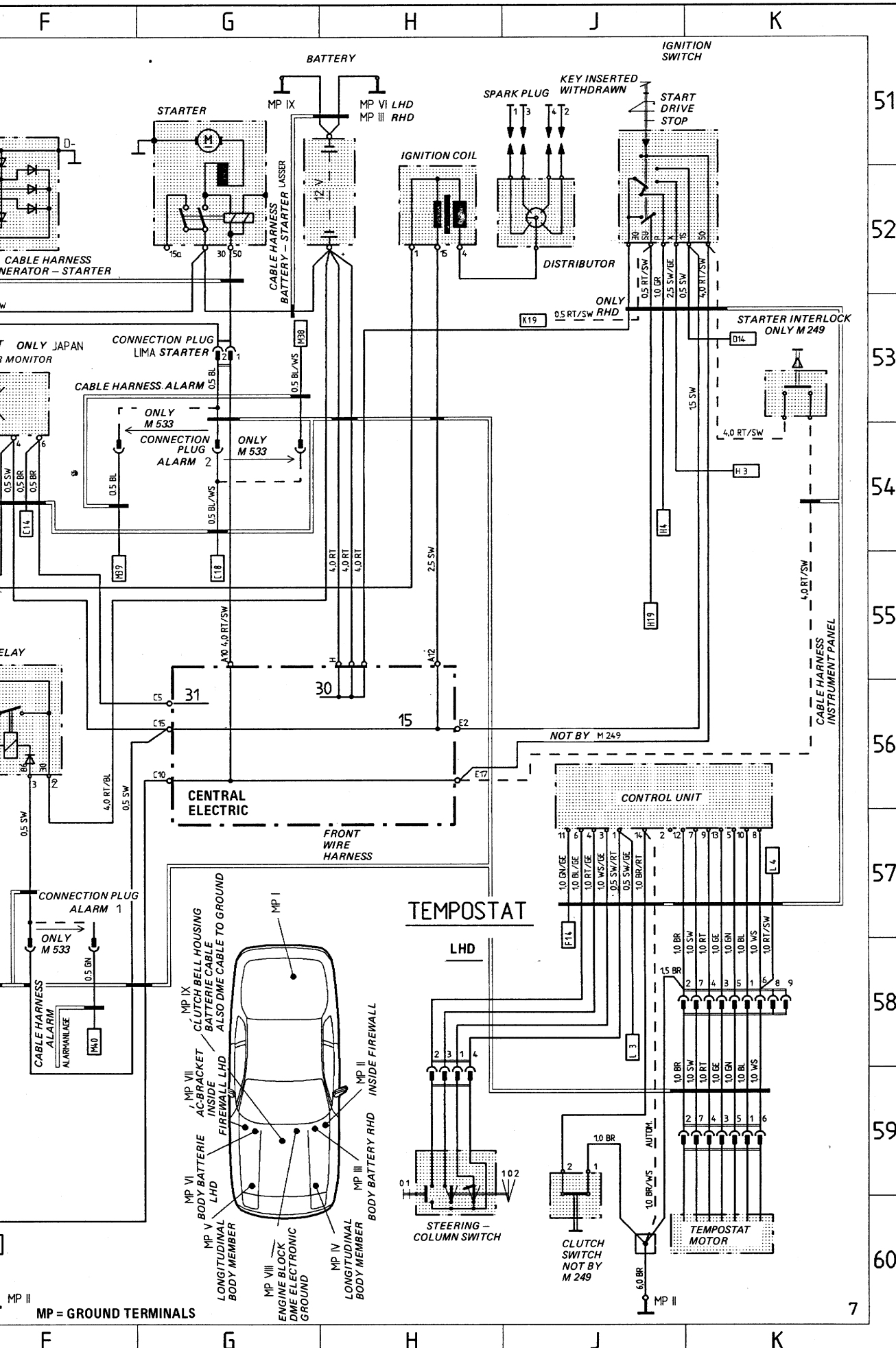

51
52
53
54
55
56
57
58
59
60

MP = GROUND TERMINALS

7

Wiring Diagram Type 924 S Model 87 Sheet 8

CENTRAL ELECTRICAL SYSTEM

ADDITIONAL RELAY

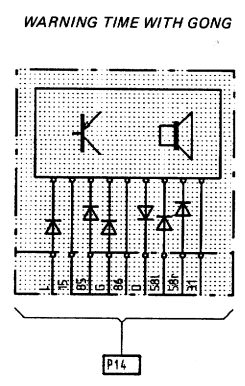
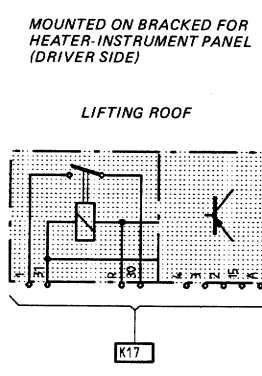
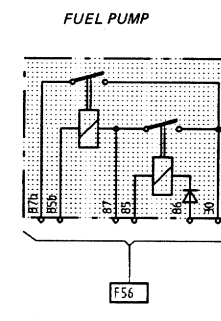
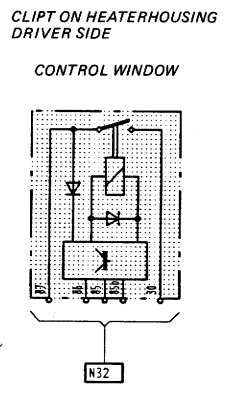
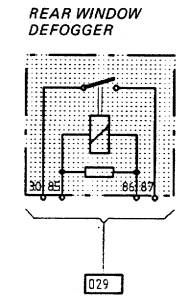
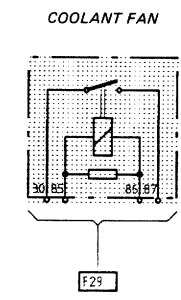
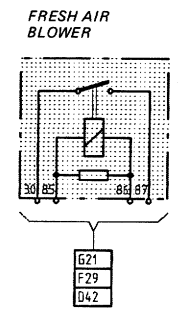
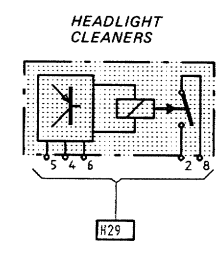
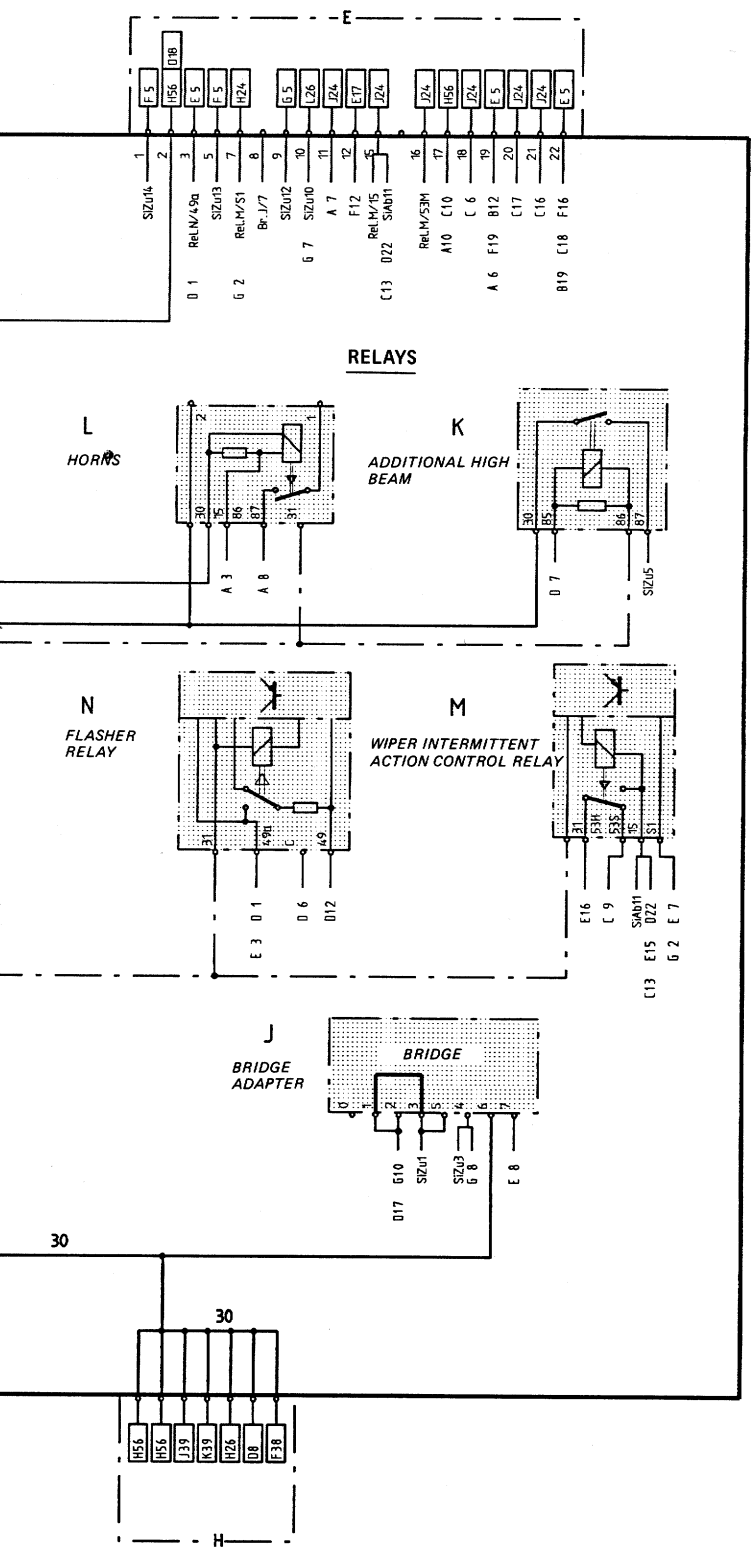

RELAY P-U ARE CLIP ON CENTRAL ELECTRIC SYSTEM

MP = GROUND TERMINALS

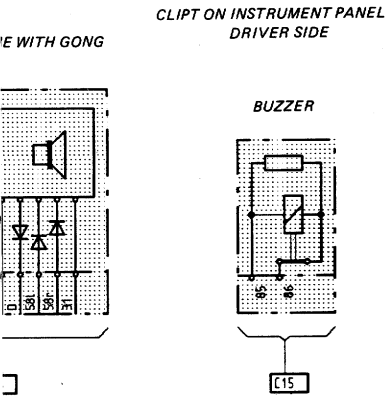
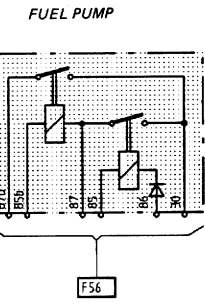
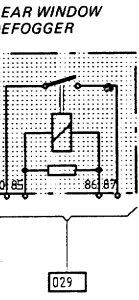
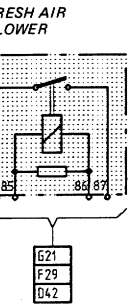
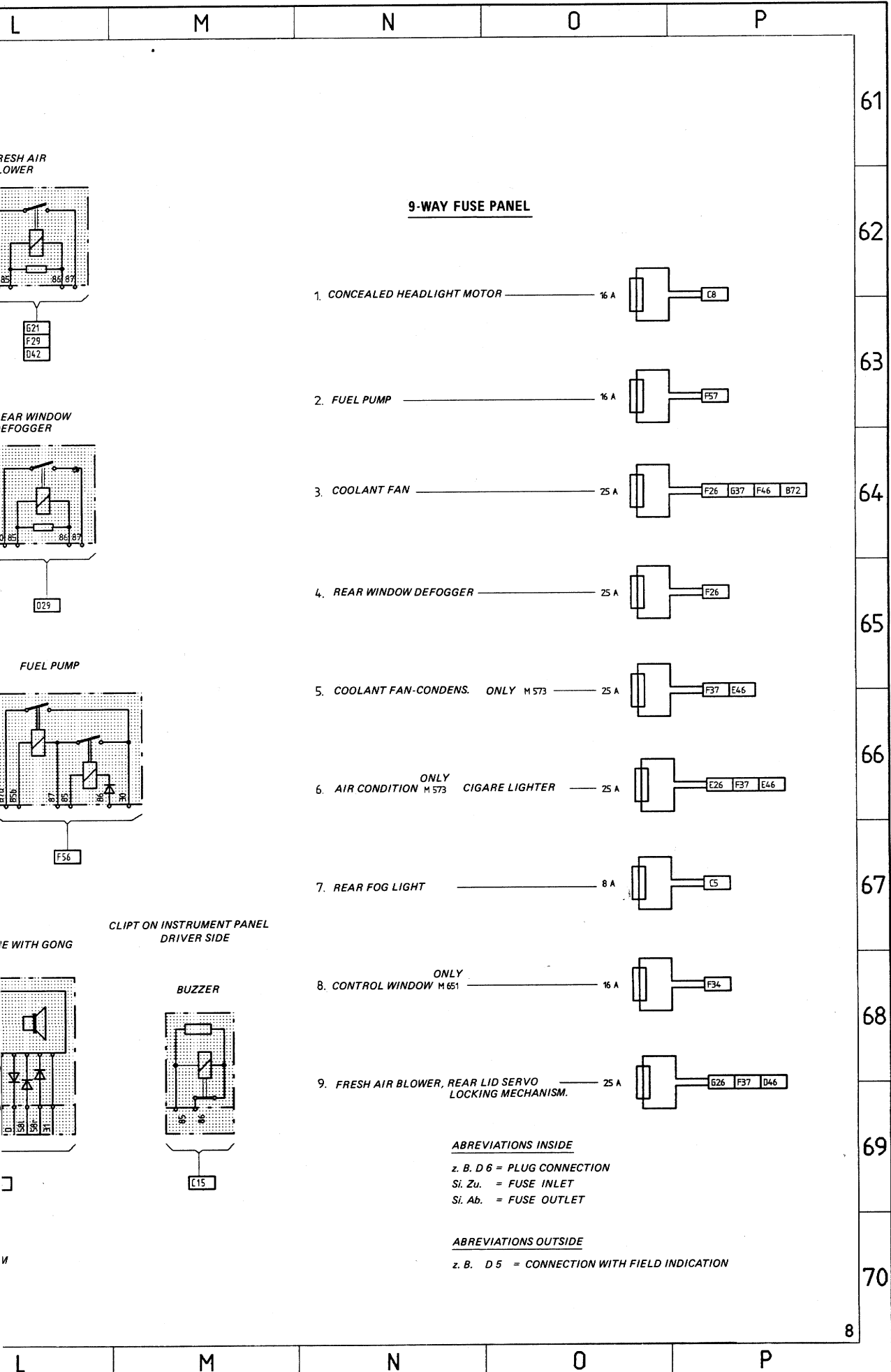

Wiring Diagram Type 924 S
Model 87 Sheet 9

RADIO

Wiring Diagram Type 924 S Model 87 Sheet 9

RADIO

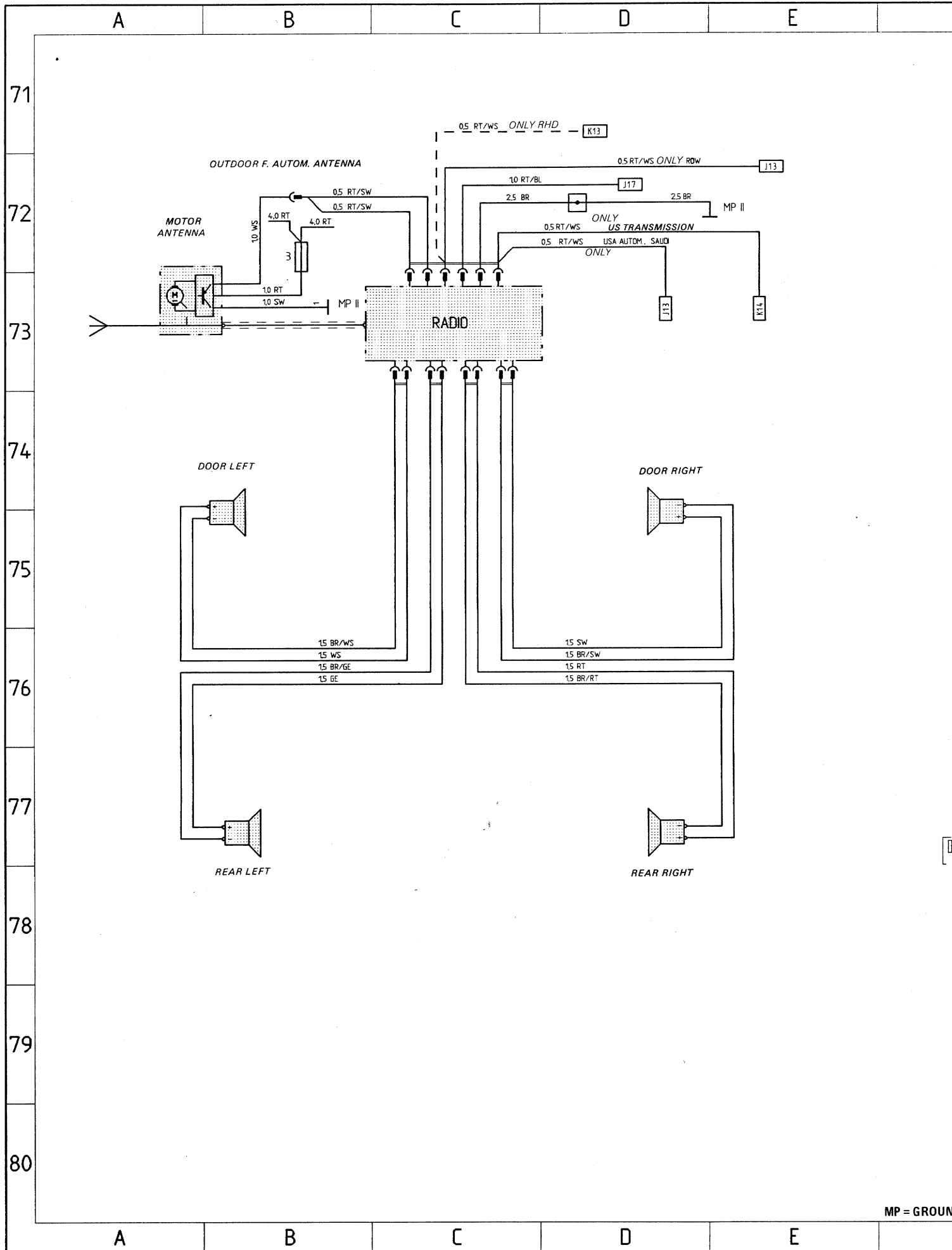

MP = GROUND

F G H J K

71

72

73

74

75

76



77

78

79

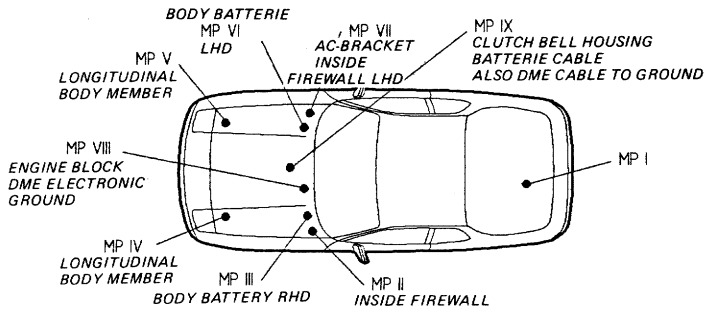
80



-  WELDING POINT
-  CONNECTION WITH FIELD INDICATION
- MP GROUND TERMINALS

CONNECTORS RADIO

ONLY Toronto SQR 32

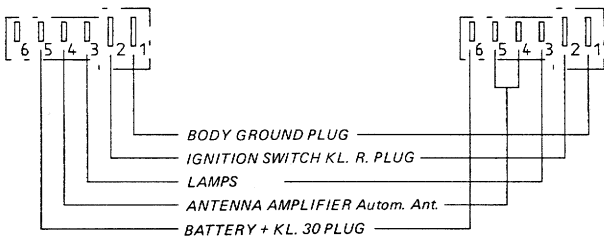

SPEAKER CONNECTORS

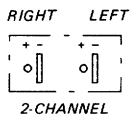
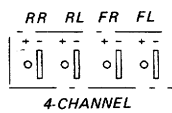

GROUND TERMINALS

F G H J K

9